

**MANUALE USO E MANUTENZIONE
USE AND MAINTENANCE MANUAL
LIVRET D'UTILISATION ET D'ENTRETIEN
MANUAL DE USO Y MANTENIMIENTO
MANUAL DE USO E MANUTENÇÃO
ΟΔΗΓΟΣ ΧΡΗΣΗΣ ΚΑΙ ΣΥΝΤΗΡΗΣΗΣ
KULLANIM VE BAKIM KILAVUZU
NAVODILA ZA UPORABO IN VZDRŽEVANJE
PRIROČNIK ZA UPORABO IN VZDRŽEVANJE**

**Unita di Potenza
Power unit
Unite de puissance
Grupo de potencia
Unidade de potência
Μονάδα ισχύος
Alice güc ünitesi
Elektrický motor
Električni motor**

ENERGY4



IMPORTED – EXTRA EU

Italiano	4
English	23
Français	42
Español	61
Português	80
Ελληνικά	99
Türkçe	118
Slovenščina	137
Hrvatski	156

Grazie per aver scelto un Generatore Campagnola by RATO.

Questo manuale contiene le informazioni su come utilizzarlo. Si prega di leggerlo attentamente prima dell'uso. Operare in modo sicuro e corretto può aiutarvi ad ottenere i migliori risultati.

Tutte le informazioni contenute in questa pubblicazione si basano sulle informazioni sui prodotti più recenti disponibili al momento della stampa. Il contenuto di questo manuale può differire dalle parti effettive a causa di revisioni e altre modifiche.

La nostra azienda si riserva il diritto di apportare modifiche in qualsiasi momento senza preavviso e senza incorrere in alcun obbligo. Nessuna parte di questa pubblicazione può essere riprodotta senza il permesso scritto della nostra azienda.

Questo manuale deve essere considerato parte permanente del Generatore e deve accompagnare il Generatore in caso di rivendita.

AVVERTENZE SULLA SICUREZZA

AVVISO!

La sicurezza personale e la sicurezza della proprietà vostra e di altri sono molto importanti. Si prega di leggere attentamente i messaggi preceduti dal simbolo.

PERICOLO!

Sussiste il rischio di DECESSO o di LESIONI gravi se non vengono rispettate le istruzioni.

AVVERTENZA!

Sussiste il pericolo di DECESSO o di LESIONI gravi se non vengono rispettate le istruzioni.

ATTENZIONE!

Sussiste il pericolo di LESIONI se non vengono rispettate le istruzioni.

AVVISO!

Il Generatore o altri beni potrebbero essere danneggiati in caso di mancato rispetto delle istruzioni.

SOMMARIO

AVVERTENZE SULLA SICUREZZA	4
1 INDICAZIONI DI SICUREZZA	6
2 POSIZIONE DELLE ETICHETTE IMPORTANTI	8
3 DESCRIZIONE	9
3.1 Pannello di controllo.....	9
4 CONTROLLO DELLE FUNZIONI	10
4.1 Valvola del carburante.....	10
4.2 Leva di avviamento.....	10
4.3 Spia olio (rossa).....	10
4.4 Spia di sovraccarico (rosso).....	11
4.5 Spia pilota AC (verde).....	11
4.6 Protezione DC.....	11
4.7 Interruttore Generatore.....	11
4.8 Interruttore Intelligente (C).....	12
4.9 Tappo serbatoio carburante.....	12
4.10 Manopola di sfiato dell'aria sul tappo del serbatoio del carburante.....	12
4.11 Terminale di terra.....	12
5 PREPARAZIONE	13
5.1 Carburante.....	13
5.2 Rifornimento Carburante.....	13
5.3 Olio motore.....	13
5.4 VERIFICA PRIMA DELL'UTILIZZO.....	14
6 FUNZIONAMENTO	14
6.1 Avvio del motore.....	14
6.2 Arresto del motore.....	15
6.3 Collegamento in corrente alternata (AC).....	15
6.4 Campo di applicazione.....	16
7 MANUTENZIONE	17
7.1 Ispezione candela.....	18
7.2 Regolazione carburatore.....	18
7.3 Sostituzione olio motore.....	18
7.4 Filtro dell'aria.....	18
7.5 Schermo del silenziatore e parascintille.....	19
7.6 Filtro serbatoio carburante.....	19
8 CONSERVAZIONE	20
8.1 Scarico del carburante.....	20
9 RISOLUZIONE DEI PROBLEMI	20
10 SPECIFICHE TECNICHE	21
11 DEMOLIZIONE E SMALTIMENTO DEI COMPONENTI	21
11.1 Smaltimento materiali esausti.....	21
11.2 Indicazioni per rifiuti speciali.....	22

1 INDICAZIONI DI SICUREZZA

Leggere e comprendere questo manuale d'uso prima di mettere in funzione il Generatore. La conoscenza delle procedure di funzionamento sicuro del Generatore vi aiuterà ad evitare possibili incidenti.

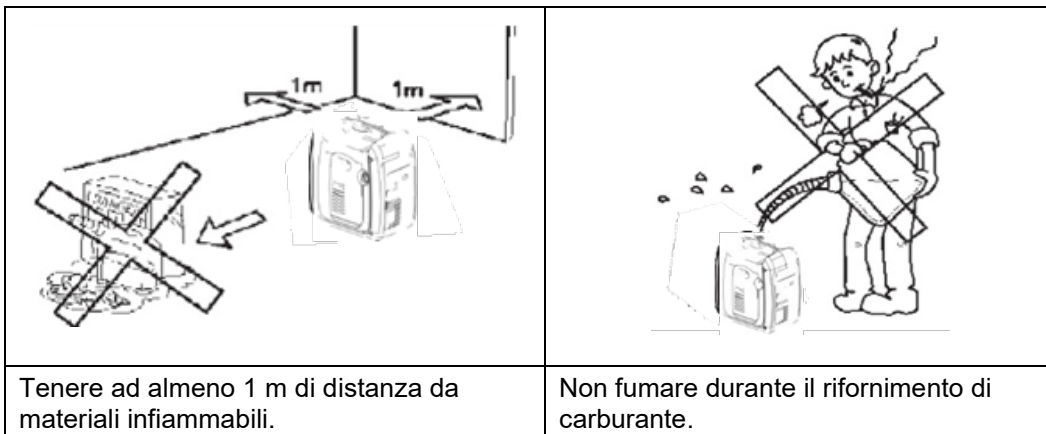
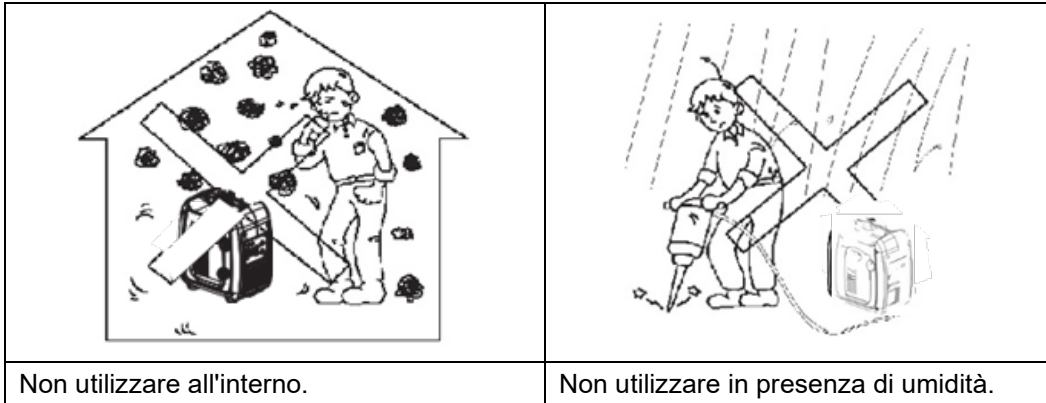

AVVISO! Collegamento all'alimentazione elettrica domestica.

Se il Generatore deve essere collegato ad un'alimentazione elettrica domestica, il collegamento deve essere effettuato da un elettricista professionista o da un'altra persona con competenze elettriche adeguate.

Quando i carichi sono collegati al Generatore, verificare attentamente se i collegamenti elettrici sono sicuri e affidabili. Un collegamento improprio può causare danni al Generatore o provocare un incendio.



PERICOLO! Il Generatore NON è un caricabatterie e non può essere assolutamente usato come tale poiché non dotato di alcun sistema di controllo e protezione della corrente erogata.

L'utilizzo come caricabatterie **NON È PERMESSO E VIETATO DAL FABBRICANTE**, è pericoloso e può danneggiare la batteria, il generatore, in caso di incendio può causare gravi lesioni.

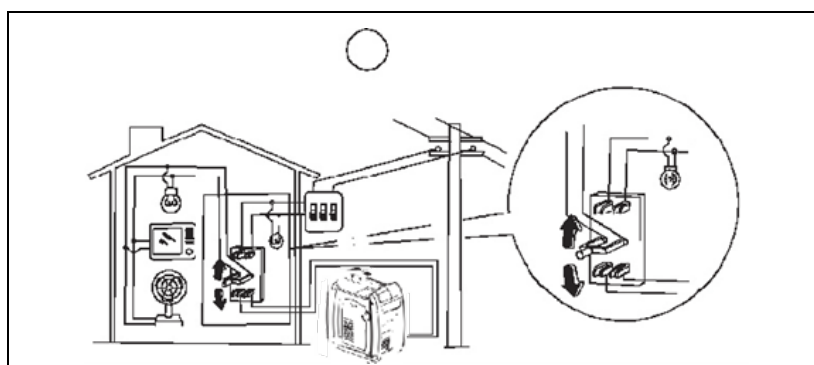
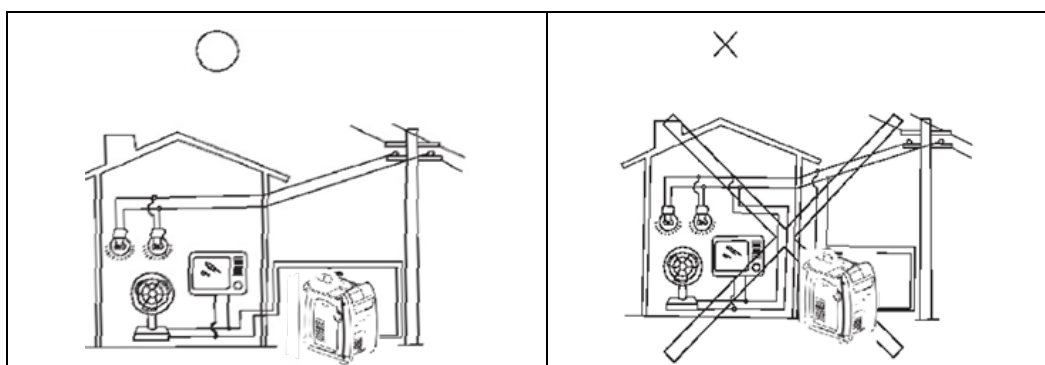

Circuito di messa a terra del Generatore

Per evitare scosse elettriche dovute ad apparecchi elettrici scadenti o ad un uso errato dell'elettricità, il Generatore deve essere messo a terra con un conduttore isolato di buona qualità.

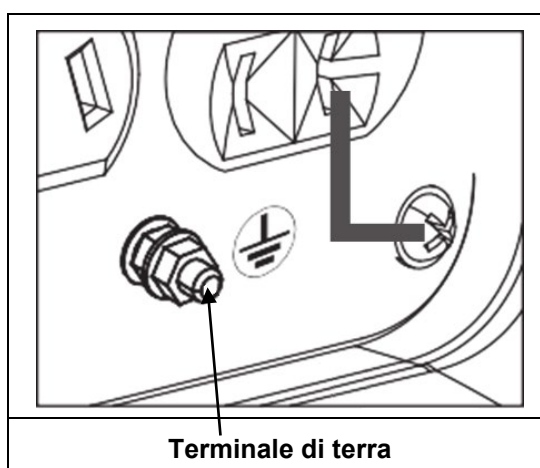

AVVISO!

Accertarsi che il pannello di controllo, la presa d'aria e il lato inferiore dell'inverter si raffreddino bene e che non vi siano impurità, fango e acqua. In caso di blocco dello sfiato di raffreddamento si possono danneggiare il motore, l'inverter o l'alternatore.

Non accatastare il Generatore con altri oggetti in caso di spostamento, messa a riposo o funzionamento dell'unità. Ciò può causare danni al Generatore o compromettere la sicurezza della proprietà se il Generatore presentasse delle perdite.



2 POSIZIONE DELLE ETICHETTE IMPORTANTI

ATTENZIONE!

Leggere attentamente le seguenti tabelle prima di utilizzare questa macchina.

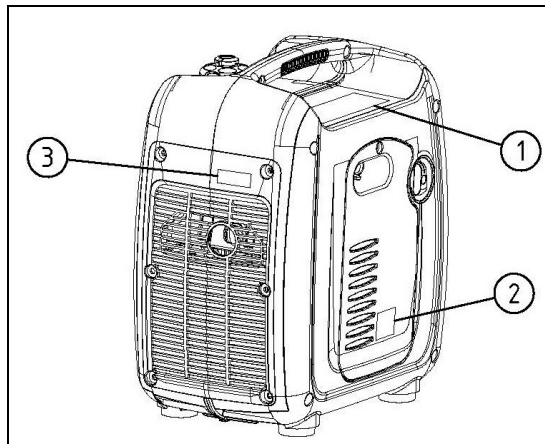
CONSIGLIO: Mantenere o sostituire le etichette di istruzioni e sicurezza, se necessario.



 WARNING	
1	<ul style="list-style-type: none">● Read the owner's manual and all labels before operating.● Only operate in well-ventilated areas. Exhaust gas contains poisonous carbon monoxide.● Check for spilled fuel or fuel leaks.● Stop engine before refueling.● Do not operate near flammable materials.● Electrocutation can occur if generator is used in rain, snow, or near water. Keep this unit dry at all times.● Electrocutation or property damage can occur. Do not connect this generator to any building's electrical system unless an isolation switch has been installed by a licensed electrician. Refer to the owner's manual.● When operating the generator:<ul style="list-style-type: none">Never place a partition or other barrier around the generator.Do not cover the generator with a box.Do not place any objects on the generator.● Turn the fuel tank cap air vent knob to "OFF" after the engine has completely cooled down.
2	
3	

3 DESCRIZIONE

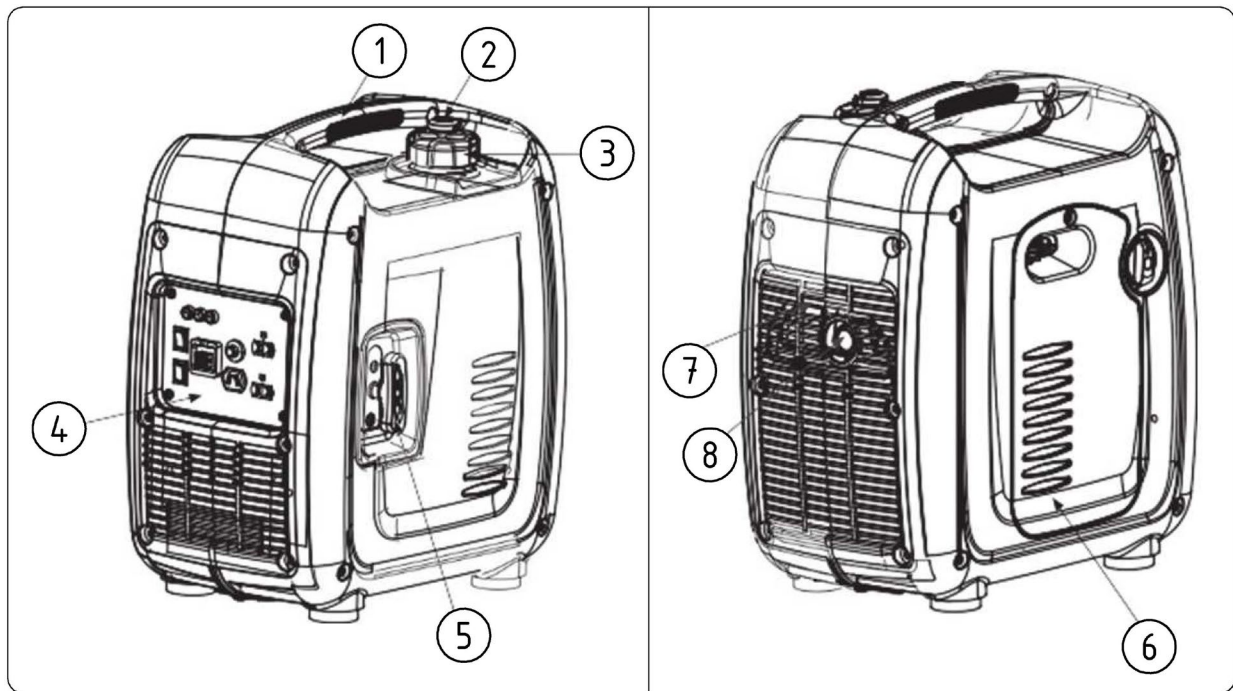

Pos.	Denominazione
1	Maniglia di trasporto
2	Manopola di sfiato dell'aria sul tappo del serbatoio del carburante
3	Tappo serbatoio carburante
4	Pannello di controllo
5	Avviatore a strappo
6	Tappo di riempimento dell'olio
7	Presca d'aria
8	Silenziatore

3.1 Pannello di controllo

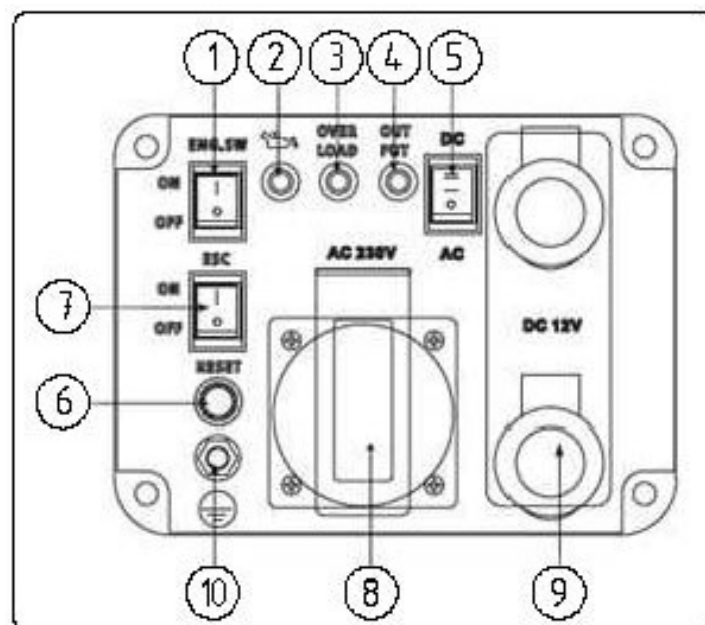

Pos.	Denominazione
1	Interruttore Generale
2	Spia dell'olio
3	Spia di Sovraccarico
4	Spia pilota AC
5	Interruttore AC/DC (AC Corrente alternata, DC Corrente continua)
6	AC Reset
7	ESC (Controllo intelligente del motore)
8	Presca AC
9	Connessioni (+/-) DC
10	Terminale di Terra

4 CONTROLLO DELLE FUNZIONI

4.1 Valvola del carburante

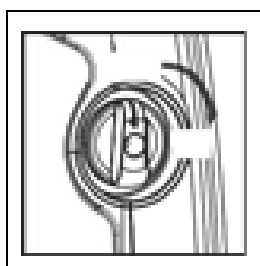

La valvola del carburante controlla il flusso di carburante dal serbatoio al carburatore. Assicurarsi di riportare la leva su "OFF" dopo l'arresto del motore.

4.2 Leva di avviamento

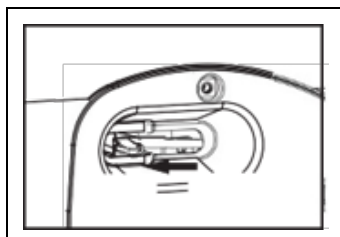

La leva di avviamento serve per fornire una miscela di carburante arricchito quando si avvia un motore freddo. Portare lentamente la leva di avviamento in posizione "APERTO" dopo che il motore è stato avviato.

CONSIGLIO: Lo starter non è necessario per avviare un motore caldo.

4.3 Spia olio (rossa)



Quando il livello dell'olio scende sotto il minimo si accende la spia ①, il motore si arresta automaticamente. Se non viene ripristinato il livello dell'olio, il motore non si riavvia.

CONSIGLIO: Se il motore si blocca o non si avvia, posizionare l'interruttore del motore su "ON" e tirare l'avviamento a strappo. Se la spia dell'olio lampeggia per alcuni secondi, significa che l'olio motore è insufficiente. Aggiungere olio e riavviare.

4.4 Spia di sovraccarico (rosso)

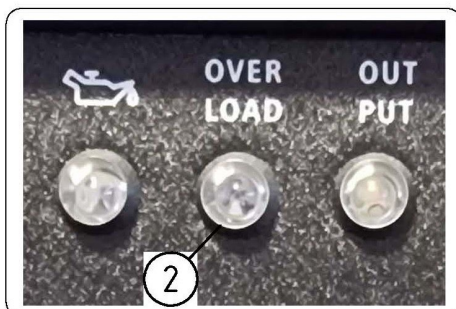

La spia di sovraccarico ② si accende quando viene rilevato un sovraccarico di un dispositivo elettrico collegato, la centralina dell'inverter si surriscalda o la tensione di uscita AC aumenta. Quindi, la protezione AC scatterà, interrompendo la generazione di energia al fine di proteggere il Generatore e gli eventuali dispositivi elettrici collegati. La spia pilota AC (verde) si spegne e la spia di sovraccarico (rossa) rimane accesa, ma il motore non si ferma.

Quando si accende la spia di sovraccarico e la produzione di energia elettrica si arresta, procedere come segue:

1. Spegner tutti i dispositivi elettrici collegati e arrestare il motore.
2. Ridurre la potenza totale dei dispositivi elettrici collegati entro l'intervallo della potenza nominale.
3. Controllare che non vi siano ostruzioni all'ingresso dell'aria di raffreddamento e intorno all'unità di controllo, se si riscontrano dei blocchi, rimuoverli.
4. Dopo avere controllato, riavviare il motore.

Consiglio: La spia di sovraccarico può accendersi per alcuni secondi all'inizio, quando si utilizzano dispositivi elettrici che richiedono una grande corrente di avviamento, come ad esempio un compressore o una pompa a immersione. Tuttavia, non si tratta di un malfunzionamento.

4.5 Spia pilota AC (verde)

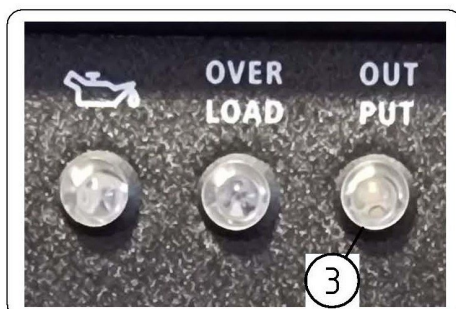

La spia pilota AC ③ si accende quando il motore si avvia e produce potenza.

4.6 Protezione DC

4.7 Interruttore Generatore

① - **On:** Avviare il Generatore

② - **Off:** Arrestare Generatore

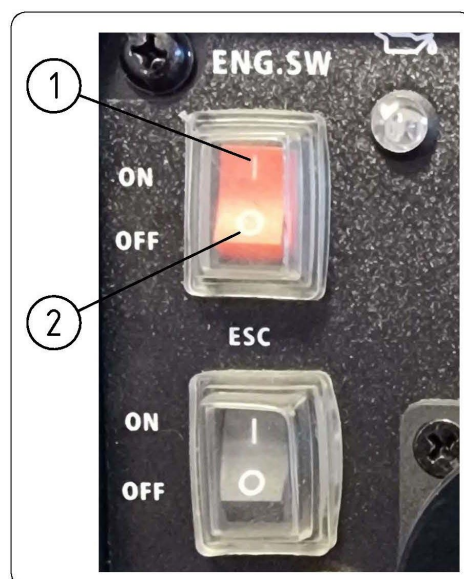

4.8 Interruttore Intelligente (C)

La funzione intelligente se abilitata (interruttore su **1 "ON"**) permette al motore di girare al minimo con un consumo di carburante ridotto, in condizioni di assenza o poco carico; all'aumentare del carico, aumentano anche i giri del motore per fornire più potenza.

Con la funzione intelligente disabilitata (interruttore su **0 "OFF"**) il motore è sempre al massimo dei giri per fornire da subito la massima potenza, questa funzione è utile quando si devono avviare degli utensili elettrici con grossi assorbimenti all'avvio.

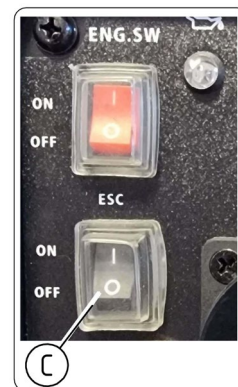

4.9 Tappo serbatoio carburante

Rimuovere il tappo del serbatoio del carburante ruotandolo in senso antiorario.

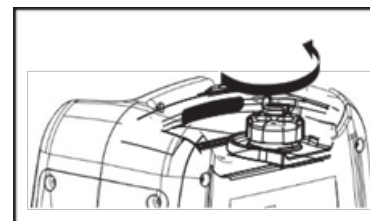

4.10 Manopola di sfiato dell'aria sul tappo del serbatoio del carburante

Il tappo del serbatoio del carburante (2) è dotato di una manopola di sfiato dell'aria per (1) arrestare il flusso di carburante.

La manopola di sfiato dell'aria deve essere posizionata su **"ON"**. Questo permetterà al carburante di fluire nel carburatore e al motore di funzionare.

Quando il motore non è in uso, ruotare la manopola di sfiato dell'aria su **"OFF"** per arrestare il flusso di carburante.

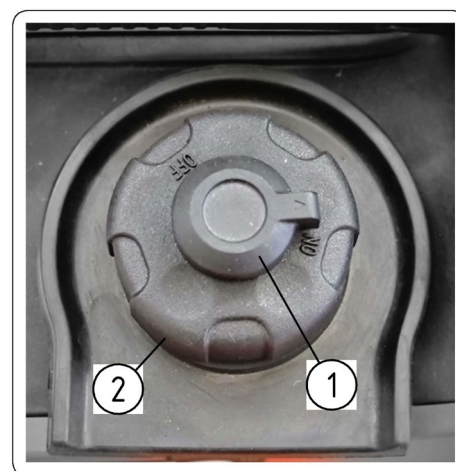

4.11 Terminale di terra

Terminale di terra (1)



ATTENZIONE!

Da collegare esclusivamente nel caso si utilizzi il Generatore collegato alla rete in corrente alternata a 220 V.



5 PREPARAZIONE

5.1 Carburante



ATTENZIONE!

Il carburante è altamente infiammabile e velenoso. Leggere con attenzione le "INFORMAZIONI DI SICUREZZA" con attenzione prima del riempimento.

- Non riempire eccessivamente il serbatoio del carburante, altrimenti potrebbe traboccare quando il carburante si riscalda e si espande.
- Dopo avere riempito il serbatoio del carburante, assicurarsi che il tappo del serbatoio del carburante sia ben stretto.



AVVISO!

- Pulire immediatamente il carburante versato con un panno morbido, pulito e asciutto, poiché il carburante potrebbe deteriorare le superfici verniciate o le parti in plastica.
- Utilizzare solo benzina senza piombo. L'uso di benzina con piombo provoca gravi danni alle parti interne del motore.

5.2 Rifornimento Carburante



ATTENZIONE!

Il carburante è altamente infiammabile e velenoso. Leggere con attenzione le "INFORMAZIONI DI SICUREZZA" prima del riempimento.

- Non riempire eccessivamente il serbatoio del carburante, altrimenti potrebbe traboccare quando il carburante si riscalda e si espande.
- Dopo avere riempito il serbatoio del carburante, assicurarsi che il tappo del serbatoio del carburante sia ben stretto



ATTENZIONE!

- Pulire immediatamente il carburante versato con un panno morbido, pulito e asciutto, poiché il carburante potrebbe deteriorare le superfici verniciate o le parti in plastica.
- Utilizzare solo benzina senza piombo. L'uso di benzina con piombo provoca gravi danni alle parti interne del motore.



AVVISO!

Per effettuare il rifornimento, rimuovere il tappo del serbatoio del carburante e riempire il serbatoio fino al livello rosso ①.

Carburante raccomandato:

Benzina senza piombo

Capacità del serbatoio del carburante:

Totale: 2.5L



5.3 Olio motore



ATTENZIONE!

Il Generatore viene spedito senza olio motore. Non avviare il motore fino a quando non è stato riempito con una quantità sufficiente di olio motore.



- Posizionare il Generatore su una superficie piana.
- Rimuovere le viti ①, quindi rimuovere il coperchio ②.
- Rimuovere il tappo di riempimento dell'olio ③.
- Riempire la quantità specificata dell'olio motore consigliato, montare nuovamente il tappo dell'olio ③.
- Montare nuovamente il coperchio ②, stringere la vite ①.

Olio motore raccomandato:	SAE SJ 15W-40
Grado olio motore raccomandato:	Tipo API Service SE o superiore
Quantità olio motore:	0.31 L

5.4 VERIFICA PRIMA DELL'UTILIZZO



AVVISO!

- Prima di avviare il Generatore verificare che sia integro in tutte le sue parti, se danneggiato farlo riparare prima di metterlo in funzione, i componenti vitali possono iniziare a deteriorarsi rapidamente e inaspettatamente, anche se il Generatore non viene utilizzato.
- La verifica della condizione di un Generatore è di responsabilità del proprietario.
- I controlli prima dell'utilizzo devono essere effettuati ogni volta che il Generatore viene utilizzato.
- Prima dell'utilizzo verificare il livello del **Carburante** (vedi par. 5.2), se necessario rabboccare.
- Prima dell'utilizzo verificare il livello dell'**Olio motore** (vedi par. 5.3), se necessario rabboccare.
- Prima dell'utilizzo controllare che il Generatore non presenti perdite d'olio.

In caso di anomalie non descritte nel seguente manuale, rivolgersi presso un'officina autorizzata.

6 FUNZIONAMENTO



ATTENZIONE!

Non azionare mai il motore in un'area chiusa in quanto le emissioni dei gas di scarico potrebbero causare perdita di coscienza e perfino la morte in breve tempo. Far funzionare il motore in un'area ben ventilata.

- Prima che il Generatore sia avviato, non collegare nessun dispositivo elettrico.
- Il Generatore viene spedito senza olio motore, non avviare il motore fino a quando non è stato riempito con la quantità indicata (vedi par. 5.3).
- Non inclinare il Generatore quando si aggiunge olio motore, questo potrebbe causare un eccessivo riempimento e danneggiare il motore.
- Il Generatore può essere utilizzato con il carico nominale in uscita in condizioni atmosferiche standard:
 - Temperatura ambiente: 25°C
 - Pressione barometrica: 100kPa
 - Umidità relativa: 30%.
- La potenza del Generatore varia a seconda del cambiamento di temperatura, dell'altitudine (pressione dell'aria più bassa ad alta quota) e dell'umidità.
- La potenza del Generatore si riduce quando la temperatura, l'umidità e l'altitudine sono superiori alle condizioni atmosferiche standard.
- Il carico deve essere ridotto quando viene utilizzato in spazi ristretti, poiché il raffreddamento del Generatore ne risente.

6.1 Avvio del motore

- 1- Posizionare la manopola di sfiato su "On" ①

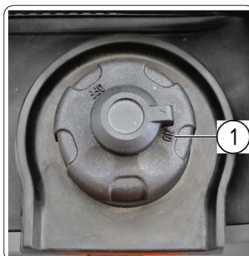

- 2- Ruotare il rubinetto del carburante ② in posizione A;
- 3- Spostare la leva dello Starter ③ in posizione B;

Il Generatore è pronto per essere avviato.



AVVISO!

Per avviare il Generatore col motore caldo, la leva dello starter deve rimanere in posizione “**OPEN**”.

- 4- Tirare lentamente la maniglia ② di avviamento autoavvolgente fino a quando non viene innestato, quindi tirarlo rapidamente per avviare il motore.



ATTENZIONE!

Afferrare saldamente la maniglia di trasporto ② per evitare che il Generatore cada quando si tira l'avviamento autoavvolgente.

- 5- Dopo qualche minuto di funzionamento del motore, riportare la leva dello starter in posizione **OPEN**.

6.2 Arresto del motore

AVVISO!

- Prima di arrestare il motore del Generatore, spegnere tutti i dispositivi elettrici collegati.
- Portare l'interruttore del Generatore in posizione “**OFF**” (vedi par. 4.7).
- Ruotare il rubinetto del carburante in posizione “**0**” **CLOSE**.

Il circuito di accensione è spento, il carburante è chiuso.



- Dopo che il motore si è completamente raffreddato, ruotare la manopola di sfiato dell'aria su “**OFF**” - 1.



6.3 Collegamento in corrente alternata (AC)

ATTENZIONE!

- Assicurarsi che tutti i dispositivi elettrici siano spenti prima di collegarli al Generatore.
- Assicurarsi che tutti i dispositivi elettrici, compresi i cavi e i connettori a spina, siano in buone condizioni prima di collegarli al Generatore.
- Assicurarsi che il carico totale rientri nella potenza nominale del Generatore.
- Assicurarsi che la corrente di carico della presa rientri nella corrente nominale della presa.

NOTA: se il Generatore collegato alla rete in corrente alternata a 220 V, anche il Generatore dev'essere collegato a terra tramite il terminale di Terra (vedi par. 4.11).



⚠ ATTENZIONE!

Quando si utilizzano degli utensili a 12 V, l'interruttore intelligente "ESC" (vedi par. 4.8) dev'essere tassativamente in posizione 1 "ON").

6.4 Campo di applicazione

⚠ ATTENZIONE!

Quando si utilizza il Generatore, assicurarsi che il carico totale rientri nella potenza nominale del Generatore. In caso contrario, possono verificarsi danni al Generatore.

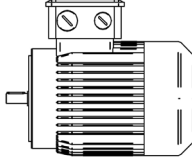
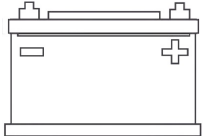
				
AC				DC
Fattore di potenza	1	0.8- 0.95	0.4-0.75 (Efficienza 0,85)	
IkW	<=1 000W	<=800W	<=400W	Tensione nominale 12V

⚠ ATTENZIONE!

- La potenza di applicazione indica quando ogni dispositivo è usato da solo.

ESEMPIO:

Potenza nominale in uscita del Generatore		1.000 w
Frequenza	Fattore di potenza	
AC	1,0	<= 1.000W
	0,8	<= 800W
DC	---	700W(12Vx58.3A)

⚠ ATTENZIONE!

La spia di sovraccarico ② si accende quando la potenza totale supera i dati di targa (vedi cap. 10).



⚠ ATTENZIONE!

- Non sovraccaricare, il carico totale di tutti gli apparecchi elettrici collegati non deve superare i dati di targa del Generatore. Un sovraccarico danneggia il Generatore.
- Quando si alimentano apparecchiature di precisione, controller elettronici, PC, computer elettronici, apparecchiature basate su microcomputer o caricabatterie, tenere il Generatore ad una distanza sufficiente per evitare interferenze elettriche. Assicurarsi inoltre che le frequenze emesse dal Generatore non interferiscano con altri dispositivi elettrici ed elettronici situati nelle vicinanze dello stesso.
- Se il Generatore deve alimentare apparecchiature mediche, è necessario prima consultare il produttore o un professionista del settore medico.
- Alcuni apparecchi elettrici o motori elettrici generici hanno correnti di avviamento elevate e non possono quindi essere utilizzati, anche se rientrano negli intervalli di alimentazione indicati nella tabella precedente. Consultare il produttore dell'apparecchiatura per ulteriori consigli.

7 MANUTENZIONE

ATTENZIONE!

- Prima di effettuare qualsiasi operazione di manutenzione ordinaria, arrestare il Generatore.
- Tutte le operazioni di manutenzione non contemplate nel presente manuale devono essere eseguite nei centri di assistenza autorizzati.



Le operazioni di manutenzione ordinaria possono essere eseguite dagli operatori.

ATTENZIONE!

- Il motore deve essere sottoposto a una manutenzione adeguata a garantire un funzionamento sicuro, economico e senza problemi, oltre che ecologico.
Per mantenere il motore a benzina in buone condizioni di funzionamento, deve essere sottoposto a manutenzione periodica. È necessario seguire attentamente il seguente programma di manutenzione e le procedure di ispezione di routine:

Componente	Frequenza	Ogni volta	Primo mese o prime 20 ore di funzionamento	In seguito, ogni 3 mesi o ogni 50 ore di funzionamento	Ogni anno o ogni 100 ore di funzionamento
Olio motore	Controllo - Ricarica	✓			
	Sostituzione		✓	✓	
Filtro aria	Controllo	✓			
	Pulizia		✓		
	Sostituzione			✓	
Candela di accensione	Controllo-regolazione				✓
	Sostituzione	Ogni anno o 250 ore di funzionamento			
Parascintille	Pulizia				
Funzionamento al minimo (se in dotazione) *	Controllo-regolazione				✓
Serbatoio e filtro carburante *	Pulizia				✓
Tubo del carburante	Controllo	Ogni 2 anni (cambiare se necessario)			

* Questi componenti devono essere mantenuti e riparati dal nostro rivenditore autorizzato.

ATTENZIONE!

Arrestare il motore prima di procedere alla manutenzione. Mettere il motore su una superficie piana e rimuovere il cappuccio della candela per impedire l'avviamento del motore.
Non azionare il motore in un ambiente poco ventilato o in un'altra zona chiusa. Assicursi di mantenere una buona ventilazione nell'area di lavoro. Lo scarico del motore può contenere CO velenoso, l'inalazione può causare shock, perdita di coscienza e persino la morte

ATTENZIONE!

- Se il motore a benzina funziona spesso a temperature elevate o con carichi pesanti, cambiare l'olio ogni 25 ore.
- Se il motore funziona frequentemente in condizioni di polvere o in altre circostanze gravi, pulire l'elemento filtrante dell'aria ogni 10 ore. Se necessario, sostituire l'elemento filtrante dell'aria ogni 25 ore.
- Rispettare i periodi di manutenzione indicati.
- Se la scadenza prevista per la manutenzione del motore non è stata rispettata, provvedere prima possibile.



OFFICINA AUTORIZZATA

È l'officina indicata dai nostri rivenditori, autorizzata ad eseguire operazioni di riparazione dei prodotti.

7.1 Ispezione candela



ATTENZIONE!

La candela è un componente importante del motore e dev'essere controllata periodicamente.

1. Rimuovere il coperchio ①, rimuovere il tappo della candela ②; utilizzando la chiave in dotazione al Generatore, svitare la candela ruotando in senso antiorario.
2. Controllare che non vi siano dei residui carboniosi, eventualmente rimuoverli con l'ausilio di una spazzola d'acciaio.
3. Verificare che la candela corrisponda al modello indicato: candela standard **A5RTC**

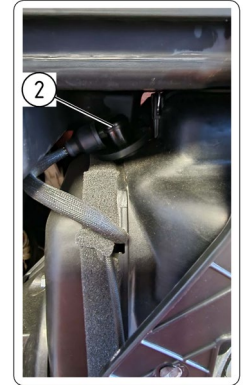

4. Con l'ausilio di uno spessimetro, verificare la distanza tra gli elettrodi: 0,6-0,8 mm.
5. Rimontare la candela con una coppia di serraggio di 12,5 Nm
6. Rimontare il tappo della candela ② ed il coperchio ①.

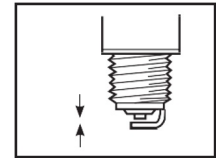

7.2 Regolazione carburatore



ATTENZIONE!

Il carburatore è un componente importante del motore, la sua manutenzione e regolazione dev'essere effettuata da un centro assistenza autorizzato.

7.3 Sostituzione olio motore



ATTENZIONE!

- Evitare di scaricare l'olio motore subito dopo l'arresto del motore. L'olio è caldo e dev'essere maneggiato con cura per evitare ustioni.
- Per la sostituzione dell'olio fare riferimento al Paragrafo 5.3.



ATTENZIONE!

Non inclinare il generatore quando si aggiunge olio motore. Ciò potrebbe causare un riempimento eccessivo e danni al motore.

7.4 Filtro dell'aria

- Posizionare il Generatore su una superficie piana.
- Rimuovere la vite ①, quindi rimuovere il coperchio ②.
- Rimuovere il coperchio del filtro ③.
- Rimuovere il filtro ③.
- Lavare l'elemento in spugna con detergente neutro e asciugarlo.
- Oliare l'elemento in spugna ed eliminare l'olio in eccesso. L'elemento in spugna deve essere inumidito ma non gocciolante.



ATTENZIONE!

Non strizzare l'elemento in spugna durante questa operazione. Potrebbe strapparsi.

- Inserire l'elemento in spugna nel corpo del filtro dell'aria, accertandosi che la superficie di tenuta dell'elemento in spugna faccia aderire il filtro dell'aria in modo che non vi siano perdite d'aria.



ATTENZIONE!

Il motore non deve mai funzionare senza l'elemento in spugna; ne può derivare un'eccessiva usura del pistone e del cilindro.

- Rimontare il coperchio del corpo del filtro ③ dell'aria nella sua posizione originale.
- Rimontare il coperchio ② e stringere la vite ①.

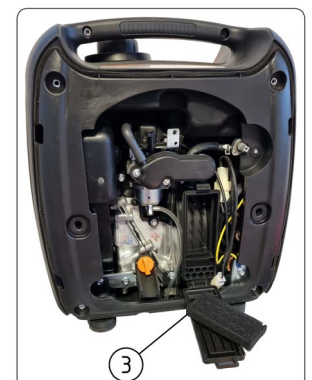
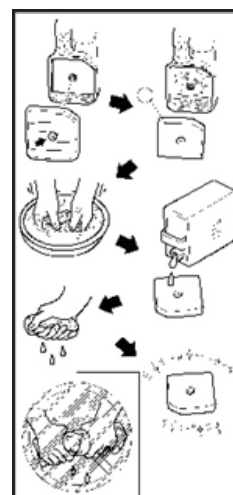

7.5 Schermo del silenziatore e parascintille

ATTENZIONE!

Il motore e il silenziatore saranno molto caldi dopo il funzionamento del motore. Evitare di toccare il motore e il silenziatore quando sono ancora caldi con qualsiasi parte del corpo o con gli indumenti durante l'ispezione o la riparazione.

- Rimuovere le viti ①, estrarre il coperchio ②.
- Allentare il bullone ③, rimuovere la fascetta metallica del silenziatore ④.
- Rimuovere il cappuccio del silenziatore ⑤.
- Pulire eventuali depositi di carbonio presenti sul silenziatore con una spazzola metallica.

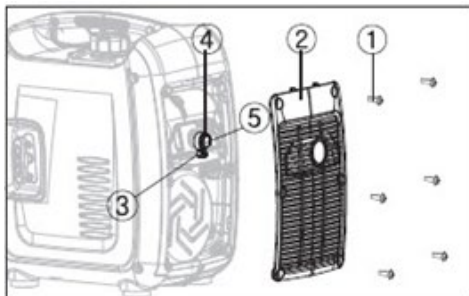

ATTENZIONE!

Durante la pulizia, utilizzare delicatamente la spazzola metallica per evitare di danneggiare il silenziatore.

- Se il silenziatore risulta danneggiato, sostituirlo.
- Rimontare il silenziatore ⑤, la fascetta metallica ④, il coperchio ② e le viti ①.

7.6 Filtro serbatoio carburante

ATTENZIONE!

Non utilizzare mai la benzina quando si fuma o in prossimità di una fiamma libera.

- Rimuovere il tappo del serbatoio carburante e il filtro.
- Pulire il filtro con benzina e rimontarlo.
- Chiudere nuovamente il tappo del serbatoio carburante.

ATTENZIONE!

Assicurarsi che il tappo del serbatoio carburante sia ben stretto.

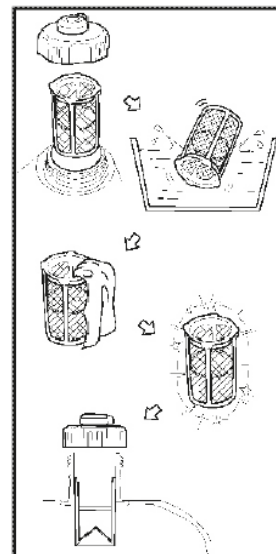

8 CONSERVAZIONE

AVVISO!

Se la macchina viene messa a riposo per un periodo prolungato saranno necessarie alcune procedure preventive per proteggerla dal deterioramento.

8.1 Scarico del carburante

- Ruotare il rubinetto del carburante in posizione "0" **CLOSE**.
- Rimuovere il tappo del serbatoio carburante e il filtro. Estrarre il carburante dal serbatoio versandolo in un contenitore di benzina omologato. Quindi, rimontare il tappo del serbatoio carburante.



ATTENZIONE!

Il carburante è altamente infiammabile e velenoso, pulire immediatamente il carburante versato con un panno morbido, pulito e asciutto, poiché il carburante potrebbe deteriorare le superfici verniciate o le parti in plastica

AVVISO!

Avviare il motore e lasciarlo girare finché non esaurisce il carburante residuo, non collegare dispositivi elettrici, operazione da fare a vuoto. La durata del funzionamento a vuoto dipende dal carburante residuo nel serbatoio.

AVVISO!

Pulire l'esterno del Generatore, conservare in un luogo asciutto, ben ventilato e protetto.

9 RISOLUZIONE DEI PROBLEMI

ATTENZIONE!

Tutte le manutenzioni straordinarie devono essere eseguite da un manutentore meccanico.

INCONVENIENTE	CAUSA	RIMEDIO
Il motore non si avvia.	- Carburante assente nel serbatoio. - Carburante presente nel serbatoio.	- Riempire il serbatoio carburante. - Verificare la posizione della valvola di sfiato sul tappo del serbatoio (vedi par. 4.9) Verificare la posizione del rubinetto carburante (vedi par. 4.1).
	Carburatore intasato.	Portare il Generatore in un Centro Assistenza Autorizzato dal Costruttore.
Livello olio motore basso (si accende la spia)	Olio mancante.	Rabboccare l'olio sul motore (vedi par. 5.2).
Malfunzionamento elettrico/meccanico.	- Candela sporca o bagnata. - Sistema di accensione difettoso.	- Ripulire e asciugare la candela (vedi par. 7.1). - Portare il Generatore in un Centro Assistenza Autorizzato dal Costruttore.
Il Generatore non produce energia.	- Dispositivo di sicurezza (protezione DC) su "OFF".	- Portare la protezione DC su "ON".
	- La spia pilota AC (verde) si spegne.	- Spegnerne il motore, poi riavviarlo.

10 SPECIFICHE TECNICHE

Modello		1kW
Generatore	Tipo	Inverter silenziato
	Frequenza nominale (Hz)	50/60
	Tensione nominale (V)	110/120/220/230/240
	Potenza di uscita nominale (kW)	1,0
	Fattore di potenza	1
	Capacità serbatoio carburante (L)	2,5
	Qualità dell'uscita CA	ISO8528 G2
	Tensione di carica (DC) (V)	12
	Corrente di carica (DC) (A)	58.3
	Potenza (DC) (W)	700
	Protezione da sovraccarico (DC)	Protezione senza fusibili
Motore	Motore	R60-i
	Tipo di motore	Monocilindrico, 4 tempi, raffreddamento ad aria forzata, OHV
	Cilindrata (cc)	60
	Tipo di carburante	Benzina senza piombo
	Tempo di funzionamento continuo (alla potenza nominale) (h)	4
	Capacità d'olio (L)	0,31
	N. modello candela	ASRTC
	Modalità di avviamento	Avviamento autoavvolgente
Generatore	Lunghezza x larghezza x altezza (mm)	380×240×420
	Peso netto (kg)	13

11 DEMOLIZIONE E SMALTIMENTO DEI COMPONENTI

11.1 Smaltimento materiali esausti

La macchina, successivamente all'installazione e nel suo normale funzionamento, non comporta contaminazione ambientale, ma durante l'intero periodo di utilizzo vengono comunque prodotti alcuni tipi di materiali di scarto od esausti in particolari condizioni (ad esempio il grasso di lubrificazione delle parti meccaniche).

Per lo smaltimento di questi materiali esistono in ogni nazione normative specifiche per la salvaguardia dell'ambiente. È obbligo del Cliente essere a conoscenza delle leggi vigenti in merito nel proprio Paese ed operare in modo da ottemperare a tali legislazioni in conformità alle indicazioni riportate sulle schede tecniche dei prodotti utilizzati, richiedibili al Costruttore.



ATTENZIONE!

Si rammenta l'osservanza delle leggi vigenti in materia di smaltimento degli oli minerali o dei grassi utilizzati per la lubrificazione/manutenzione.



ATTENZIONE!

Maggiori informazioni sulle modalità di smaltimento di oli ed altre sostanze possono essere reperite nella scheda di sicurezza delle sostanze stesse.

Lo smaltimento dei rifiuti tossici nelle fasi di raccolta, trasporto, trattamento (inteso come operazione di trasformazione necessaria per il recupero), nonché il deposito e la discarica sul suolo costituiscono attività di pubblico interesse sottoposte all'osservanza dei seguenti principi generali:

- a) Deve essere evitato ogni danno o pericolo per la salute, l'incolumità e la sicurezza della collettività e dei singoli.
- b) Deve essere garantito il rispetto delle esigenze igienico-sanitarie ed evitato ogni rischio di inquinamento dell'aria, dell'acqua, del suolo e del sottosuolo.

Devono essere promossi, con l'osservanza di criteri economici ed efficienti, i sistemi di recupero e riciclaggio di materiali ed energia.

11.2 Indicazioni per rifiuti speciali

Sono rifiuti speciali i residui derivanti da lavorazioni industriali ed i materiali provenienti da demolizioni di apparecchiature e macchinari deteriorati ed obsoleti.

Allo smaltimento dei rifiuti speciali, anche tossici e nocivi, sono tenuti a provvedere i produttori dei rifiuti stessi, direttamente o attraverso imprese od enti autorizzati, o consegnandoli ai soggetti che gestiscono il servizio pubblico, con i quali sia stata stipulata apposita convenzione.

Ciascun Paese/Comune è tenuto a fornire alla Regione tutte le informazioni disponibili sullo smaltimento dei rifiuti nel proprio territorio.



ATTENZIONE!

Lo smaltimento abusivo del prodotto da parte del detentore comporta l'applicazione delle sanzioni amministrative previste dalle normative vigenti.



ATTENZIONE!

Ai sensi della Direttiva "RAEE" 2012/19/UE se il componente/prodotto acquistato è contrassegnato con il seguente simbolo del contenitore di spazzatura su ruote barrato, significa che il prodotto alla fine della propria vita utile deve essere raccolto separatamente dagli altri rifiuti.

La raccolta differenziata del presente componente/prodotto giunto a fine vita è organizzata e gestita dal Costruttore. L'utente che vorrà disfarsi della presente apparecchiatura dovrà quindi contattare il produttore e seguire il sistema che questo ha adottato per consentire la raccolta separata dell'apparecchiatura giunta a fine vita. L'adeguata raccolta differenziata per l'avvio successivo dell'apparecchiatura dimessa al riciclaggio, al trattamento e allo smaltimento ambientale compatibile contribuisce ad evitare possibili effetti negativi sull'ambiente e sulla salute e favorisce il reimpiego e/o riciclo dei materiali di cui è composta l'apparecchiatura. Lo smaltimento abusivo del prodotto da parte dell'utente comporta l'applicazione delle sanzioni previste dalle Leggi localmente in vigore.



Thank you for choosing a silent inverter gasoline engine generator set of our company.

This manual contains the information on how to do that. Please read it carefully before operating. Operating safely and correctly can help you get the best results.

All information in this publication is based on the latest product information available at the time of printing. The contents in this manual may be different from the actual parts due to revision and other changes.

Our company reserves the right to make changes at any time without notice and without incurring any obligation. No part of this publication may be reproduced without our company's written permission.

This manual should be considered a permanent part of the generator and should accompany the generator if it is resold.

SAFETY WARNINGS

WARNING!

Personal safety and property safety of you and others are very important. Please read these messages carefully which is preceded the symbol.

DANGER !

You WILL be KILLED or SERIOUSLY HURT if you don't follow instructions.

WARNING !

You WILL be KILLED or SERIOUSLY HURT if you don't follow instructions.

ATTENTION!

You CAN be HURT if you don't follow instructions.

WARNING !

Your generator or other property could be damaged if you don't follow instructions.

CONTENTS

SAFETY WARNINGS	23
1 SAFETY INFORMATION	25
2 LOCATION OF IMPORTANT LABELS	27
3 DESCRIPTION	28
3.1 Control panel.....	28
4 CONTROL FUNCTION	29
4.1 Fuel valve.....	29
4.2 Choke lever.....	29
4.3 Oil warning light (red).....	29
4.4 Overload indicator light (red).....	30
4.5 AC pilot light (green).....	30
4.6 DC protector.....	30
4.7 Generator switch.....	30
4.8 Smart Switch (C).....	31
4.9 Fuel tank cap.....	31
4.10 Fuel tank cap air vent knob.....	31
4.11 Ground (Earth) terminal.....	31
5 PREPARATION	32
5.1 Fuel.....	32
5.2 Fuel refueling.....	32
5.3 Engine oil.....	32
5.4 PRE-OPERATION CHECK.....	33
6 OPERATION	33
6.1 Starting the engine.....	33
6.2 Stopping the engine.....	34
6.3 Alternating Current (AC) connection.....	34
6.4 Application range.....	35
7 MAINTENANCE	36
7.1 Spark plug inspection.....	37
7.2 Carburetor adjustment.....	37
7.3 Engine oil replacement.....	37
7.4 Air filter.....	37
7.5 Muffler screen and spark arrester.....	38
7.6 Fuel tank filter.....	38
8 STORAGE	39
8.1 Drain the fuel.....	39
9 TROUBLESHOOTING	39
10 SPECIFICATIONS	40
11 DISMANTLING THE MACHINE WHEN NO LONGER USED	40
11.1 Disposal of exhaust materials.....	40
11.2 Indications for special waste.....	41

1 SAFETY INFORMATION

Read and understand this owner's manual before operating your generator. It will help you avoid accidents if you get familiar with your generator's safe operation procedures.

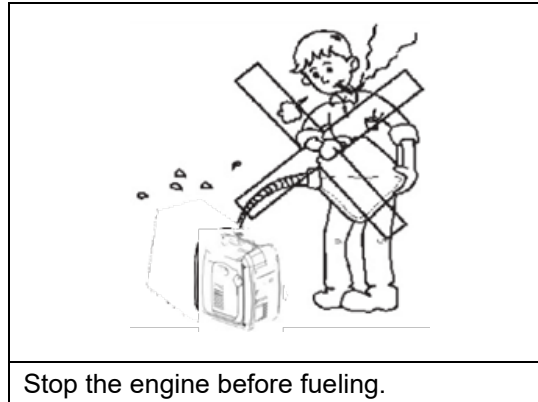
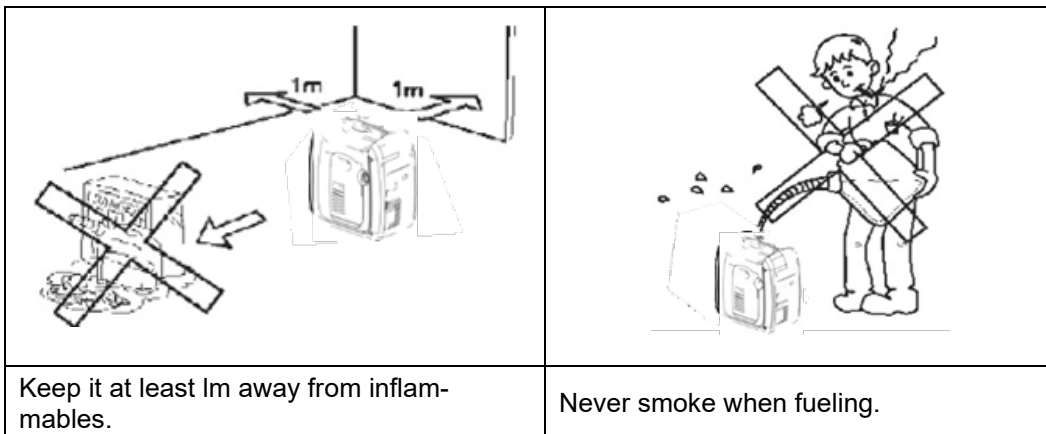
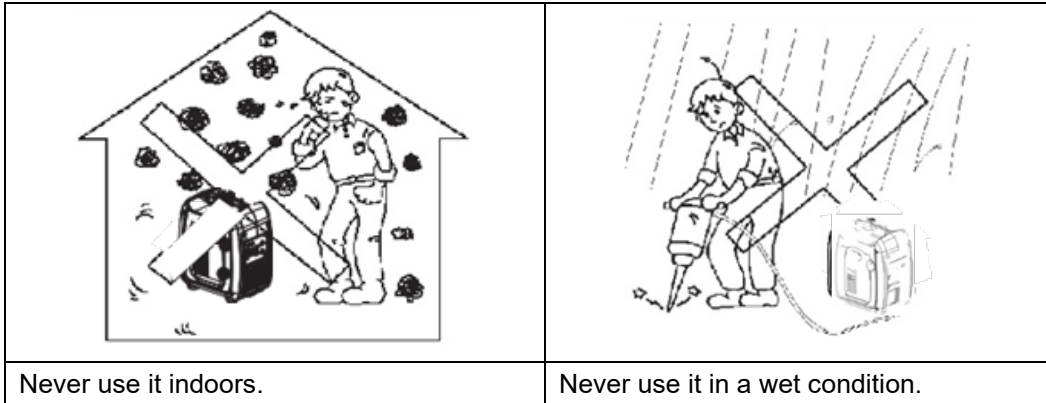

WARNING!

Connections to a Home Power Supply.

If the generator is to be connected to a home power supply as a standby, connection shall be performed by a professional electrician or by another person with proficient electrical skill.

When the loads are connected to the generator, please carefully check whether electrical connections are safe and reliable. Any improper connection may cause damage to the generator, or cause a fire.

DANGER!

The Generator is **NOT** a battery charger and cannot be used as such as it is not equipped with any control and protection system for the current supplied.

Use as a battery charger **IS NOT PERMITTED AND PROHIBITED BY THE MANUFACTURER.** It is dangerous and can damage the battery and the generator. In case of fire it can cause serious injuries.

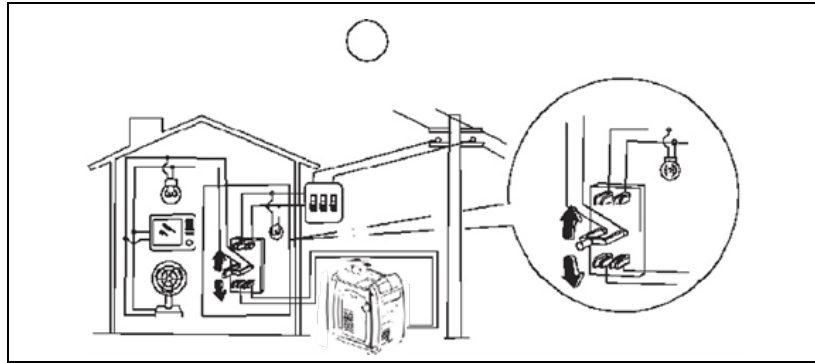
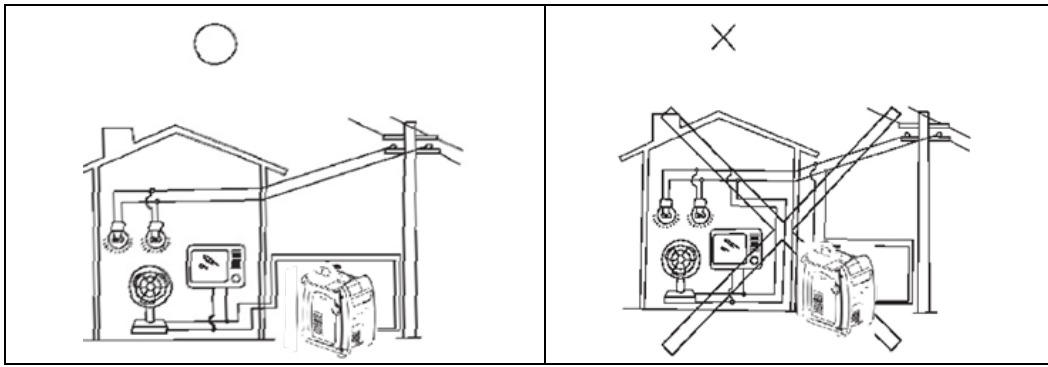

Generator Ground Circuit

In order to prevent electric shock due to shoddy electrical appliances or wrong use of electricity, the generator must be grounded with a good-quality insulated conductor.

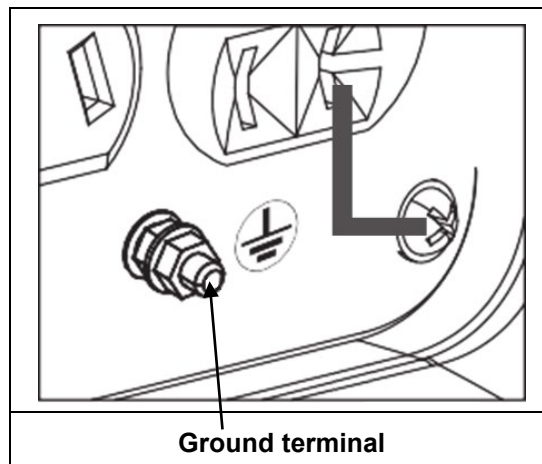

WARNING!

Make sure the control panel, louver and the inverter bottom side cooling well and without chips, mud and water come in. It may damage the engine, inverter or alternator if the cooling vent blocked.

Do not mix the generator with other stuff if moving, storing or running the unit. It may cause the generator damage or bring property safety issue when the generator in leakage.



2 LOCATION OF IMPORTANT LABELS

WARNING!

Please read the following labels carefully before operation this machine.

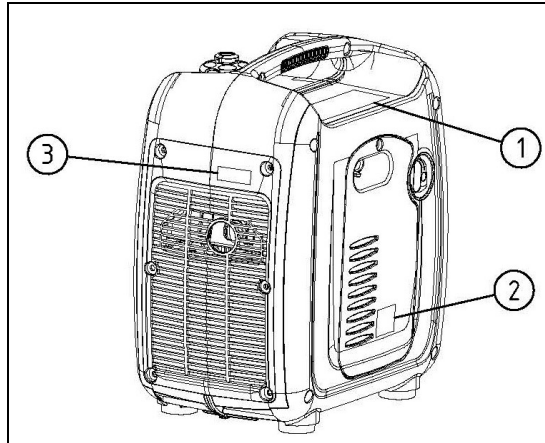
TIP: Maintain or replace safety and instruction labels, as necessary.



 WARNING	
1	<ul style="list-style-type: none">● Read the owner's manual and all labels before operating.● Only operate in well-ventilated areas. Exhaust gas contains poisonous carbon monoxide.● Check for spilled fuel or fuel leaks.● Stop engine before refueling.● Do not operate near flammable materials.● Electrocutation can occur if generator is used in rain, snow, or near water. Keep this unit dry at all times.● Electrocutation or property damage can occur. Do not connect this generator to any building's electrical system unless an isolation switch has been installed by a licensed electrician. Refer to the owner's manual.● When operating the generator:<ul style="list-style-type: none">Never place a partition or other barrier around the generator.Do not cover the generator with a box.Do not place any objects on the generator.● Turn the fuel tank cap air vent knob to "OFF" after the engine has completely cooled down.
2	
3	

3 DESCRIPTION

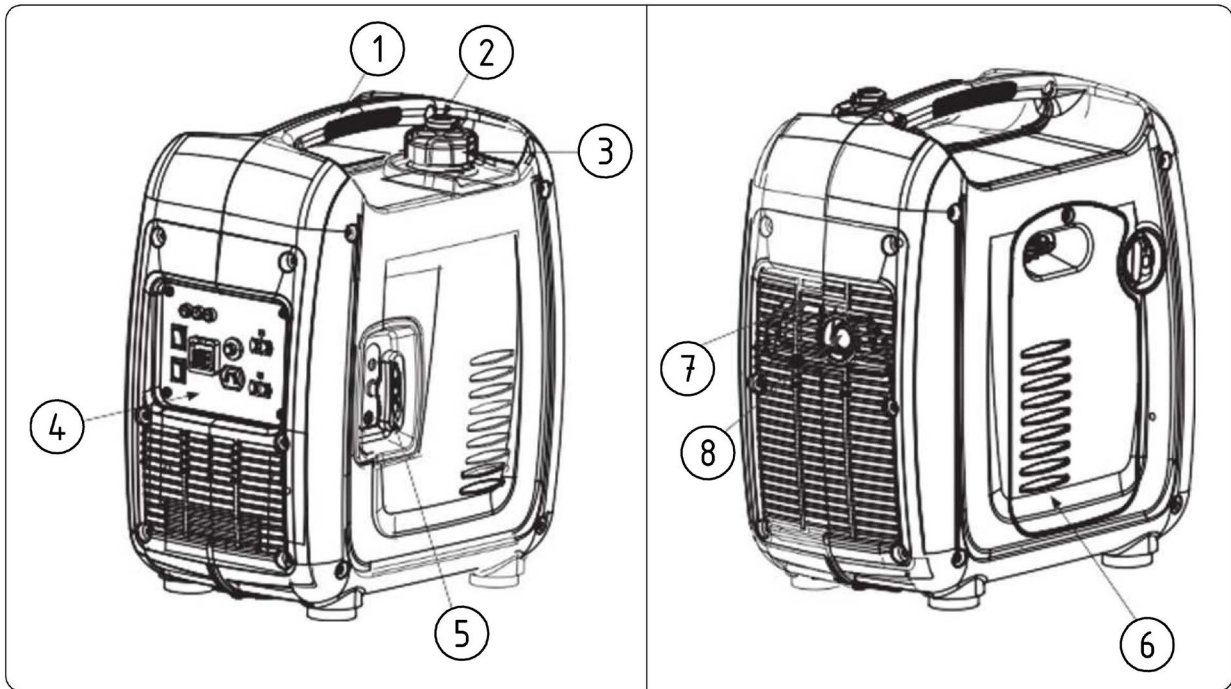

Pos.	Denomination
1	Carrying handle
2	Fuel tank cap air vent knob
3	Fuel tank cap
4	Control panel
5	Recoil starter
6	Oil filler cap
7	Louver
8	Muffler

3.1 Control panel

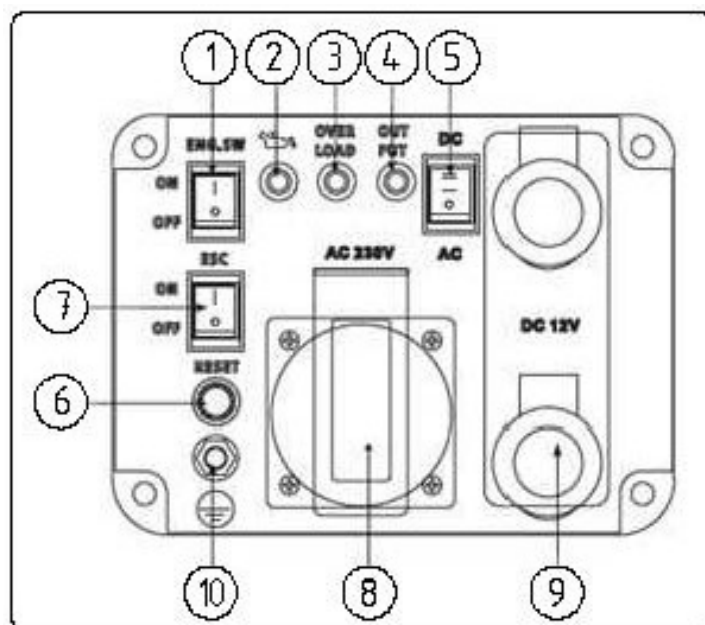

Pos.	Denomination
1	Generator switch
2	Oil warning light
3	Overload indicator light
4	AC pilot light
5	AC/DC switch
6	AC Reset
7	ESC (Engine Smart Control)
8	AC receptacle
9	Binding posts (+/-) DC
10	Ground (earth) terminal

4 CONTROL FUNCTION

4.1 Fuel valve

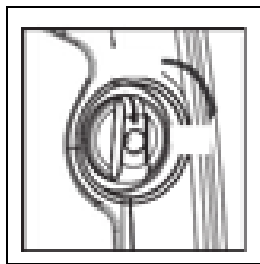

The fuel valve controls fuel flowing from the fuel tank to carburetor. Be sure to return the lever to “OFF” after stopping the engine.

4.2 Choke lever

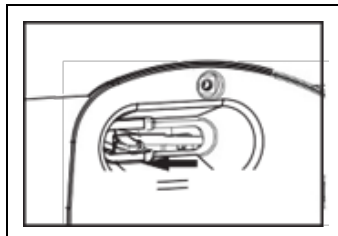

The choke lever is used to provide an enriched fuel mixture when starting a cold engine. Slowly put the choke lever to “OPEN” position after the engine is started.

TIP: The choke is not required to start a warm engine.

4.3 Oil warning light (red)



When the oil level falls below the lower level, the oil warning light ① comes on and then the engine stops automatically. Unless you refill with oil, the engine will not start again.

TIP: If the engine stalls or does not start, turn the engine switch to „ON“ and pull the recoil starter. If the oil warning light flickers for a few seconds, the engine oil is insufficient. Add oil and restart.

4.4 Overload indicator light (red)

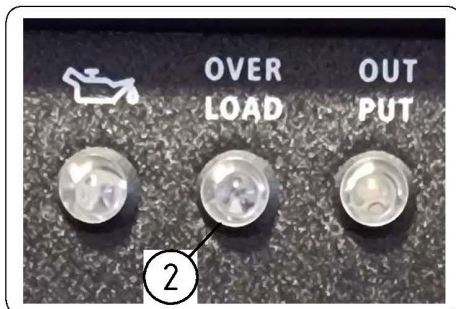

The overload indicator light ② comes on when an overload of a connected electrical device is detected, the inverter control unit overheats, or the AC output voltage rises. Then, the AC protector will trip, stopping power generation in order to protect the generator and any connected electric devices. The AC pilot light (Green) will go off and the overload indicator light (Red) will stay on, but the engine will not stop running.

When the overload indicator light comes on and power generation stops, proceed as follows:

1. Turn off any connected electric devices and stop the engine.
2. Reduce the total wattage of connected electric devices within the rated output.
3. Check for blockages in the cooling air inlet and around the control unit. If any blockages are found, remove.
4. After checking, restart the engine.

TIP: The overload indicator light may come on for a few seconds at first when using electric devices that require a large starting current, such as a compressor or a submersible pump. However, this is not a malfunction.

4.5 AC pilot light (green)

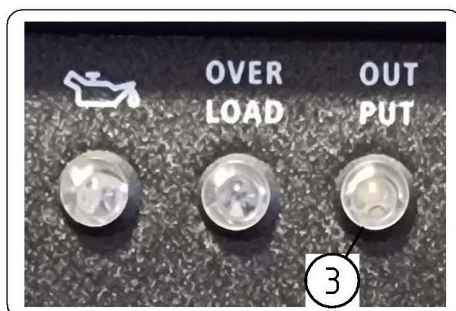

The AC pilot light ③ comes on when the engine starts and produces power.

4.6 DC protector

4.7 Generator switch

① - **On:** Start the Generator

② - **Off:** Stop the Generator

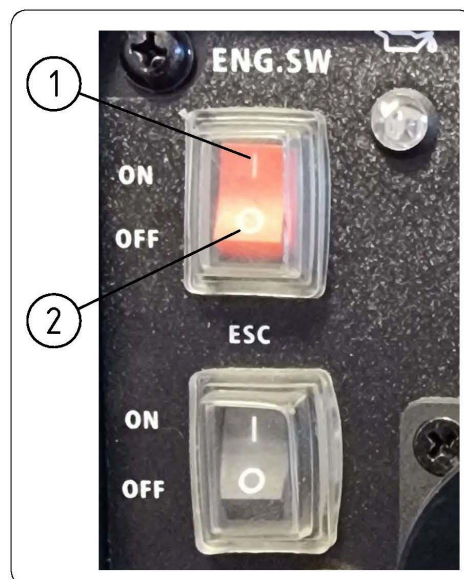

4.8 Smart Switch (C)

The smart function, if enabled (switch in 1 "ON" position) allows the engine to idle with reduced fuel consumption, in conditions of load absence or light load. When the load increases, the engine rpm also increase to provide more power.

When the smart function is disabled (switch in 0 "OFF" position), the engine is always at its maximum speed to immediately provide maximum power. This function is useful when electric tools with high starting absorption must be started.



4.9 Fuel tank cap

Remove the fuel tank cap by turning it counterclockwise.

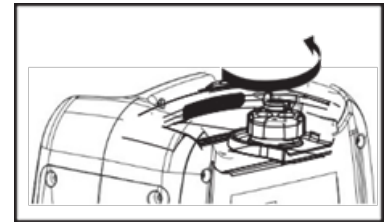

4.10 Fuel tank cap air vent knob

The fuel tank cap (2) is equipped with an air vent knob to (1) stop the flow of fuel.

The air vent knob must be turned to "ON". This will allow fuel to flow to the carburetor and the engine to run.

When the engine is not in use, turn the air vent knob to "OFF" to stop fuel flow.

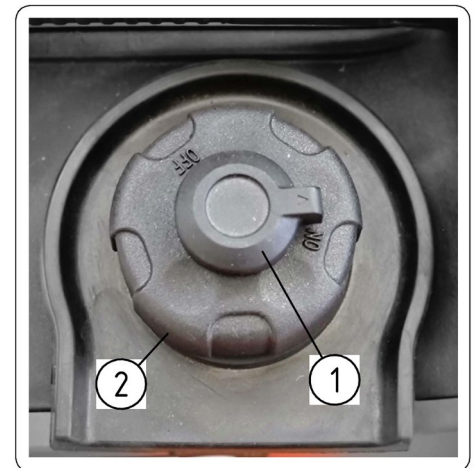

4.11 Ground (Earth) terminal

Ground (Earth) terminal (1)



WARNING!
To be connected only if you are using the generator connected to the 220 V alternating current network.



5 PREPARATION

5.1 Fuel



WARNING!

Fuel is highly flammable and poisonous. Check "SAFETY INFORMATION" carefully before filling.

- Do not overfill the fuel tank, otherwise it may overflow when the fuel warms up and expands.
- After fill the fuel, make sure the fuel tank cap is tightened securely.



WARNING!

- Immediately wipe off spilled fuel with a clean, dry, soft cloth, since fuel may deteriorate painted surfaces or plastic parts.
- Use only unleaded gasoline. The use of leaded gasoline will cause severe damage to internal engine parts.

5.2 Fuel refueling



WARNING!

Fuel is highly flammable and poisonous. Check "SAFETY INFORMATION" carefully before filling.

- Do not overfill the fuel tank, otherwise it may overflow when the fuel warms up and expands.
- After fill the fuel, make sure the fuel tank cap is tightened securely.



WARNING!

- Immediately wipe off spilled fuel with a clean, dry, soft cloth, since fuel may deteriorate painted surfaces or plastic parts.
- Use only unleaded gasoline. The use of leaded gasoline will cause severe damage to internal engine parts.



WARNING!

To refuel, remove the fuel tank cap and fill the tank to the red level ①.

Recommended fuel:

Unleaded petrol

Fuel tank capacity:

Total: 2.5L

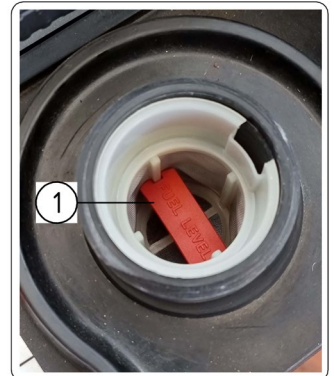

5.3 Engine oil



WARNING!

The generator has been shipped without engine oil. Do not start the engine till fill with the sufficient engine oil.



- Place the Generator on a flat surface.
- Remove the screws ①, and then remove the cover ②.
- Remove the oil filler cap ③.
- Filling the specified amount of the recommended engine oil, and then install and tighten the oil filler cap ③.
- Install the cover ② and tighten the screws ①.

Recommended engine oil:	SAE SJ 15W-40
Recommended engine oil grade:	API Service SE type or higher
Engine oil quantity:	0.31 L

5.4 PRE-OPERATION CHECK

WARNING!

- If any item in the Pre-operation check is not working properly, have it inspected and repaired before operating the generator. The condition of a generator is the owner 's responsibility. Vita! components can start to deteriorate quickly and unexpectedly, even if the generator unused.
- Verification of the condition of Generator is the responsibility of the owner.
- Pre-use checks must be made each time the Generator is used.
- Before use, check the **fuel** level (see par. 5.2), top up if necessary.
- Before use, check the engine **oil level** (see par. 5.3), top up if necessary.
- Before use, check that the generator does not have oil leaks.

In case of anomalies not described in this manual, contact an authorized workshop.

6 OPERATION

WARNING!



Never operate the engine in a closed area or it may cause unconsciousness and death within a short time. Operate the engine in a well ventilated area.

- Before starting the engine, do not connect any electric devices.
- The generator has been shipped without engine oil. Do not start the engine till fill with the sufficient engine oil (see par. 5.3).
- Do not tilt the generator when adding engine oil. This could result in overfilling and damage to the engine.
- The generator can be used with the rated output load at standard atmospheric conditions:
 - Ambient temperature: 25°C
 - Barometrie pressure: 100kPa
 - Relative humidity: 30%.
- The output of the generator varies due to change temperature, altitude (lower air pressure at higher altitude) and humidity.
- The output of the generator is reduced when the temperature, the humidity and the altitude are higher than standard atmospheric conditions.
- Additionally, the load must be reduced when using in a confined areas, as generator cooling is affected.

6.1 Starting the engine

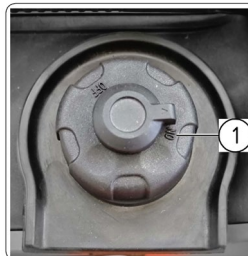
- 1- Turn the air vent knob to "ON"  ;



- 2- Turn the fuel cock  to position **A**;
- 3- Move the choke lever  to position **B**;

The Generator is ready to be started.



! WARNING!

The choke is not required to start a warm engine. Push the choke knob in to the position “OPEN”.

- 4- Slowly pull the recoil starter handle ② until it engages, then pull it quickly to start the engine.



! WARNING!

Grasp the carrying handle ① firmly to prevent the generator from falling over when pulling the recoil starter.

- 5- After the engine starts, warm up the engine until the engine does not stop when the choke lever is turned to the “OPEN” position.

6.2 Stopping the engine

! WARNING!

- Before stopping the Generator engine, turn off all connected electrical devices.
- Turn the generator switch to the "OFF" position (see par. 4.7).
- Turn the fuel tap to the "0" CLOSE position.

The ignition circuit is off, the fuel is closed.



- After the engine has completely cooled down, turn the air vent knob to "OFF" - 1.



6.3 Alternating Current (AC) connection

! WARNING!

- Make sure all electrical devices are turned off before connecting them to the Generator.
- Be sure all electric devices including the lines and plug connections are in good condition before connection to the generator.
- Be sure the total load is within generator rated output.
- Be sure the receptacle load current is within receptacle rated current.

NOTE: if the Generator is connected to the 220 V AC mains, the Generator must also be connected to earth via the Earth terminal (see par. 4.11).

! WARNING!

When using 12 V tools, the "ESC" intelligent switch (see par. 4.8) must be in position 1 "ON").

6.4 Application range

! WARNING!

When using the generator, make sure the total load is within rated output of a generator. Otherwise, generator damage may occur.

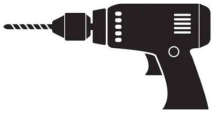
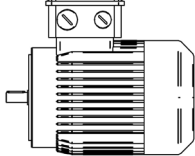
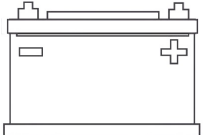
AC				DC 
Power factor	1	0.8- 0.95	0.4-0.75 (Efficiency 0,85)	
IkW	<=1 000W	<=800W	<=400W	Rated voltage 12V

! WARNING!

- Application power indicates when each device is used alone.

EXAMPLE:

Generator rated output		1.000 w
Frequency	Power factor	
AC	1,0	<= 1.000W
	0,8	<= 800W
DC	---	700W(12Vx58.3A)

! WARNING!

The overload indicator light ② it lights up when the total power exceeds the data on the plate (see chap. 10).



! WARNING!

- Do not overload. The total load of all electrical appliances appliance must not exceed the supply range of the generator. Overloading will damage the generator.
- When supplying precision equipment, electronic controllers, PCs, Electronic computers, microcomputer based equipment or battery chargers, keep the generator a sufficient distance away to prevent electrical interference from the engine. Also ensure that electrical noise form the engine does not interfere with any other electrical devices located near the generator.
- If the generator is to supply medical equipment, advice should first be obtained from the manufacturer, a medical professional or hospital.
- Some electrical appliances or general-purpose electric motors have High starting currents, and cannot therefore be used, even if they lie within the supply ranges given in the above table. Consult the equipment manufacturer for further advice.

7 MAINTENANCE

WARNING!

- Before carrying out any routine maintenance operation, stop the Generator.
- All maintenance operations not covered by this manual must be carried out in authorized service centers.



Ordinary maintenance operations can be performed by operators.

WARNING!

- The engine must be properly maintained to ensure its operation be safe, economy and trouble-free, as well as eco-friendly.
In order to keep your gasoline engine in good working condition, it must be periodically serviced. The following maintenance schedule and routine inspection procedures must be carefully followed:

Items	Frequency	Frequency			
		Each time	First 1 month or first 20 hrs of operation	Thereafter, every 3 months or every 50 hrs of operation	Every year or every 100 hrs of operation
Engine oil	Check-Refill	✓			
	Replace		✓	✓	
Air filter element	Check	✓			
	Clean		✓		
	Replace			✓	
Spark Plug	Check-adjust				✓
	Replace	Every year or 250 hrs of operation			
Spark arrester	Clean				
Idling (if equipped)*	Check-adjust				✓
Fuel tank & fuel filter *	Clean				✓
Fuel line	Check	Every 2 years (change if necessary)			

* These items should be maintained and repaired by our authorized dealer, unless the owner has appropriate tools and is proficient with mechanical maintenance.

WARNING!

Stop the engine before servicing. Put the engine on a level surface and remove the spark plug cap to prevent the engine from starting.

Do not operate the engine in a poorly ventilated room or other enclosed area. Be sure to keep good ventilation in working area. The exhaust from the engine may contain poisonous CO, inhalation can cause shock, unconsciousness and even death.

WARNING!

- If the petrol engine often runs at high temperatures or with heavy loads, change the oil every 25 hours.
- If the engine frequently work under dusty or other severe circumstances, clean the air filter element every 100 hours; If necessary, change the air filter element every 25 hours.
- Respect the maintenance periods indicated.
- If the due date for engine maintenance has not been met, take action as soon as possible.



AUTHORISED SERVICE POINTS

These are the centres authorised by the Manufacturer to repair the products.

7.1 Spark plug inspection



WARNING!

The spark plug is important engine components, which should be checked periodically.

1. Remove the cover ①, remove the spark plug cap ②; using the wrench supplied with the generator, unscrew the spark plug by turning it anticlockwise.
2. Check that there are no carbon residues, if necessary, remove them with the aid of a steel brush.
3. Verify that the spark plug matches the model indicated: standard spark plug **A5RTC**

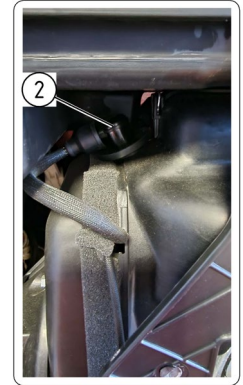

4. Using a thickness gauge, check the distance between the electrodes: 0.6-0.8 mm.
5. Refit the spark plug with a tightening torque of 12.5 Nm.
6. Refit the spark plug cap ② and cover ①.

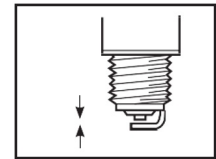

7.2 Carburetor adjustment



WARNING!

The carburetor is a vital part of the engine. Adjusting should be left to our company authorized dealer with the professional knowledge, specialized date, and equipment to do so properly.

7.3 Engine oil replacement



WARNING!

- Avoid draining the engine oil immediately after stopping the engine. The oil is hot and should be handled with care to avoid burns.
- To replace the oil, refer to Paragraph 5.3.



WARNING!

Do not tilt the generator when adding engine oil. This could result in overfilling and damage to the engine.

7.4 Air filter

- Place the Generator on a flat surface.
- Remove screw ①, then remove cover ②.
- Remove filter cover ③.
- Remove filter ③.
- Wash the sponge element with neutral detergent and dry it.
- Oil the sponge element and wipe off excess oil. The sponge element must be moistened but not dripping.

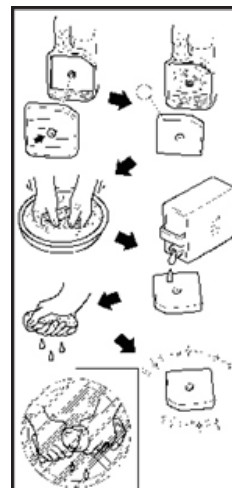

WARNING!

Do not wring the foam element during this operation. It could tear.

- Insert the sponge element into the air cleaner body, making sure the sealing surface of the sponge element adheres the air cleaner so that there is no air leakage.



WARNING!

The engine must never run without the sponge element; this can result in excessive wear of the piston and cylinder.

- Refit the air cleaner body cover ③ to its original position.
- Refit cover ② and tighten screw ①.

7.5 Muffler screen and spark arrester



WARNING!

The engine and muffler will be very hot after the engine has been run. Avoid touching the engine and muffler while they are still hot with any part of your body or clothing during inspection or repair.

- Remove screws ①, take off cover ②.
- Loosen bolt ③, remove silencer metal clamp ④.
- Remove muffler cap ⑤.
- Clean any carbon deposits on the silencer with a wire brush.

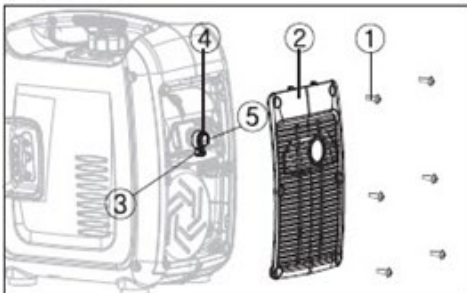

WARNING!

When cleaning, use the wire brush lightly to avoid damaging or scratching of muffler screen and spark arrester.

- If the silencer is damaged, replace it.
- Refit the silencer ⑤, the metal clamp ④, the cover ② and the screws ①.

7.6 Fuel tank filter



WARNING!

Never use the gasoline while smoking or in the vicinity of an open flame.

- Remove the fuel tank cap and filter.
- Clean the filter with petrol and refit it.
- Install the fuel tank cap.



WARNING!

Be sure the fuel tank cap is tightened securely.

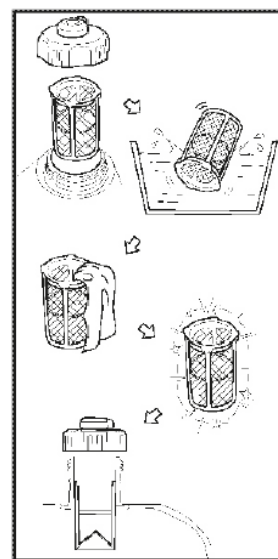

8 STORAGE

WARNING!

Long term storage of your machine will require some preventive procedures to guard against deterioration.

8.1 Drain the fuel

- Turn the fuel tap to the "0" **CLOSE** position.
- Remove the fuel tank cap, remove the filter . Extract the fuel from the fuel tank into an approved gasoline container. Then, install the fuel tank cap.

WARNING!

Fuel is highly flammable and poisonous, wipe off spilled fuel immediately with a soft, clean, dry cloth as fuel may deteriorate painted surfaces or plastic parts.



WARNING!

Start the engine and let it run until the residual fuel runs out, do not connect electrical devices, this operation must be done empty. The duration of idle operation depends on the remaining fuel in the tank.

WARNING!

Clean the outside of the Generator, store in a dry, well ventilated and protected place.

9 TROUBLESHOOTING

WARNING!

All extraordinary maintenance must be carried out by a mechanical maintenance technician.

FAULT	CAUSE	REMEDY
The engine does not start.	- No fuel in the tank. - Fuel present in the tank.	- Refill the fuel tank. - Check the position of the breather valve on the tank cap (see par. 4.9) Check the position of the fuel tap (see par. 4.1).
	Carburettor clogged.	Take the Generator to a Manufacturer's Authorized Service Center.
Low engine oil level (warning light comes on)	Missing oil.	Top up the oil on the engine (see par. 5.2).
Electrical / mechanical malfunction.	- Dirty or wet candle. - Defective ignition system.	- Clean and dry the spark plug (see par.7.1). - Take the Generator to a Manufacturer Authorized Service Center.
The Generator does not produce energy.	- Safety device (DC protection) to "OFF". - The AC pilot light (green) turns off.	- Set the DC protection to "ON". - Stop the engine, then restart it.

10 SPECIFICATIONS

Model		1kW
Generator	Type	Silent inverter
	Rated frequency (Hz)	50/60
	AC Rated voltage (V)	110/120/220/230/240
	AC Rated output power (kW)	1,0
	Power factor	1
	Fuel tank capacity (L)	2,5
	AC output quality	ISO8528 G2
	DC Output quality (V)	12
	DC Output Current (A)	58.3
	DC Output Power (W)	700
	Overload protect (DC)	Non-fuse-protector
Engine	Engine	R60-i
	Engine type	Single cylinder, 4-Stroke, forced air cooling, OHV
	engine capacity (cc)	60
	Fuel type	Unleaded gasoline
	Continue running time (at rated power) (h)	4
	Oil capacity (L)	0,31
	Spark model	ASRTC
	Starting mode	Recoil starter
Generator	Legth x Width x Heigth (mm)	380×240×420
	Net weighth (kg)	13

11 DISMANTLING THE MACHINE WHEN NO LONGER USED

11.1 Disposal of exhaust materials

After having been installed and during use, the machine does not cause any environmental pollution. However, throughout its working life, some types of residual waste or exhaust materials, such as the lubricants for the mechanical components, are being produced in certain maintenance situations.

There are specific regulations in every Country as for the disposal of these materials and the environment protection. The Customer is required to be knowledgeable in the Laws in force in his own Country and to operate only while complying with these regulations, according to the indications in the product technical charts, which may be obtained from the Manufacturer.



WARNING!

The Laws in force about the disposal of mineral oils or greases used for the lubrication / maintenance operations must be followed.



WARNING!

More information about the disposal of oils and other substances can be found in the safety chart of the substances.

The steps employed in the disposal of toxic waste including the collecting, transporting, processing (transformation for recycling), as well as the deposit and the dumping onto the ground are all usual activities of common interest and are subject to the following general principles:

- a) Any risks of injuries or dangers for the health and safety of any individual and of the community have to be avoided.
- b) Compliance with any and all hygienic-sanitary requirement and avoidance of any air, water, ground and underground pollution have to be guaranteed.

Compliance with efficient and economical principles in order to save and recycle energy and materials shall be promoted.

11.2 Indications for special waste

Special waste is that deriving from industrial processes as well as from materials of dismantled equipment and de-teriorated and obsolete machineries.

The special (also toxic and harmful) waste producers shall provide for its disposal directly or through qualified, authorised companies or bodies, or shall deliver them to public service after having made an agreement.

When disposing of special waste, check with the relevant local government authority for any available information regarding such waste disposal in your region.



WARNING!

Any unauthorised disposal by the owner of a product is followed by the application of the sanctions due to the regulations in force.



WARNING!

In compliance with the Directive 2012/19/EU on RAEE any bought element/equipment marked with the symbol of the crossed dustbin means that it has to be collected, at the end of its working life, separately from other waste:

The separate collection of the element/equipment, at the end of its working life, shall be managed by the Manufacturer. The user shall, therefore, contact the Manufacturer and follow the procedures established by the Manufacturer himself for the separate collection of an end-of-life equipment. The adequate separate collection and the following processing and eco-friendly disposal avoid negative effects on the health and the environment and allow the recycling of the materials the products are made of. Any unauthorised disposal, personally carried out by the end-user, would cause the application of sanctions, according to the local Laws.



Nous vous remercions d'avoir choisi un Générateur Campagnola by RATO.

Cette notice contient les informations sur son utilisation. Veuillez la lire attentivement avant de l'utiliser. Travailler en toute sécurité et correctement peut vous aider à obtenir de meilleurs résultats.

Toutes les informations contenues dans cette publication se basent sur les informations concernant les produits les plus récents disponibles au moment de l'impression. Des parties de cette notice peuvent différer en raison des révisions et d'autres modifications.

Notre entreprise se réserve le droit d'apporter des modifications à tout moment sans préavis et sans encourir aucune obligation. Aucune partie de cette publication ne peut être reproduite sans l'autorisation écrite de notre entreprise.

Ce manuel doit être considéré partie intégrante du Générateur et doit l'accompagner en cas de revente.

MISES EN GARDE DE SÉCURITÉ



AVERTISSEMENT !

Votre sécurité personnelle et la sécurité de vos biens et des autres sont très importantes. Nous vous prions de lire attentivement les messages précédés du symbole.



DANGER !

Le risque de MORT ou de BLESSURES graves subsiste en cas de non-respect des instructions.



MISE EN GARDE !

Le risque de MORT ou de BLESSURES graves subsiste en cas de non-respect des instructions.



ATTENTION !

Le risque de BLESSURES subsiste en cas de non-respect des instructions.

AVERTISSEMENT !

Le Générateur ou d'autres biens pourraient être endommagés en cas de non-respect des instructions.

TABLE DES MATIÈRES

MISES EN GARDE DE SÉCURITÉ	42
1 CONSIGNES DE SÉCURITÉ	44
2 EMPLACEMENT DES ÉTIQUETTES IMPORTANTES	46
3 DESCRIPTION	47
3.1 Panneau de contrôle	47
4 CONTRÔLE DES FONCTIONS	48
4.1 Soupape du carburant	48
4.2 Levier de démarrage	48
4.3 Témoin de l'huile (rouge)	48
4.4 Témoin de surcharge (rouge)	49
4.5 Témoin lumineux AC (vert)	49
4.6 Protection DC	49
4.7 Interrupteur du Générateur	49
4.8 Interrupteur Intelligent (C)	50
4.9 Bouchon du réservoir de carburant	50
4.10 Bouton de purge de l'air sur le bouchon du réservoir du carburant.....	50
4.11 Terminal de mise à la terre	50
5 PRÉPARATION	51
5.1 Carburant	51
5.2 Ravitaillement en carburant	51
5.3 Huile moteur	51
5.4 VÉRIFICATION AVANT UTILISATION	52
6 FONCTIONNEMENT	52
6.1 Démarrage du moteur	52
6.2 Arrêt du moteur	53
6.3 Branchement en courant alternatif (CA)	53
6.4 Domaine d'application	54
7 ENTRETIEN	55
7.1 Inspection de la bougie	56
7.2 Réglage du carburateur	56
7.3 Remplacement de l'huile moteur	56
7.4 Filtre à air	56
7.5 Écran du silencieux et du pare-étincelles	57
7.6 Filtre du réservoir de carburant	57
8 CONSERVATION	58
8.1 Vidange de carburant	58
9 RÉOLUTION DES PROBLÈMES	58
10 SPÉCIFICATIONS TECHNIQUES	59
11 DÉMOLITION ET ÉLIMINATION DES COMPOSANTS	59
11.1 Élimination des matériaux épuisés	59
11.2 Indications pour les déchets spéciaux	60

1 CONSIGNES DE SÉCURITÉ

Lire et comprendre cette notice d'utilisation avant de mettre le Générateur en marche. La connaissance des procédures de fonctionnement du générateur en toute sécurité vous aidera à éviter d'éventuels accidents.

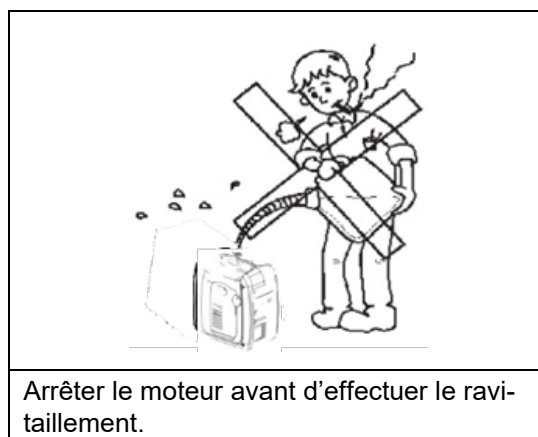
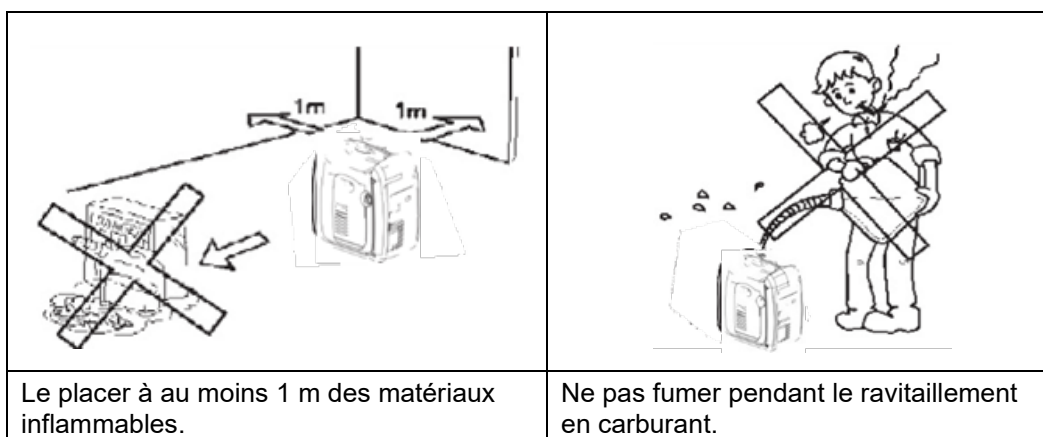
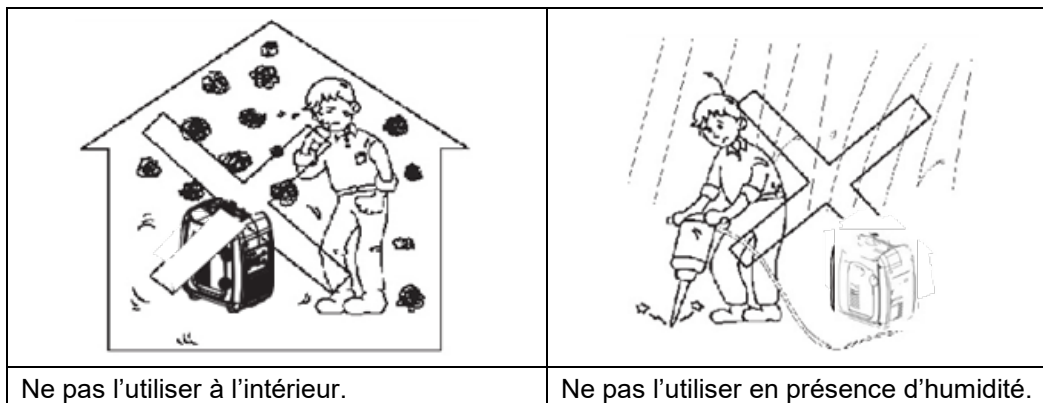

ATTENTION!

Branchement à l'alimentation électrique domestique.

Si le Générateur doit être branché à une alimentation électrique domestique, le branchement doit être effectué par un électricien professionnel ou par une personne ayant des compétences électriques adéquates.

Lorsque les charges sont reliées au Générateur, vérifier attentivement si les branchements électriques sont sûrs et fiables. Un mauvais branchement peut endommager le Générateur ou provoquer un incendie.

DANGER!

Le générateur n'est PAS un chargeur de batterie et ne peut pas être utilisé comme tel car il n'est équipé d'aucun système de contrôle et de protection du courant fourni.

L'utilisation comme chargeur de batterie **N'EST PAS AUTORISÉE ET INTERDITE PAR LE FABRICANT**, elle est dangereuse et peut endommager la batterie, le générateur, en cas d'incendie peut provoquer des blessures graves.

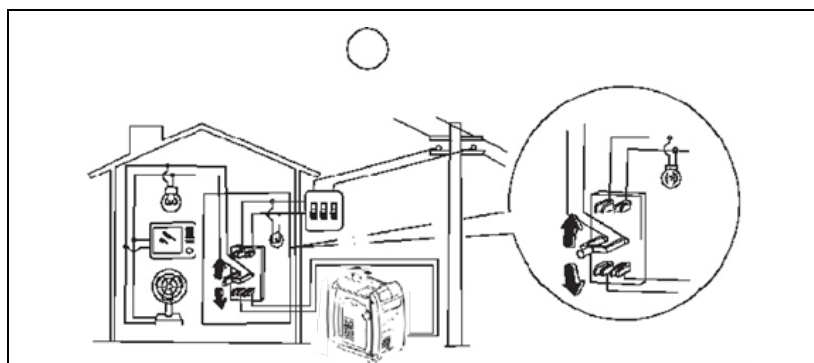
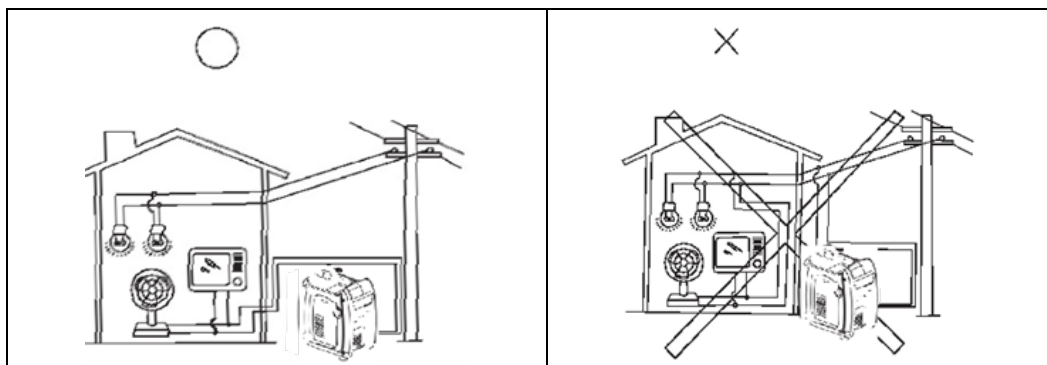

Circuit de mise à la terre du Générateur

Pour éviter les chocs électriques causés par des appareils électriques de mauvaise qualité ou par une mauvaise utilisation de l'électricité, le générateur doit être mis à la terre avec un conducteur isolé de bonne qualité.

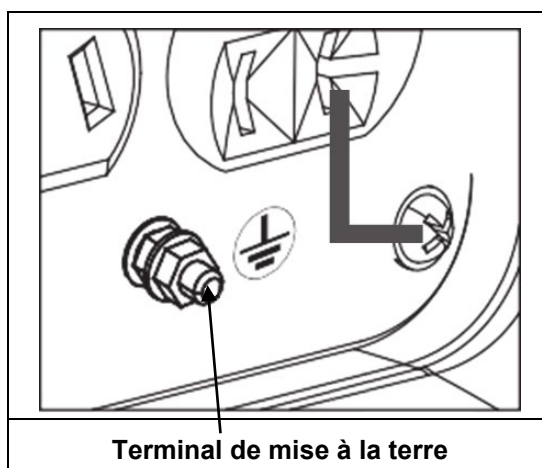

ATTENTION!

S'assurer que le panneau de contrôle, la prise d'air et les côté inférieur de l'inverseur sont bien froids et qu'il n'y ait pas d'impureté, de boue et d'eau. Le blocage de la purge de refroidissement peut endommager le moteur, le variateur ou l'alternateur.

Ne pas empiler le Générateur avec d'autres objets en cas de déplacement, de remisage ou de fonctionnement de l'unité. Cela peut causer des dommages au Générateur ou compromettre la sécurité des biens si le générateur fuit.

2 EMPLACEMENT DES ÉTIQUETTES IMPORTANTES





ATTENTION!

Lire attentivement les tableaux ci-dessous avant d'utiliser cette machine.

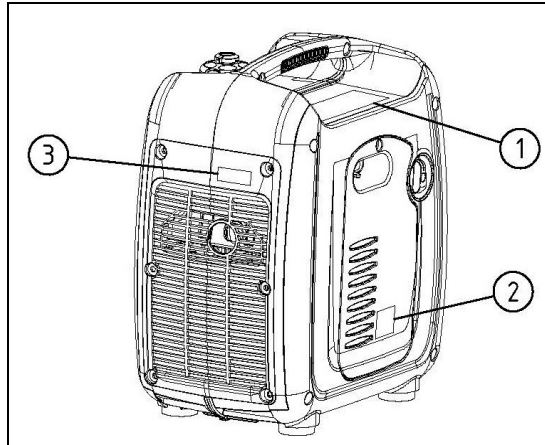
CONSEIL : Laisser ou remplacer les étiquettes d'instruction et de sécurité, si nécessaire.



 WARNING	
1	<ul style="list-style-type: none">● Read the owner's manual and all labels before operating.● Only operate in well-ventilated areas. Exhaust gas contains poisonous carbon monoxide.● Check for spilled fuel or fuel leaks.● Stop engine before refueling.● Do not operate near flammable materials.● Electrocutation can occur if generator is used in rain, snow, or near water. Keep this unit dry at all times.● Electrocutation or property damage can occur. Do not connect this generator to any building's electrical system unless an isolation switch has been installed by a licensed electrician. Refer to the owner's manual.● When operating the generator:<ul style="list-style-type: none">Never place a partition or other barrier around the generator.Do not cover the generator with a box.Do not place any objects on the generator.● Turn the fuel tank cap air vent knob to "OFF" after the engine has completely cooled down.
2	
3	

3 DESCRIPTION

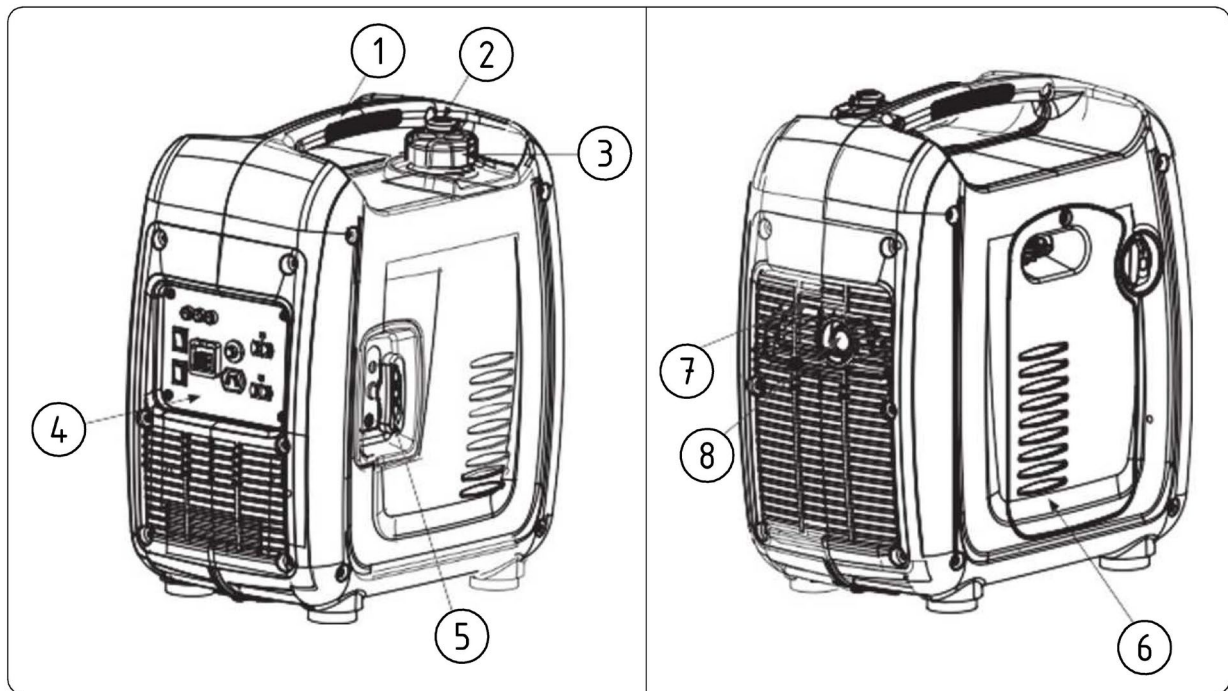

Pos.	Nom
1	Poignée de transport
2	Bouton de purge de l'air sur le bouchon du réservoir du carburant
3	Bouchon du réservoir de carburant
4	Panneau de contrôle
5	Démarrateur à rappel
6	Bouchon de remplissage de l'huile
7	Prise d'air
8	Silencieux

3.1 Panneau de contrôle

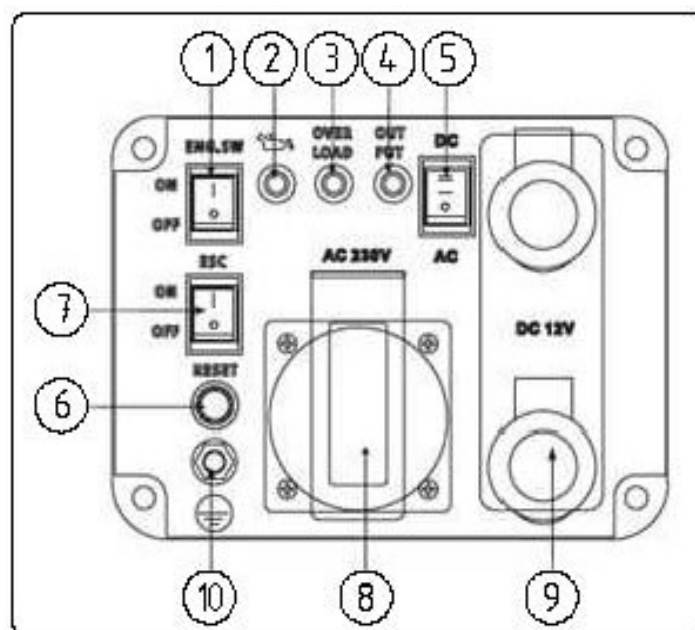

Pos.	Nom
1	Interrupteur Général
2	Témoin de l'huile
3	Témoin de Surcharge
4	Témoin lumineux AC
5	Interrupteur AC/DC (AC Courant alternatif DC Courant continu)
6	AC Reset
7	ESC (Contrôle intelligent du moteur)
8	Prise AC
9	Connexions (+/-) DC
10	Terminal de mise à la terre

4 CONTRÔLE DES FONCTIONS

4.1 Soupape du carburant

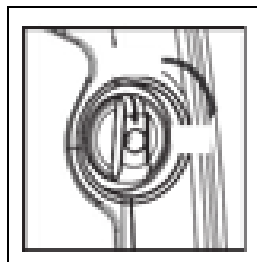

La soupape du carburant contrôle le flux de carburant du réservoir au carburateur. Veiller à ramener le levier sur « OFF » après l'arrêt du moteur.

4.2 Levier de démarrage

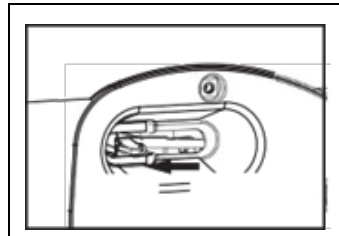

Le levier de démarrage sert à fournir un mélange de carburant enrichi en cas de démarrage d'un moteur froid. Amener lentement le levier de démarrage en position « OUVERT » après que le moteur a été démarré.

CONSEIL : Le starter n'est pas nécessaire pour démarrer un moteur chaud.

4.3 Témoin de l'huile (rouge)



Lorsque le niveau de l'huile baisse sous le minimum, le témoin lumineux ① s'allume, le moteur s'arrête automatiquement.

Si le niveau de l'huile n'est pas rétabli, le moteur ne redémarre pas.

CONSEIL : Si le moteur cale ou ne démarre pas, placer l'interrupteur du moteur sur « ON » et tirer sur le démarreur à rappel. Si le témoin de l'huile clignote pendant quelques secondes, cela signifie que l'huile moteur est insuffisante. Ajouter de l'huile et redémarrer.

4.4 Témoin de surcharge (rouge)

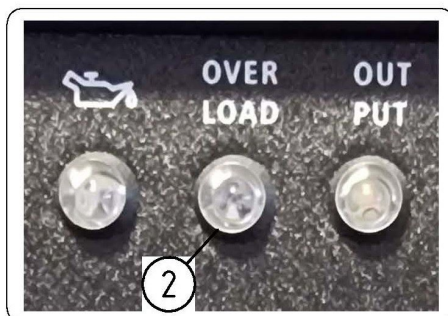

Le témoin de surcharge ② s'allume en cas de détection d'une surcharge d'un dispositif électrique branché, la boîte du variateur surchauffe ou la tension de sortie AC augmente. Ensuite, la protection AC se déclenchera, ce qui interrompt la production d'énergie afin de protéger le Générateur et tous les dispositifs électriques éventuellement branchés. Le témoin lumineux AC (vert) s'éteint et le témoin de surcharge (rouge) reste allumé, mais le moteur ne s'arrête pas. Lorsque le témoin de surcharge s'allume et que la production d'électricité s'arrête, procéder comme suit :

1. Éteindre tous les dispositifs électriques branchés et arrêter le moteur.
2. Réduire la puissance totale des dispositifs électriques branchés dans la plage de la puissance nominale.
3. Vérifier qu'il n'y ait pas d'obstructions à l'entrée de l'air de refroidissement et autour de l'unité de commande ; s'il y a des obstructions, les éliminer.
4. Après avoir contrôlé, redémarrer le moteur.

Conseil : Le témoin lumineux de surcharge peut s'allumer pendant quelques secondes lors de l'utilisation d'appareils électriques nécessitant un courant de démarrage important, comme un compresseur ou une pompe à immersion. Il ne s'agit toutefois pas d'un dysfonctionnement.

4.5 Témoin lumineux AC (vert)

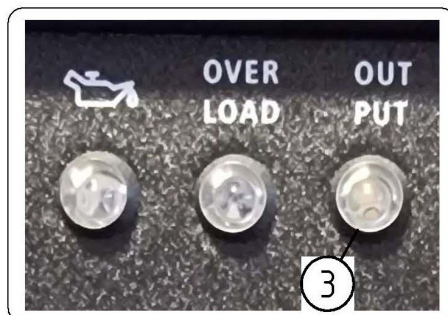

Le témoin lumineux AC ③ s'allume lorsque le moteur démarre et produit de la puissance.

4.6 Protection DC

4.7 Interrupteur du Générateur

① - **On** : Démarrer le Générateur

② - **Off** : Arrêter le Générateur

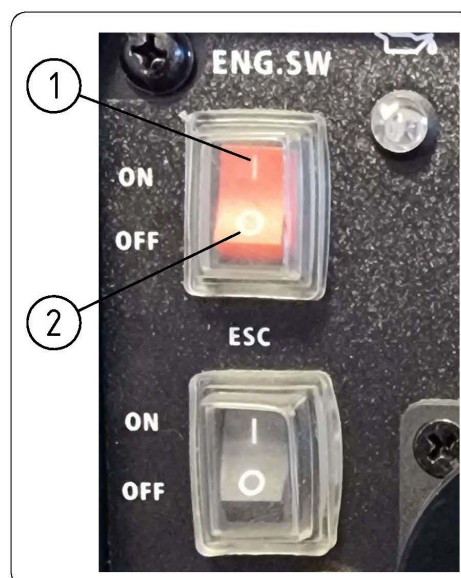

4.8 Interrupteur Intelligent (C)

La fonction intelligente, si elle est activée (interrupteur 1 « ON ») permet au moteur de tourner au ralenti avec une consommation de carburant réduite, dans des conditions d'absence ou de faible charge ; lorsque la charge augmente, les tours du moteur augmentent aussi pour fournir plus de puissance.

Avec la fonction intelligente désactivée (interrupteur sur 0 « OFF »), le moteur tourne toujours au maximum pour fournir immédiatement la puissance maximale ; cette fonction est utile lorsqu'il faut démarrer des outils électriques à forte absorption au démarrage.

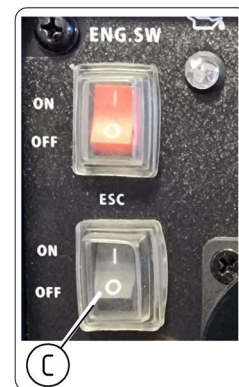

4.9 Bouchon du réservoir de carburant

Enlever le bouchon du réservoir de carburant en le faisant tourner dans le sens antihoraire.

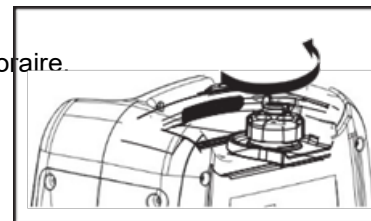

4.10 Bouton de purge de l'air sur le bouchon du réservoir du carburant

Le bouchon du réservoir de carburant (2) est équipé d'un bouton rotatif de purge de l'air pour (1) arrêter le flux de carburant.

Le bouton rotatif de purge de l'air doit être sur « ON ». Cela permettra au carburant de s'écouler dans le carburateur et au moteur de fonctionner.

Lorsque le moteur n'est pas utilisé, tourner le bouton rotatif de purge de l'air sur « OFF » pour arrêter le débit de carburant.

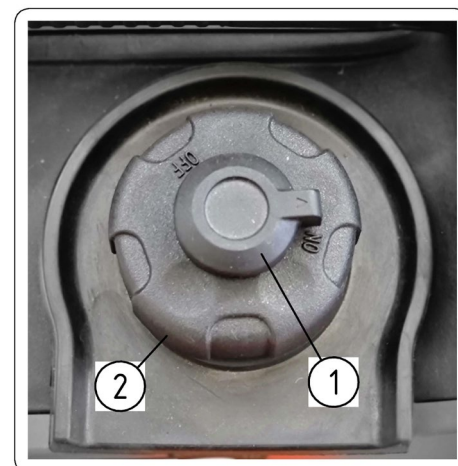

4.11 Terminal de mise à la terre

Terminal de mise à la terre (1)



ATTENTION!

À ne brancher qu'en cas d'utilisation du Générateur branché sur le secteur en courant alternatif à 220 V.



5 PRÉPARATION

5.1 Carburant



ATTENTION!

Le carburant est hautement inflammable et toxique. Lire attentivement les « INFORMATIONS DE SÉCURITÉ » avant le remplissage.

- Ne pas trop remplir le réservoir de carburant car il risque de déborder lorsque le carburant chauffe et se dilate.
- Après avoir rempli le réservoir de carburant, veiller à ce que le bouchon du réservoir de carburant soit bien serré.



AVERTISSEMENT !

- Nettoyer immédiatement le carburant qui s'est déversé avec un chiffon doux, propre et sec car il risque d'endommager les surfaces peintes ou les pièces en plastique.
- N'utiliser que de l'essence sans plomb. L'utilisation d'essence avec du plomb entraîne de graves dommages aux pièces intérieures du moteur.

5.2 Ravitaillement en carburant



ATTENTION !

Le carburant est hautement inflammable et toxique. Lire attentivement les « INFORMATIONS DE SÉCURITÉ » avant le remplissage.

- Ne pas trop remplir le réservoir de carburant car il risque de déborder lorsque le carburant chauffe et se dilate.
- Après avoir rempli le réservoir de carburant, veiller à ce que le bouchon du réservoir de carburant soit bien serré.



ATTENTION !

- Nettoyer immédiatement le carburant qui s'est déversé avec un chiffon doux, propre et sec car il risque d'endommager les surfaces peintes ou les pièces en plastique.
- N'utiliser que de l'essence sans plomb. L'utilisation d'essence avec du plomb entraîne de graves dommages aux pièces intérieures du moteur.



AVERTISSEMENT !

Pour effectuer le ravitaillement, enlever le bouchon du réservoir du carburant et remplir le réservoir jusqu'au niveau rouge ①.

Carburant recommandé :

Essence sans plomb

Capacité du réservoir de carburant :

Totale : 2,5 l



5.3 Huile moteur



ATTENTION !

Le Générateur est envoyé sans huile moteur. Ne pas démarrer le moteur tant qu'il n'a pas été rempli avec une quantité suffisante d'huile moteur.



- Placer le Générateur sur une surface plate.
- Retirer les vis ① puis enlever le couvercle ②.
- Enlever le bouchon de remplissage de l'huile ③.
- Remplir la quantité spécifiée de l'huile moteur conseillée, remonter le bouchon de l'huile ③.
- Remonter le couvercle ②, serrer la vis ①.

Huile moteur recommandée :	SAE SJ 15W-40
Degré de l'huile moteur recommandé :	Type API Service SE ou type supérieur
Quantité d'huile moteur :	0,31 l

5.4 VÉRIFICATION AVANT UTILISATION



AVERTISSEMENT !

- Avant de démarrer le Générateur, vérifier qu'il est intact dans toutes ses parties ; s'il est endommagé, le faire réparer avant de le mettre en service, les composants vitaux peuvent commencer à se détériorer rapidement et de manière inattendue, même si le Générateur n'est pas utilisé.
- La vérification de l'état d'un Générateur est la responsabilité de son propriétaire.
- Les contrôles avant utilisation doivent être effectués à chaque utilisation du Générateur.
- Avant utilisation, vérifier le niveau de **carburant** (voir par. 5.2), le compléter si nécessaire.
- Avant utilisation, vérifier le niveau d'**huile moteur** (voir par. 5.3), le compléter si nécessaire.
- Avant utilisation, vérifier que le Générateur ne présente pas de fuites d'huile.

En cas d'anomalies non décrites dans ce manuel, contactez un atelier agréé.

6 FONCTIONNEMENT



ATTENTION !

Ne jamais actionner le moteur dans un espace clos car les gaz d'échappement risquent de provoquer une perte de conscience et même la mort en peu de temps. Faire fonctionner le moteur dans un espace bien aéré.

- Avant de démarrer le Générateur, ne brancher aucun appareil électrique.
- Le Générateur est expédié sans huile moteur, ne pas démarrer le moteur tant qu'il n'a pas été rempli avec la quantité indiquée (voir par. 5.3).
- Ne pas incliner le Générateur en ajoutant de l'huile moteur car cela risque d'entraîner un remplissage excessif et d'endommager le moteur.
- Le Générateur peut être utilisé avec la charge nominale de sortie dans les conditions atmosphériques standards :
 - Température ambiante : 25 °C
 - Pression barométrique : 100 kPa
 - Humidité relative : 30 %.
- La puissance du Générateur varie en fonction du changement de température, d'altitude (pression atmosphérique inférieure à haute altitude) et d'humidité.
- La puissance du Générateur diminue lorsque la température, l'humidité et l'altitude sont supérieures aux conditions atmosphériques standards.
- La charge doit être réduite en cas d'utilisation dans des espaces confinés, car le refroidissement du Générateur en est affecté.

6.1 Démarrage du moteur

- 1- Placer le bouton rotatif de purge sur « ON » ①



- 2- Tourner le robinet du carburant ② en position A ;

- 3- Déplacer le levier du Starter ③ sur B ;

Le Générateur est prêt au démarrage.



AVERTISSEMENT !

Pour démarrer le Générateur avec le moteur chaud, le levier du starter doit rester en position « **OPEN** ».

- 4- Tirer lentement la poignée du démarreur à réenrouleur ② jusqu'à ce qu'elle s'enclenche, puis la tirer rapidement pour démarrer le moteur.



ATTENTION !

Saisir fermement la poignée de transport ① pour empêcher le Générateur de tomber en tirant sur le démarreur à réenrouleur

- 5- Après quelques minutes de fonctionnement du moteur, remettre le levier du starter en position **OPEN**.

6.2 Arrêt du moteur

AVERTISSEMENT !

- Avant d'arrêter le moteur du Générateur, éteindre tous les dispositifs électriques branchés.
- Amener l'interrupteur du Générateur sur « **OFF** » (cf. par. 4.7).
- Tourner le robinet du carburant en position « **0** » **CLOSE**.

Le circuit d'allumage est éteint, le carburant est fermé.



- Après le refroidissement complet du moteur, tourner le bouton rotatif de purge de l'air sur « **OFF** » - 1.



6.3 Branchement en courant alternatif (CA)

ATTENTION !

- Veiller à ce que tous les dispositifs électriques soient éteints avant de les brancher au Générateur.
- Veiller à ce que tous les dispositifs électriques, y compris les câbles et les connecteurs à fiche, soient en bon état avant de les brancher sur le Générateur.
- Veiller à ce que la charge totale se trouve dans l'intervalle de la puissance nominale du Générateur.
- Veiller à ce que le courant de charge de la prise se trouve dans l'intervalle de courant nominal de la prise.

REMARQUE : si le Générateur est branché au réseau en courant alternatif à 220 V, le Générateur doit également être connecté à la terre via la borne de terre (voir par. 4.11).



ATTENTION !

En cas d'utilisation des outils à 12 V, l'interrupteur intelligent « ESC » (cf. par. 4.8) doit être obligatoirement sur 1 « ON »).

6.4 Domaine d'application

ATTENTION !

Lors de l'utilisation du Générateur, veiller à ce que la charge totale se trouve dans l'intervalle de la puissance nominale du Générateur. Sinon, il y a un risque de dommages pour le Générateur.

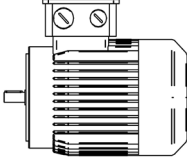
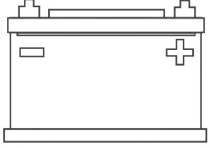
				
AC				DC
Facteur de puissance	1	0.8-0.95	0.4-0.75 (Rendement 0,85)	
IkW	<=1 000 W	<=800 W	<=400 W	Tension nominale 12 V

ATTENTION !

- La puissance d'application indique à quel moment chaque dispositif est utilisé seul.

EXEMPLE :

Puissance nominale de sortie du Générateur		1 000 W
Fréquence	Facteur de puissance	
AC	1,0	<= 1.000 W
	0,8	<= 800 W
DC	---	700 W(12 Vx58.3 A)

ATTENTION !

Le témoin lumineux de surcharge ② s'allume lorsque la puissance totale dépasse les données nominales (cf. par. 10).



ATTENTION !

- Ne pas surcharger ; la charge totale de tous les appareils électriques connectés ne doit pas dépasser les données nominales du Générateur. Toute surcharge endommage le Générateur.
- En alimentant des équipements de précision, des contrôleurs électroniques, des PC, des ordinateurs électroniques, des équipements basés sur des micro-ordinateurs ou des chargeurs de batterie, laisser le Générateur suffisamment loin pour éviter les interférences électriques. Veiller également à ce que les fréquences émises par le Générateur n'interfèrent pas avec d'autres appareils électriques et électroniques situés à proximité.
- Si le Générateur doit alimenter un équipement médical, il faut d'abord consulter le fabricant ou un professionnel de la santé.
- Certains appareils électriques ou moteurs électriques à usage général ont des courants de démarrage élevés et ne peuvent donc pas être utilisés, même s'ils se situent dans les intervalles d'alimentation indiqués dans le tableau ci-dessus. Consulter le fabricant de l'équipement pour plus de conseils.

7 ENTRETIEN

ATTENTION !

- Avant d'effectuer toute opération d'entretien ordinaire, arrêter le Générateur.
- Toutes les opérations d'entretien qui ne sont pas expliquées dans ce manuel doivent être effectuées auprès des centres d'assistance agréés.



Les opérations d'entretien ordinaire peuvent être effectuées par les opérateurs.

ATTENTION !

- Le moteur doit être correctement entretenu pour assurer un fonctionnement sûr, financièrement avantageux et sans problème, ainsi que respectueux de l'environnement. Pour maintenir le moteur à essence en bon état de fonctionnement, il doit être soumis à un entretien périodique. Il faut donc suivre attentivement le programme d'entretien et les procédures d'inspection de routine suivants :

Composant	Fréquence	À chaque fois	Le premier mois ou les 20 premières heures de fonctionnement	Ensuite, tous les 3 mois ou toutes les 50 heures de fonctionnement	Tous les ans ou toutes les 100 heures de fonctionnement
		✓	✓	✓	✓
Huile moteur	Contrôle - Recharge	✓			
	Remplacement		✓	✓	
Filtre à air	Contrôle	✓			
	Nettoyage		✓		
	Remplacement			✓	
Bougie d'allumage	Contrôle-réglage				✓
	Remplacement	Tous les ans ou toutes les 250 heures de fonctionnement			
Pare-étincelles	Nettoyage				
Fonctionnement au minimum (s'il est fourni) *	Contrôle-réglage				✓
Réservoir et filtre du carburant *	Nettoyage				✓
Tuyau du carburant	Contrôle	Tous les 2 ans (changer si nécessaire)			

* Ces composants doivent être entretenus et réparés par notre revendeur agréé.

ATTENTION !

Arrêter le moteur avant de procéder à l'entretien. Placer le moteur sur une surface plane et retirer le capuchon de la bougie pour empêcher le moteur de démarrer.

Ne pas faire tourner le moteur dans un endroit mal aéré ou dans un autre endroit clos. S'assurer de maintenir une bonne ventilation dans la zone de travail. L'échappement du moteur peut contenir du CO toxique, l'inhalation peut provoquer un choc, une perte de conscience et même la mort

ATTENTION !

- Si le moteur à essence fonctionne souvent à des températures élevées ou avec de lourdes charges, vidanger l'huile toutes les 25 heures.
- Si le moteur tourne souvent dans des conditions poussiéreuses ou dans d'autres circonstances difficiles, nettoyer l'élément filtrant de l'air toutes les 10 heures. Si nécessaire, remplacer l'élément filtrant de l'air toutes les 25 heures.
- Respecter les intervalles d'entretien indiqués.
- Si l'échéance prévue pour l'entretien du moteur n'a pas été respectée, y remédier dès que possible.



ATELIER AGRÉÉ

C'est l'atelier indiqué par nos revendeurs, autorisé à réparer les produits.

7.1 Inspection de la bougie



ATTENTION !

La bougie est un composant important du moteur qui doit être contrôlée périodiquement.

1. Retirer le couvercle ①, enlever le bouchon de la bougie ② ; en utilisant la clé incluse avec le Générateur, dévisser la bougie en la faisant tourner dans le sens antihoraire.
2. Vérifier qu'il n'y ait pas de résidus carbonneux sinon les éliminer à l'aide d'une brosse en acier.
3. Vérifier que la bougie corresponde au modèle indiqué : bougie standard **A5RTC**

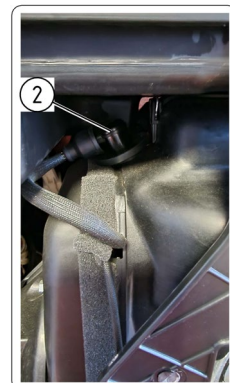

4. À l'aide d'une jauge à mètre, vérifier la distance entre les électrodes : 0,6-0,8 mm.
5. Remonter la bougie en appliquant un couple de serrage de 12,5 Nm
6. Remonter le bouchon de la bougie ② et le couvercle ①.

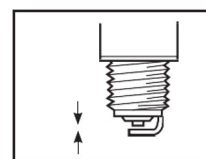

7.2 Réglage du carburateur



ATTENTION !

Le carburateur est un composant important du moteur ; son entretien et son réglage doivent être effectués par un centre d'assistance agréé.

7.3 Remplacement de l'huile moteur



ATTENTION !

- Éviter de vider l'huile moteur juste après l'arrêt du moteur. L'huile est chaude et doit être manipulée avec soin pour éviter toute brûlure.
- Pour le remplacement de l'huile, se reporter au Paragraphe 5.3.



ATTENTION !

Ne pas incliner le Générateur en ajoutant de l'huile moteur. Cela risque d'entraîner un remplissage excessif et d'endommager le moteur.

7.4 Filtre à air

- Placer le Générateur sur une surface plate.
- Retirer la vis ① puis enlever le couvercle ②.
- Retirer le couvercle du filtre ③.
- Enlever le filtre ③.
- Laver l'élément en mousse avec un détergent neutre et l'essuyer.
- Graisser l'élément en mousse et éliminer l'huile en excès. L'élément en mousse doit être humide mais il ne doit pas goutter.

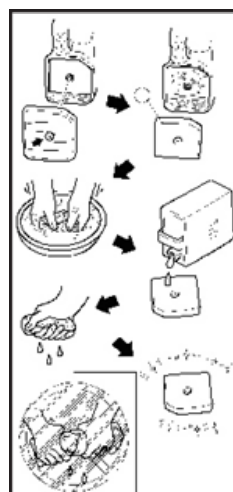

ATTENTION !

Ne pas tordre l'élément en mousse. Il risque de se déchirer.

- Insérer l'élément en mousse dans le corps du filtre à air, en s'assurant que la surface d'étanchéité de l'élément en mousse adhère au filtre à air afin qu'il n'y ait pas de fuites d'air.



ATTENTION !

Le moteur ne doit jamais tourner sans l'élément en mousse ; cela peut entraîner une usure excessive du piston et du cylindre.

- Remonter le couvercle du corps du filtre ③ à air dans sa position d'origine.
- Remonter le couvercle ② et serrer la vis ①.

7.5 Écran du silencieux et du pare-étincelles

ATTENTION !

Le moteur et le silencieux sont très chauds après que le moteur a tourné. Éviter de toucher le moteur et le silencieux encore chauds avec une partie de votre corps ou des vêtements pendant l'inspection ou la réparation.

- Retirer les vis ①, extraire le couvercle ②.
- Desserrer le boulon ③, retirer le collier métallique du silencieux ④.
- Retirer le capuchon du silencieux ⑤.
- Nettoyer tout dépôt de carbone sur le silencieux avec une brosse métallique.

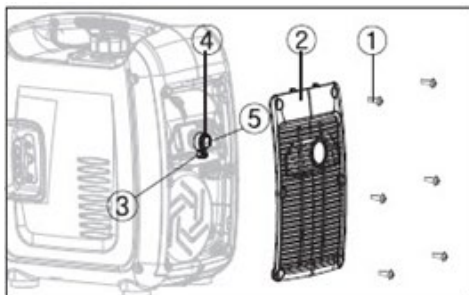

ATTENTION !

Pendant le nettoyage, utiliser délicatement la brosse métallique pour éviter d'endommager le silencieux.

- Si le silencieux est endommagé, le remplacer.
- Remonter le silencieux ⑤, le collier métallique ④, le couvercle ② et les vis ①.

7.6 Filtre du réservoir de carburant

ATTENTION !

Ne jamais utiliser d'essence en fumant ou à proximité d'une flamme nue.

- Enlever le bouchon du réservoir de carburant et le filtre.
- Nettoyer le filtre avec de l'essence et le remonter.
- Refermer le bouchon du réservoir de carburant.

ATTENTION !

Veiller à ce que le bouchon du réservoir de carburant soit bien serré.

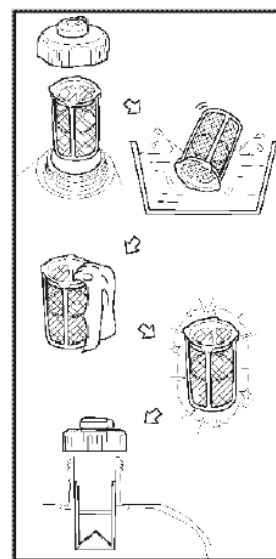

8 CONSERVATION

AVERTISSEMENT !

Si la machine est mise au repos pendant une longue période, il faut appliquer certaines procédures préventives pour la protéger contre la détérioration.

8.1 Vidange de carburant

- Tourner le robinet du carburant en position « 0 » **CLOSE**.
- Enlever le bouchon du réservoir de carburant et le filtre. Extraire le carburant du réservoir en le versant dans un bidon à essence homologué. Puis remonter le bouchon du réservoir de carburant.



ATTENTION !

Le carburant est hautement inflammable et toxique, nettoyer immédiatement le carburant qui s'est déversé avec un chiffon doux, propre et sec car il risque d'endommager les surfaces peintes ou les pièces en plastique.

AVERTISSEMENT !

Démarrer le moteur et le laisser tourner jusqu'à épuisement du carburant résiduel, ne pas brancher d'appareils électriques, cette opération doit se faire à vide. La durée du fonctionnement à vide du carburant restant dans le réservoir.

AVERTISSEMENT !

Nettoyer l'extérieur du Générateur, le conserver dans un endroit sec, bien aéré et à l'abri.

9 RÉOLUTION DES PROBLÈMES

ATTENTION !

Tous les travaux d'entretien extraordinaire doivent être effectués par un technicien d'entretien mécanique.

INCONVÉNIENT	CAUSE	SOLUTION
Le moteur ne démarre pas.	- Pas de carburant dans le réservoir. - Carburant dans le réservoir.	- Remplir le réservoir de carburant. - Vérifier la position de la soupape de purge sur le bouchon du réservoir (cf. par. 4.9) Vérifier la position du robinet de carburant (cf. par. 4.1).
	Carburateur bouché.	Remettre le Générateur à un Centre d'assistance agréé par le Fabricant.
Niveau faible de l'huile moteur (le témoin lumineux s'allume)	Manque d'huile.	Compléter le niveau d'huile sur le moteur (cf. par. 5.2).
Dysfonctionnement électrique/mécanique.	- Bougie sale ou mouillée. - Système d'allumage défectueux.	- Nettoyer et essuyer la bougie (cf. par. 7.1). - Remettre le Générateur à un Centre d'assistance agréé par le Fabricant.
Le Générateur ne produit pas d'énergie.	- Dispositif de sécurité (protection DC) sur « OFF ». - Le témoin lumineux AC (vert) s'éteint.	- Amener la protection DC sur « ON ». - Éteindre le moteur puis le redémarrer.

10 SPÉCIFICATIONS TECHNIQUES

Modèle		1 kW
Générateur	Type	Variateur silencieux
	Fréquence nominale (Hz)	50/60
	Tension nominale (V)	110/120/220/230/240
	Puissance de sortie nominale (kW)	1,0
	Facteur de puissance	1
	Capacité du réservoir de carburant (l)	2,5
	Qualité de la sortie CA	ISO8528 G2
	Tension de charge (DC) (V)	12
	Courant de charge (DC) (A)	58.3
	Puissance (DC) (W)	700
	Protection contre les surcharges (DC)	Protection sans fusibles
Moteur	Moteur	R60-i
	Type de moteur	Monocylindre, 4 temps, refroidissement par air forcé, OHV
	Cylindrée (c ³)	60
	Type de carburant	Essence sans plomb
	Temps de fonctionnement continu (à la puissance nominale) (h)	4
	Capacité de l'huile (l)	0,31
	N° du modèle de bougie	ASRTC
	Mode de démarrage	Démarrage à réenrouleur
Générateur	Longueur x largeur x hauteur (mm)	380×240×420
	Poids net (kg)	13

11 DÉMOLITION ET ÉLIMINATION DES COMPOSANTS

11.1 Élimination des matériaux épuisés

Suite à l'installation et au cours de son fonctionnement normal, la machine ne comporte pas de contamination environnementale mais durant toute la période d'utilisation, certains déchets ou matériaux épuisés sont produits dans des conditions particulières (par exemple la graisse de lubrification des pièces mécaniques).

Pour l'élimination de ces matériaux, chaque pays possède des règles spécifiques de protection de l'environnement. Le client est tenu de connaître les lois en vigueur dans son pays et d'opérer de manière à obtempérer à ces législations conformément aux indications reportées sur les fiches techniques des produits utilisés à demander au Fabricant.



ATTENTION !

Respecter les lois en vigueur en matière d'élimination des huiles minérales ou des graisses utilisées pour la lubrification/l'entretien.



ATTENTION !

Vous trouverez de plus amples informations sur les procédures d'élimination des huiles et des autres substances sur la fiche de sécurité des substances en question.

L'élimination des déchets toxiques au cours des phases de collecte, de transport, de traitement (au sens d'opération de transformation nécessaire à la récupération) ainsi que le stockage et la décharge sur le sol, sont des activités d'intérêt public soumises au respect des principes généraux suivants :

- a) Il faut éviter tout dommage ou risque pour la santé et protéger l'intégrité physique et la sécurité de la collectivité et des personnes.
- b) Il faut garantir le respect des exigences hygiéniques et sanitaires et éviter tout risque de pollution de l'air, de l'eau, du sol et du sous-sol.

Il faut promouvoir, en respectant les critères économiques et efficaces, les systèmes de récupération et de recyclage des matériaux et de l'énergie.

11.2 Indications pour les déchets spéciaux

Les résidus issus des usinages industriels et les matériaux provenant des démolitions d'équipements et des machines détériorées et obsolètes sont des déchets spéciaux.

Les producteurs des déchets sont tenus de pourvoir à l'élimination des déchets spéciaux, même toxiques et nocifs, directement ou par le biais d'entreprises ou d'organismes autorisés ou en les remettant aux sujets qui gèrent le service public et avec lesquels une convention spécifique a été stipulée.

Chaque pays ou chaque municipalité est tenu de fournir à la région toutes les informations disponibles sur l'élimination des déchets sur son territoire.



ATTENTION !

L'élimination abusive du produit de la part du détenteur comporte l'application des sanctions administratives prévues par les réglementations en vigueur.



ATTENTION !

Conformément à la Directive « DEEE » 2012/19/UE, si le composant/produit acheté est marqué avec le symbole de la poubelle sur roues barrée d'une croix, cela signifie que le produit, à la fin de sa vie utile doit être collecté séparément des autres déchets.

Le tri sélectif de ce composant/produit à la fin de sa vie utile est organisé et géré par le fabricant. L'utilisateur qui voudra se débarrasser de cet équipement devra donc contacter le fabricant et suivre le système que ce dernier a adopté afin de permettre la collecte séparée de l'équipement à la fin de sa vie utile. Le tri sélectif approprié visant à destiner l'équipement hors d'usage au recyclage, au traitement et à l'élimination dans le respect de l'environnement contribue à éviter les effets nocifs pour l'environnement et la santé et facilite le réemploi et/ou le recyclage des matériaux dont il est composé. L'élimination abusive du produit de la part de l'utilisateur comporte l'application des sanctions prévues par les lois en vigueur au niveau local.



Gracias por haber escogido un generador Campagnola by RATO.

Este manual contiene la información para que pueda saber cómo utilizarlo. Se ruega leerlo atentamente antes del uso. Trabajar de manera segura y correcta le puede ayudar a conseguir los mejores resultados.

Toda la información incluida en este documento se basa en las informaciones sobre los productos más recientes que están a disposición cuando se ha redactado. El contenido de este manual puede ser diferente de las partes realmente en su poder debido a revisiones o a otro tipo de cambios realizados.

Nuestra empresa se reserva el derecho a realizar modificaciones en cualquier momento y sin previo aviso, sin obligación de comunicarlo. No se puede publicar ninguna parte de este manual, ni puede ser reproducida sin el permiso por escrito de nuestra empresa.

Este manual debe considerarse parte permanente del generador y debe acompañarlo en caso de cesión a terceros.

ADVERTENCIAS SOBRE LA SEGURIDAD

¡AVISO!

La seguridad personal y la de la su propiedad personal y de terceros es muy importante. Se ruega leer atentamente los mensajes que aparecen con este símbolo delante.

¡PELIGRO!

Existe el riesgo de FALLECIMIENTO o de LESIONES graves si no se cumplen estas instrucciones.

¡ADVERTENCIA!

Existe el peligro de FALLECIMIENTO o de LESIONES graves si no se cumplen estas instrucciones.

¡ATENCIÓN!

Existe el peligro de LESIONES si no se cumplen estas instrucciones.

¡AVISO!

El generador u otros bienes pueden dañarse en caso de que no se cumplan estas instrucciones.

ÍNDICE

ADVERTENCIAS SOBRE LA SEGURIDAD	61
1 INDICACIONES SOBRE LA SEGURIDAD	63
2 POSICIÓN DE LAS ETIQUETAS IMPORTANTES	65
3 DESCRIPCIÓN	66
3.1 Panel de control	66
4 CONTROL DE LAS FUNCIONES	67
4.1 Válvula de combustible	67
4.2 Palanca de arranque.....	67
4.3 Indicador de aceite (rojo)	67
4.4 Indicador de sobrecarga (rojo).....	68
4.5 Indicador piloto de CA (verde)	68
4.6 Protección de CC	68
4.7 Interruptor del generador	68
4.8 Interruptor Inteligente (C).....	69
4.9 Tapón del depósito de combustible	69
4.10 Pomo de purga de aire en el tapón del depósito del combustible.....	69
4.11 Terminal de tierra	69
5 PREPARACIÓN	70
5.1 Combustible	70
5.2 Repostaje de combustible.....	70
5.3 Aceite para motor.....	70
5.4 COMPROBACIÓN ANTES DEL USO	71
6 FUNCIONAMIENTO	71
6.1 Arranque del motor	71
6.2 Parada del motor	72
6.3 Conexión en corriente alterna (CA)	72
6.4 Campo de aplicación	73
7 MANTENIMIENTO	74
7.1 Inspección de la bujía	75
7.2 Ajuste del carburador	75
7.3 Sustitución del aceite para motor	75
7.4 Filtro del aire	75
7.5 Pantalla del silenciador y salvachispas	76
7.6 Filtro del depósito de combustible	76
8 CONSERVACIÓN	77
8.1 Vaciado del combustible	77
9 SOLUCIÓN DE PROBLEMAS	77
10 ESPECIFICACIONES TÉCNICAS	78
11 DESGUACE Y ELIMINACIÓN DE LOS COMPONENTES	78
11.1 Eliminación de los materiales usados.....	78
11.2 Indicaciones para los residuos especiales	79

1 INDICACIONES SOBRE LA SEGURIDAD

Lea y comprenda este manual antes de poner en marcha el generador. Conocer bien las fases de funcionamiento en condiciones de seguridad del generador, le ayudará a evitar posibles accidentes.

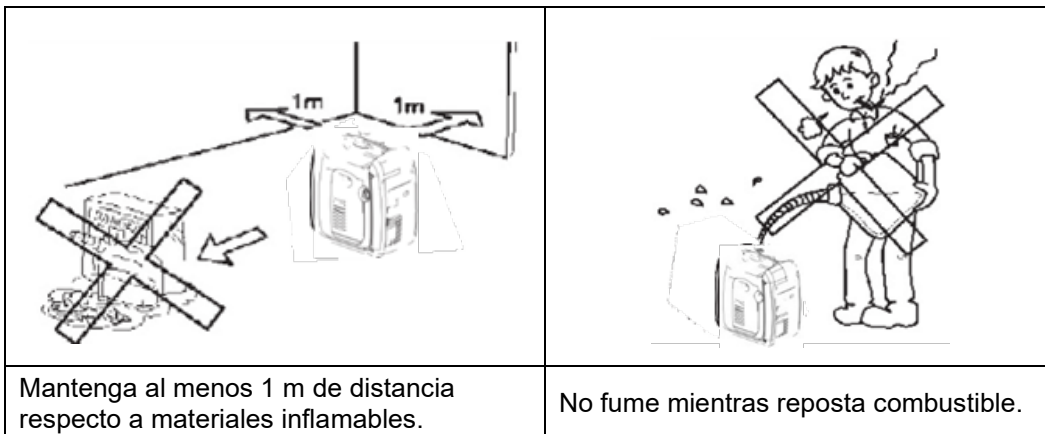
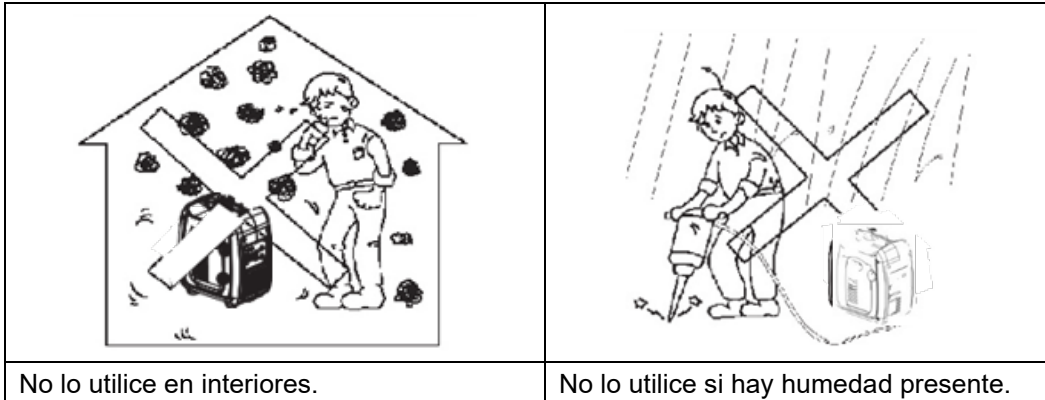

¡AVISO!

Conexión a la alimentación eléctrica doméstica

Si el generador debe conectarse a un alimentador eléctrico doméstico, la conexión debe realizarla un electricista profesional o bien otra persona con competencias adecuadas en el campo eléctrico.

Cuando las cargas están conectadas al generador compruebe atentamente si las conexiones eléctricas son seguras y fiables. Si la conexión no es correcta o apropiada, puede causar daños al generador o puede provocar un incendio.



¡PELIGRO!

El Generador **NO** es un cargador de baterías y no puede ser utilizado como tal ya que no está equipado con ningún sistema de control y protección de la corriente suministrada.

El uso como cargador de batería **NO ES PERMITIDO Y ES PROHIBIDO POR EL FABRICANTE.** Es peligroso y puede dañar la batería y el generador. En caso de incendio puede causar lesiones graves.

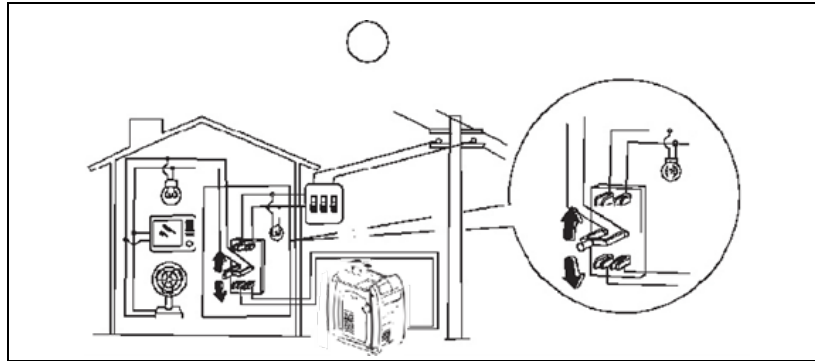
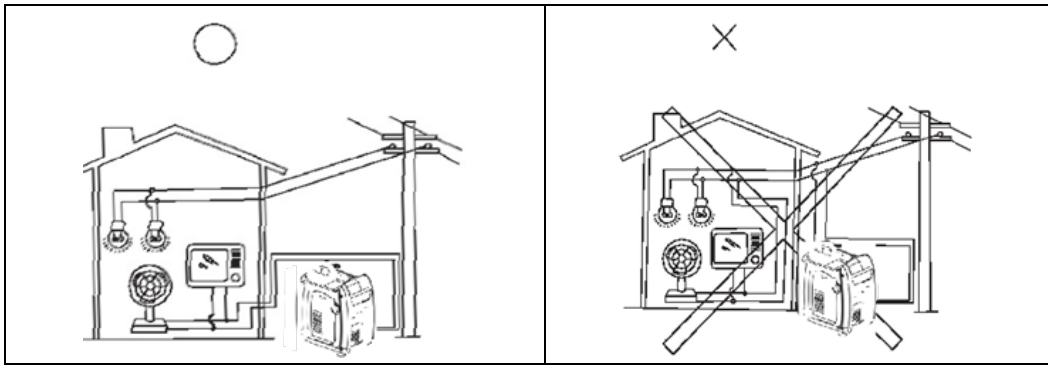

Circuito de puesta a tierra del generador

Para evitar descargas eléctricas debidas a equipos eléctricos deficitarios, o a un uso incorrecto de la electricidad, el generador debe conectarse a tierra con un conductor aislado de buena calidad.

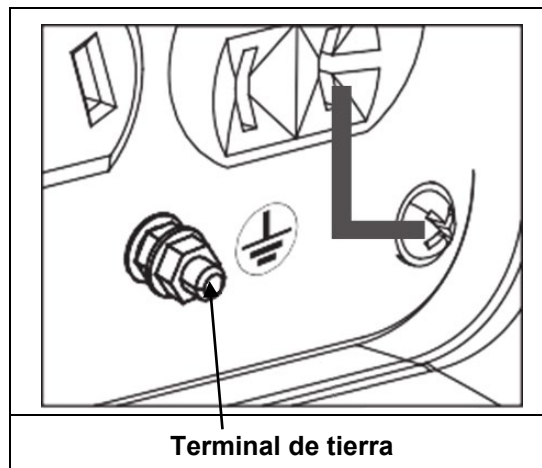

¡AVISO!

Asegúrese de que el panel de control, la salida de ventilación y el lado inferior del inversor se enfríen bien y no haya impurezas, lodo o agua. Si se bloquea la salida de enfriamiento se pueden dañar el motor, el inversor o el alternador.

No apile el generador con otros objetos encima si lo debe desplazar, almacenar o cuando está funcionando. Esto puede provocar daños al mismo generador o puede poner en peligro la seguridad del edificio si este generador tiene fugas.

2 POSICIÓN DE LAS ETIQUETAS IMPORTANTES





¡ATENCIÓN!

Lea atentamente las siguientes tablas, antes de utilizar esta máquina.

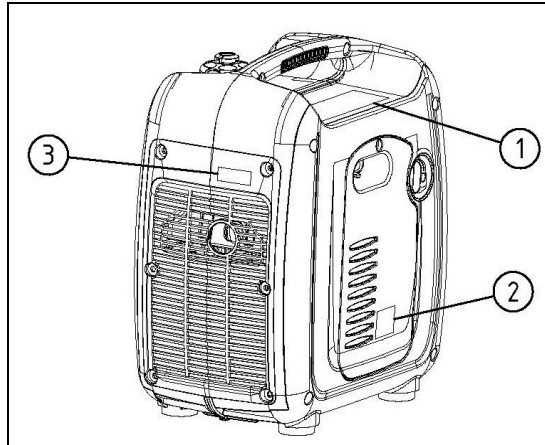
CONSEJO: Mantenga o cambie las etiquetas de las instrucciones de seguridad, si es necesario.



 WARNING	
1	<ul style="list-style-type: none">● Read the owner's manual and all labels before operating.● Only operate in well-ventilated areas. Exhaust gas contains poisonous carbon monoxide.● Check for spilled fuel or fuel leaks.● Stop engine before refueling.● Do not operate near flammable materials.● Electrocutation can occur if generator is used in rain, snow, or near water. Keep this unit dry at all times.● Electrocutation or property damage can occur. Do not connect this generator to any building's electrical system unless an isolation switch has been installed by a licensed electrician. Refer to the owner's manual.● When operating the generator:<ul style="list-style-type: none">Never place a partition or other barrier around the generator.Do not cover the generator with a box.Do not place any objects on the generator.● Turn the fuel tank cap air vent knob to "OFF" after the engine has completely cooled down.
2	
3	

3 DESCRIPCIÓN

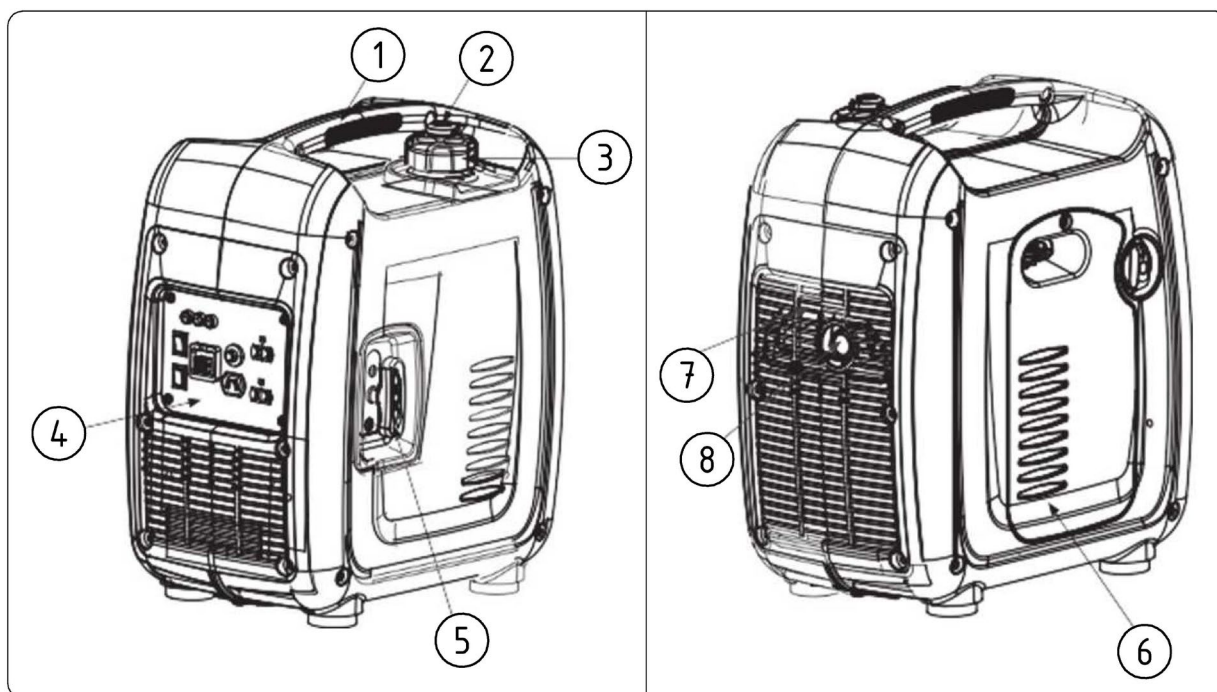

Pos.	Denominación
1	Manija para el transporte
2	Pomo de purga de aire en el tapón del depósito del combustible
3	Tapón del depósito de combustible
4	Panel de control
5	Arrancador de tirón
6	Tapón de llenado del aceite
7	Salida de ventilación
8	Silenciador

3.1 Panel de control

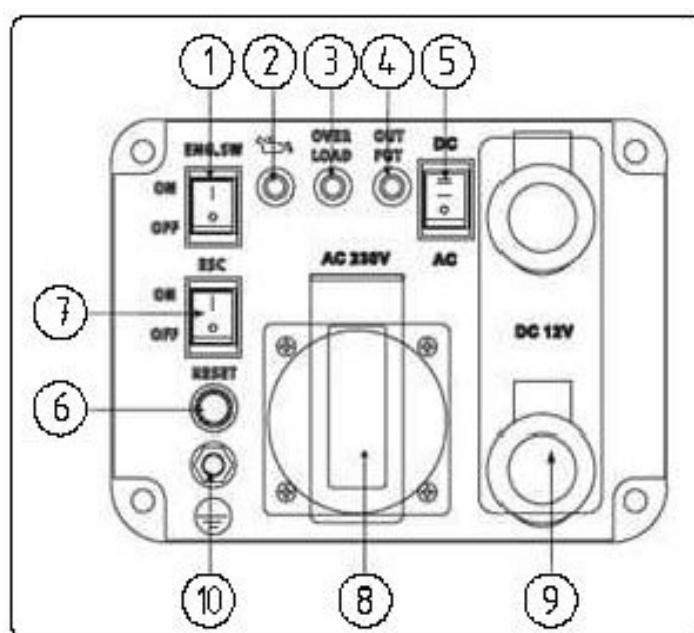

Pos.	Denominación
1	Interruptor general
2	Indicador del aceite
3	Indicador de sobrecarga
4	Indicador piloto de CA
5	Interruptor CA/CC (CA Corriente alterna, CC Corriente continua)
6	Reset de CA
7	ESC (Control inteligente del motor)
8	Toma de CA
9	Conexiones (+/-) CC
10	Terminal de tierra

4 CONTROL DE LAS FUNCIONES

4.1 Válvula de combustible

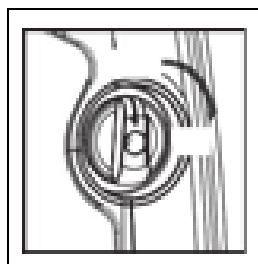

La válvula del combustible controla el flujo del combustible desde el depósito de combustible. Asegúrese de que coloca la palanca en "OFF" después de parar el motor.

4.2 Palanca de arranque

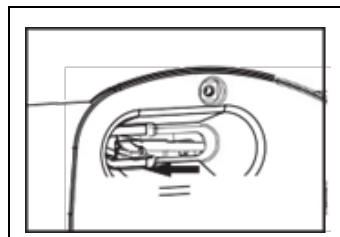

La palanca de arranque sirve para proporcionar una mezcla de combustible enriquecido, cuando se arranca el motor en frío. Coloque lentamente la palanca de arranque en la posición "ABIERTO" cuando ya se haya puesto en marcha el motor.

CONSEJO: No es necesario usar el starter para poner en marcha un motor en caliente.

4.3 Indicador de aceite (rojo)



Cuando el nivel del aceite desciende por debajo del nivel mínimo, se enciende el indicador ① y el motor se detiene automáticamente.

Si no se restablece el nivel de aceite, el motor no volverá a arrancar.

CONSEJO: Si el motor se bloquea o no arranca, coloque el interruptor del motor en "ON" y luego tire del arrancador de tirón. Si el indicador del aceite parpadea durante unos segundos, significa que el aceite del motor no es suficiente. Añada aceite y vuelva a arrancar el motor.

4.4 Indicador de sobrecarga (rojo)

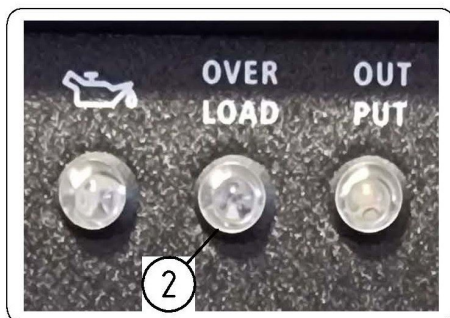

El indicador de sobrecarga ② se enciende cuando se detecta una sobrecarga de un dispositivo eléctrico conectado, la centralita del inversor se sobrecalienta, o la tensión de salida de CA aumenta. A continuación, se disparará la protección de CA, interrumpiendo la producción de energía para proteger el generador y los eventuales dispositivos eléctricos que hay conectados. El indicador del piloto de CA (verde) se apaga y el indicador de sobrecarga (rojo) se queda encendido, pero el motor no se detiene.

Cuando se enciende el indicador de sobrecarga y se detiene la producción de energía eléctrica, haga lo siguiente:

1. Apague todos los dispositivos eléctricos conectados y detenga el motor.
2. Disminuya la potencia total de los dispositivos eléctricos conectados, dentro del intervalo de la potencia nominal.
3. Controle que no haya obstrucciones en la entrada de aire de refrigeración y alrededor de la unidad de control, si se notan bloqueos, retírelos.
4. Cuando se hayan controlado, arranque de nuevo el motor.

Consejo: El indicador de sobrecarga puede encenderse durante unos segundos al empezar cuando se usan dispositivos eléctricos que necesitan una corriente de arranque muy potente, como por ejemplo, en el caso de un compresor o de una bomba de sumergible. Pero aún así, esto no indica un funcionamiento anómalo.

4.5 Indicador piloto de CA (verde)



El indicador piloto de CA ③ se enciende cuando el motor se pone en marcha y transmite potencia.

4.6 Protección de CC

4.7 Interruptor del generador

① - **On:** Arranque el generador

② - **Off:** Detenga el generador

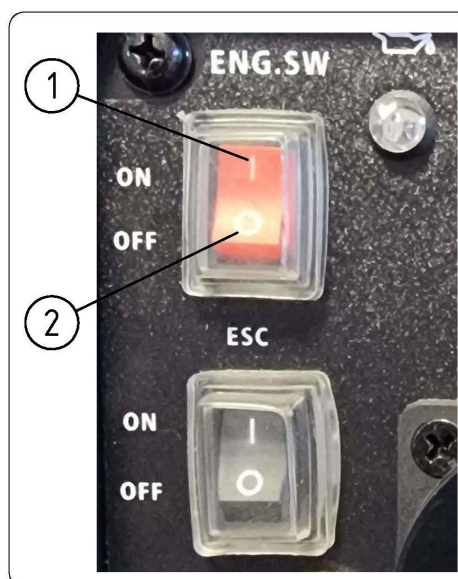

4.8 Interruptor Inteligente (C)

La función inteligente, cuando está activada (interruptor en 1 "ON"), permite que el motor funcione al ralentí con un consumo reducido de combustible en condiciones de ausencia de carga o poca carga; a medida que aumenta la carga, aumentan también las revoluciones del motor para proporcionar más potencia.

Con la función inteligente desactivada (interruptor en 0 "OFF") el motor está siempre a plena velocidad para proporcionar la máxima potencia inmediatamente; esta función es útil cuando se arrancan herramientas eléctricas con alta absorción en el arranque.



4.9 Tapón del depósito de combustible

Quite el tapón del depósito del combustible girándolo en sentido contrario a las agujas del reloj.

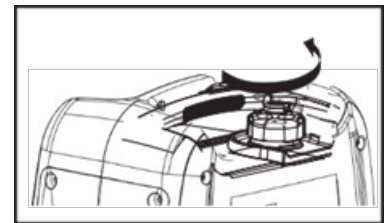

4.10 Pomo de purga de aire en el tapón del depósito del combustible

El tapón del depósito de combustible ② lleva un pomo de purga de aire para ① detener el flujo de combustible.

El pomo de purga de aire debe colocarse en "ON". Esto permitirá que el combustible fluya en el carburador y que el motor funcione.

Cuando el motor no esté en uso, gire el pomo de purga de aire a "OFF" para detener el flujo de combustible.

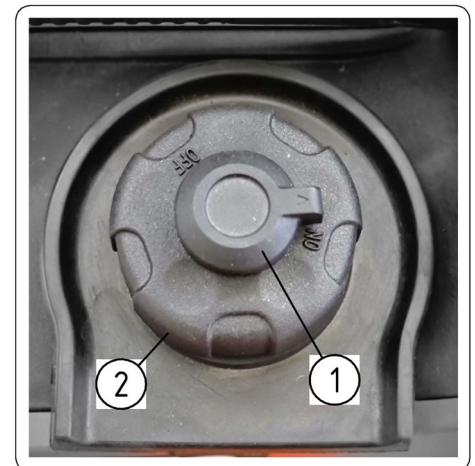

4.11 Terminal de tierra

Terminal de tierra ①



¡ATENCIÓN!

Solo debe conectarse cuando se utiliza el generador conectado a la red en corriente alterna a 220 V.



5 PREPARACIÓN

5.1 Combustible



¡ATENCIÓN!

El combustible es muy inflamable y venenoso. Lea atentamente la "INFORMACIÓN DE SEGURIDAD" antes del repostaje.

- No llene demasiado el depósito de combustible, de lo contrario, puede rebosar cuando se calienta y se expande.
- Cuando haya llenado el depósito de combustible, asegúrese de que se ha apretado bien el tapón de llenado.



¡AVISO!

- Limpie inmediatamente el combustible que se ha vertido usando un trapo suave, limpio y seco, ya que el combustible puede deteriorar las superficies pintadas o las partes de plástico.
- Use solo gasolina sin plomo. Si se usa gasolina con plomo pueden dañarse gravemente las partes internas del motor

5.2 Repostaje de combustible



¡ATENCIÓN!

El combustible es muy inflamable y venenoso. Lea atentamente la "INFORMACIÓN DE SEGURIDAD" antes del repostaje.

- No llene demasiado el depósito de combustible, de lo contrario, puede rebosar cuando se calienta y se expande.
- Cuando haya llenado el depósito de combustible, asegúrese de que se ha apretado bien el tapón de llenado



¡ATENCIÓN!

- Limpie inmediatamente el combustible que se ha vertido usando un trapo suave, limpio y seco, ya que el combustible puede deteriorar las superficies pintadas o las partes de plástico.
- Use solo gasolina sin plomo. Si se usa gasolina con plomo pueden dañarse gravemente las partes internas del motor



¡AVISO!

Para efectuar el repostaje, quite el tapón del depósito de combustible y llénelo hasta la marca roja ①.

Combustible recomendado:

Gasolina sin plomo

Capacidad del depósito de combustible:

Total: 2.5 L

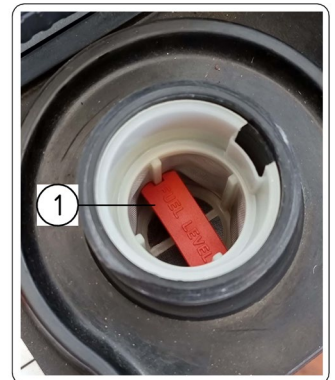

5.3 Aceite para motor



¡ATENCIÓN!

El generador se envía sin aceite para motor. No arranque el motor hasta que no se haya llenado con la cantidad suficiente de aceite para motor.



- Coloque el generador en una superficie plana.
- Quite los tornillos ①, a continuación quite la tapa ②.
- Quite el tapón de llenado del aceite ③.
- Llene con la cantidad especificada del aceite recomendado para motor, a continuación, coloque de nuevo el tapón del aceite ③.
- Monte de nuevo la tapa ②, apriete el tornillo ①.

Aceite para motor recomendado:	SAE SJ 15W-40
Grado del aceite para motor recomendado:	Tipo API Service SE o superior
Cantidad de aceite para motor:	0.31 L

5.4 COMPROBACIÓN ANTES DEL USO



¡AVISO!

- Antes de poner en marcha el generador, compruebe que está intacto en todas sus partes; si estuviera dañado, hágalo reparar antes de ponerlo en marcha, los componentes vitales pueden empezar a deteriorarse rápida e inesperadamente, incluso si el generador no se utiliza.
- El propietario es el responsable de la comprobación del estado de un generador.
- Los controles de uso previo deben realizarse cada vez que se usa el generador.
- Antes del uso, compruebe el nivel de **Combustible** (ver apart. 5.2) y si es necesario, reposte.
- Antes del uso, compruebe el nivel de **Aceite para motor** (ver apart. 5.3) y si es necesario, reposte.
- Antes del uso, controle que el generador no tenga fugas de aceite.

En caso de anomalías no descritas en este manual, diríjase a un taller autorizado.

6 FUNCIONAMIENTO



¡ATENCIÓN!

No active nunca el motor en una zona al cubierto cerrada, ya que las emisiones de gases de escape podrían causar desvanecimientos e incluso la muerte, en breve tiempo. Ponga en marcha el motor en una zona con buena ventilación.

- Antes de que el generador haya arrancado, no conecte ningún dispositivo eléctrico.
- El generador se entrega sin aceite para motor; no ponga en marcha el motor hasta que se haya llenado con la cantidad indicada (ver apart. 5.3).
- No incline el generador cuando añada aceite para motor, esto podría causar un llenado excesivo y dañar el motor.
- El generador debe usarse con la carga nominal en salida, en condiciones atmosféricas estándar:
 - Temperatura ambiente: 25 °C
 - Presión barométrica: 100 kPa
 - Humedad relativa: 30%.
- La potencia del generador cambia en base a los cambios de temperatura, de altitud (presión del aire más baja en alta cota) y de humedad.
- La potencia del generador se reduce cuando la temperatura, la humedad y la altitud superan las condiciones atmosféricas estándar.
- La carga tendrá que reducirse cuando se utiliza en espacios reducidos, ya que la refrigeración del generador se ve afectada.

6.1 Arranque del motor

- 1- Coloque el pomo de purga en "On" ①

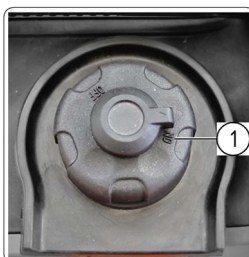

- 2- Gire el grifo del combustible ② en posición A
- 3- Lleve la palanca de la leva del Starter ③ a la posición B.

El generador está listo para arrancarlo.



⚠ ¡AVISO!

Para arrancar el generador con el motor caliente, la palanca del starter tiene que permanecer en la posición "OPEN".

- 4- Tire lentamente de la manija ② del arrancador de retroceso hasta que se acople, luego tire rápidamente para arrancar el motor.



⚠ ¡ATENCIÓN!

Agarre firmemente la manija de transporte ① para evitar que el generador se caiga cuando se tire del arrancador de retroceso.

- 5- Después de algunos minutos de funcionamiento del motor, vuelva a colocar la palanca del starter en posición OPEN.

6.2 Parada del motor

⚠ ¡AVISO!

- Antes de parar el motor del generador, apague todos los dispositivos eléctricos conectados.
- Lleve el interruptor del generador a la posición "OFF" (ver apart. 4.7).
- Gire el grifo del combustible en posición "0" CLOSE.

El circuito de encendido está apagado, el combustible está cerrado.



- Después de que el motor se haya enfriado completamente, gire el pomo de purga del aire hacia "OFF" - 1.



6.3 Conexión en corriente alterna (CA)

⚠ ¡ATENCIÓN!

- Asegúrese de que todos los dispositivos eléctricos estén apagados antes de conectarlos al generador.
- Asegúrese de que todos los dispositivos eléctricos, incluidos los cables y los conectores de enchufe, estén en buen estado antes de conectarlos al generador.
- Asegúrese de que la carga total esté dentro de la potencia nominal del generador.
- Asegúrese de que la corriente de carga de la toma esté dentro de la corriente nominal de la toma.

NOTA: si el generador está conectado a la red en corriente alterna de 220 V, también el generador tiene que estar conectado a tierra a través del terminal de tierra (ver apart. 4.11).



⚠ ¡ATENCIÓN!

Cuando se utilizan herramientas de 12 V, el interruptor inteligente "ESC" (véase el apart. 4.8) tiene que estar absolutamente en la posición 1 "ON").

6.4 Campo de aplicación

⚠ ¡ATENCIÓN!

Cuando se utilice el generador, asegúrese de que la carga total esté dentro de la potencia nominal del generador. En caso contrario, se puede dañar el generador.

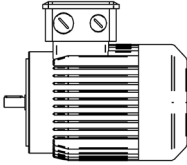
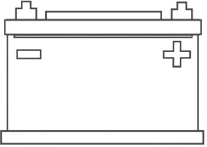
				
CA				CC
Factor de potencia	1	0.8- 0.95	0.4-0.75 (Eficiencia 0,85)	
kW	≤ 1000 W	≤ 800 W	≤ 400 W	Tensión nominal 12 V

⚠ ¡ATENCIÓN!

- La potencia de la aplicación indica cuando cada dispositivo se utiliza solo.

EJEMPLO:

Potencia nominal de salida del generador		1.000 W
Frecuencia	Factor de potencia	
CA	1,0	≤ 1.000 W
	0,8	≤ 800 W
CC	---	700 W (12 Vx58.3 A)

⚠ ¡ATENCIÓN!

El indicador de sobrecarga ② se enciende cuando la potencia total supera los datos de la placa (ver cap. 10).



⚠ ¡ATENCIÓN!

- No sobrecargue, la carga total de todos los aparatos eléctricos conectados no debe superar los datos de la placa del generador. Una sobrecarga daña el generador.
- Cuando se alimenten equipos de precisión, controladores electrónicos, PC, equipos ordenadores electrónicos, equipos basados en micro ordenadores o cargadores de baterías, mantenga el generador a una distancia suficiente para evitar interferencias eléctricas. Asegúrese también de que las frecuencias emitidas por el generador no interfieren con otros dispositivos eléctricos y electrónicos situados cerca del mismo.
- Si el generador tiene que alimentar equipos médicos, antes es necesario consultar al fabricante o a un profesional médico.
- Algunos aparatos eléctricos o motores eléctricos en general tienen corrientes de arranque elevadas y, por tanto, no pueden utilizarse, aunque estén dentro de los intervalos de alimentación indicados en la tabla anterior. Consulte al fabricante del equipo para más consejos.

7 MANTENIMIENTO

¡ATENCIÓN!

- Antes de efectuar cualquier operación de mantenimiento ordinario, apague el generador.
- Todas las operaciones de mantenimiento no previstas en este manual deben ser realizadas en los centros de asistencia autorizados.



Las operaciones de mantenimiento ordinario pueden ser realizadas por los operadores.

¡ATENCIÓN!

- El motor debe someterse a un mantenimiento adecuado para garantizar un funcionamiento seguro, económico, sin problemas y respetuoso con el medio ambiente. Para mantener el motor de gasolina en buen estado de funcionamiento, debe efectuarse un mantenimiento regularmente. Es necesario efectuar atentamente el siguiente programa de mantenimiento y los procedimientos rutinarios de inspección:

Componente	Frecuencia	Siempre	Primer mes o primeras 20 horas de funcionamiento	A continuación, cada 3 meses o cada 50 horas de funcionamiento	Cada año o cada 100 horas de funcionamiento
	Aceite para motor	Control - Recarga	✓		
Sustitución			✓	✓	
Filtro del aire	Control	✓			
	Limpieza		✓		
	Sustitución			✓	
Bujía de encendido	Control - regulación				✓
	Sustitución	Cada año o cada 250 horas de funcionamiento			
Salvachispas	Limpieza				
Funcionamiento al mínimo (si está suministrado) *	Control - regulación				✓
Depósito y filtro de combustible *	Limpieza				✓
Tubo de combustible	Control	Cada 2 años (cambiar si es necesario)			

* Estos componentes deben ser mantenidos y reparados por nuestro distribuidor autorizado.

¡ATENCIÓN!

Pare el motor antes de realizar el mantenimiento. Coloque el motor en una superficie plana y quite el capuchón de la bujía para impedir el arranque del motor.

No accione el motor en un ambiente poco ventilado o en otra zona cerrada. Asegúrese de mantener una buena ventilación en el área de trabajo. La salida de escape del motor puede contener CO venenoso; la inhalación puede provocar un shock, pérdida de conciencia e incluso la muerte

¡ATENCIÓN!

- Si el motor de gasolina funciona a menudo a temperaturas elevadas o con cargas pesadas, cambie el aceite cada 25 horas.
- Si el motor funciona frecuentemente en condiciones de polvo o en otras circunstancias graves, limpie el elemento filtrante del aire cada 10 horas. Si es necesario, sustituya el elemento filtrante del aire cada 25 horas.
- Respete los periodos de mantenimiento indicados.
- Si el plazo previsto para el mantenimiento del motor no se ha respetado, actúe lo antes posible.



TALLER AUTORIZADO

Es el taller indicado por nuestros distribuidores, autorizado a llevar a cabo operaciones de reparación de los productos.

7.1 Inspección de la bujía



¡ATENCIÓN!

La bujía es un componente importante del motor y debe ser controlada periódicamente.

1. Retire la tapa ①, extraiga el tapón de la bujía ②; utilizando la llave suministrada en el generador, desenrosque la bujía girando en sentido contrario a las agujas del reloj.
2. Compruebe que no haya residuos carbonosos, si hubiera elimínelos con un cepillo de acero.
3. Compruebe que la bujía corresponda con el modelo indicado: bujía estándar **A5RTC**

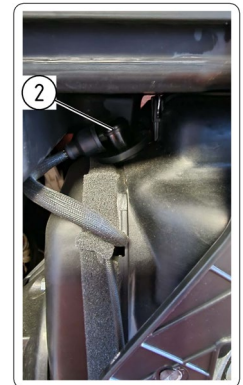

4. Con la ayuda de un espesímetro, compruebe la distancia entre los electrodos: 0,6-0,8 mm.
5. Vuelva a montar la bujía con un par de apriete de 12,5 Nm
6. Vuelva a montar el tapón de la bujía ② y la tapa ①.

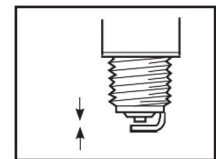

7.2 Ajuste del carburador



¡ATENCIÓN!

El carburador es un componente importante del motor, su mantenimiento y ajuste debe ser realizado por un centro de asistencia autorizado.

7.3 Sustitución del aceite para motor



¡ATENCIÓN!

- Evite descargar el aceite para motor inmediatamente después de la parada del motor. El aceite está caliente y debe ser manipulado con atención para evitar quemaduras.
- Para su sustitución, consulte el Parágrafo 5.3.



¡ATENCIÓN!

No incline el generador cuando se añade aceite al motor. Esto podría causar un llenado excesivo y daños al motor.

7.4 Filtro del aire

- Coloque el generador en una superficie plana.
- Quite el tornillo ①, y a continuación quite la tapa ②.
- Quite la tapa del filtro ③.
- Quite el filtro ③.
- Limpie el elemento de esponja con detergente neutro y séquelo.
- Engrase el elemento de esponja y elimine el aceite en exceso. El elemento de esponja debe estar humedecido pero sin gotear.

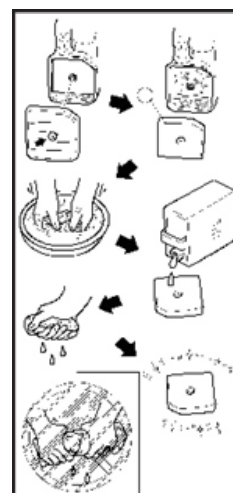

¡ATENCIÓN!

No exprima el elemento de esponja durante esta operación. Puede romperse.

- Introduzca el elemento de esponja en el cuerpo del filtro de aire, asegurándose de que la superficie de sellado del elemento de esponja se adhiera al filtro del aire para que no haya fugas de aire.



¡ATENCIÓN!

El motor no debe funcionar nunca sin el elemento de esponja; puede producirse un desgaste excesivo del pistón y del cilindro.

- Vuelva a montar la tapa del cuerpo del filtro ③ del aire en su posición original.
- Vuelva a montar la tapa ② y apriete el tornillo ①.

7.5 Pantalla del silenciador y salvachispas

⚠ ¡ATENCIÓN!

El motor y el silenciador estarán muy calientes después del funcionamiento del motor. Evite tocar el motor y el silenciador cuando todavía estén calientes con cualquier parte del cuerpo o indumentaria durante la inspección o reparación.

- Quite los tornillos ①, retire la tapa ②.
- Afloje el perno ③, retire la abrazadera metálica del silenciador ④.
- Quite el capuchón del silenciador ⑤.
- Limpie los depósitos de carbono que hay en el silenciador con un cepillo metálico.

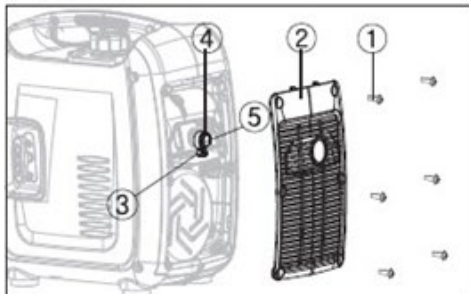

⚠ ¡ATENCIÓN!

Durante la limpieza, utilice delicadamente el cepillo metálico para evitar que se dañe el silenciador.

- Si el silenciador está dañado, sustitúyalo.
- Vuelva a montar el silenciador ⑤, la abrazadera metálica ④, la tapa ② y los tornillos ①.

7.6 Filtro del depósito de combustible

⚠ ¡ATENCIÓN!

No utilice nunca la gasolina cuando fume o esté cerca de una llama libre.

- Retire el tapón del depósito de combustible y el filtro.
- Limpie el filtro con gasolina y vuelva a montarlo.
- Cierre de nuevo el tapón del depósito de combustible.

⚠ ¡ATENCIÓN!

Asegúrese de que el tapón del depósito de combustible esté bien cerrado.

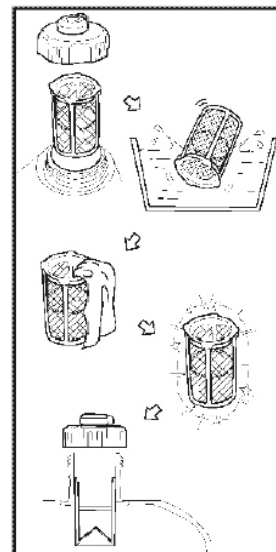

8 CONSERVACIÓN



¡AVISO!

Si la máquina se pone en reposo durante un período prolongado, serán necesarios algunos procedimientos preventivos para protegerla del deterioro.

8.1 Vaciado del combustible

- Gire el grifo del combustible en posición "0" **CLOSE**.
- Retire el tapón del depósito de combustible y el filtro. Retire el combustible del depósito vertiéndolo en un recipiente de gasolina homologado. A continuación, vuelva a colocar el tapón del depósito de combustible.



¡ATENCIÓN!

El combustible es altamente inflamable y venenoso, limpie inmediatamente el combustible que se ha vertido usando un trapo suave, limpio y seco, ya que el combustible puede deteriorar las superficies pintadas o las partes de plástico.



¡AVISO!

Arranque el motor y déjelo funcionar hasta que se agote el combustible residual; no conecte dispositivos eléctricos, esta operación debe realizarse en vacío. La duración del funcionamiento en vacío depende del combustible residual en el depósito.



¡AVISO!

Limpie el exterior del generador, consérvelo en un lugar seco, bien ventilado y protegido.

9 SOLUCIÓN DE PROBLEMAS



¡ATENCIÓN!

Todas las operaciones de mantenimiento extraordinario deben ser realizadas por un encargado de mantenimiento mecánico.

AVERÍA	CAUSA	SOLUCIÓN
El motor no arranca.	- Combustible ausente en el depósito. - Combustible presente en el depósito.	- Llene el depósito de combustible. - Compruebe la posición de la válvula de escape en el tapón del depósito (ver apart. 4.9) Verifique la posición del grifo del combustible (ver apart. 4.1).
	Carburador obstruido.	Lleve el generador a un centro de asistencia autorizado por el Fabricante.
Nivel bajo del aceite del motor (se enciende el indicador luminoso)	Falta aceite.	Ponga el aceite en el motor (ver apart. 5.2).
Mal funcionamiento eléctrico/mecánico.	- Bujía sucia o mojada. - Sistema de encendido defectuoso.	- Vuelva a limpiar y seque la bujía (ver apart. 7.1). - Lleve el generador a un centro de asistencia autorizado por el Fabricante.
El generador no produce energía.	- Dispositivo de seguridad (protección CC) en "OFF". - El indicador piloto de CA (verde) se apaga.	- Lleve la protección CC a "ON". - Apague el motor, luego vuelva a arrancarlo.

10 ESPECIFICACIONES TÉCNICAS

Modelo		1 kW
Generador	Tipo	Inversor silenciado
	Frecuencia nominal (Hz)	50/60
	Tensión nominal (V)	110/120/220/230/240
	Potencia de salida nominal (kW)	1,0
	Factor de potencia	1
	Capacidad del depósito de combustible (L)	2,5
	Calidad de la salida CA	ISO8528 G2
	Tensión de carga (CC) (V)	12
	Corriente de carga (CC) (A)	58.3
	Potencia (CC) (W)	700
	Protección por sobrecarga (CC)	Protección sin fusibles
Motor	Motor	R60-i
	Tipo de motor	Monocilíndrico, 4 tiempos, enfriamiento por aire forzado, OHV
	Cilindrada (cc)	60
	Tipo de combustible	Gasolina sin plomo
	Tiempo de funcionamiento continuo (a la potencia nominal) (h)	4
	Capacidad del aceite (L)	0,31
	N.º modelo de la bujía	ASRTC
	Modalidad de arranque	Arrancador de retroceso
Generador	Longitud x anchura x altura (mm)	380×240×420
	Peso neto (kg)	13

11 DESGUACE Y ELIMINACIÓN DE LOS COMPONENTES

11.1 Eliminación de los materiales usados

Después de la instalación y durante su funcionamiento normal, la máquina no produce contaminación ambiental, pero durante todo el período de uso se producen algunos materiales de desecho en condiciones particulares (por ejemplo, la grasa de lubricación de las partes mecánicas).

Para la eliminación de dichos materiales, en cada país existen normativas específicas para la protección del medio ambiente. Es obligación del Cliente conocer las leyes aplicables vigentes en su país y actuar cumpliendo con tales leyes, en conformidad con las indicaciones que figuran en las fichas técnicas de los productos utilizados, que pueden solicitarse al Fabricante.



¡ATENCIÓN!

Se recuerda que deben respetarse las leyes vigentes correspondientes a la eliminación de aceites minerales o de las grasas utilizadas para la lubricación/mantenimiento.



¡ATENCIÓN!

Para obtener más información sobre los modos de eliminación de aceites y otras sustancias, consulte la ficha de seguridad de las sustancias en cuestión.

La eliminación de residuos tóxicos en las fases de recogida, transporte, tratamiento (entendido como operación de transformación necesaria para la recuperación), así como el depósito y la descarga en el suelo son actividades de interés público, sometidas al cumplimiento de los siguientes principios generales:

- a) Debe evitarse cualquier daño o peligro para la salud, la incolumidad y la seguridad de la colectividad y de los individuos.
- b) Debe garantizarse el respeto de los requisitos higiénico-sanitarios y evitarse cualquier riesgo de contaminación del aire, del agua, del suelo y del subsuelo.

Deben promoverse, con el cumplimiento de criterios económicos y eficientes, los sistemas de recuperación y reciclado de materiales y energía.

11.2 Indicaciones para los residuos especiales

Los residuos especiales son los residuos resultantes de los procesos industriales y los materiales procedentes de los desguaces de equipos y máquinas deterioradas y obsoletas.

Los productores de residuos especiales, incluso tóxicos y nocivos, deben encargarse de su eliminación, directamente o a través de empresas u organismos autorizados, o entregándolos a los sujetos que gestionan el servicio público, con los cuales se haya estipulado un acuerdo específico.

Todos los municipios tienen la obligación de proporcionar a la Comunidad Autónoma todas las informaciones disponibles sobre la eliminación de residuos en su territorio.



¡ATENCIÓN!

La eliminación abusiva del producto por parte del poseedor implica la aplicación de las sanciones administrativas previstas por las normativas vigentes.



¡ATENCIÓN!

Según la Directiva «RAEE» 2012/19/UE, si el componente/equipo comprado está marcado con el siguiente símbolo de contenedor con ruedas tachado, significa que el producto al final de su vida útil debe recogerse por separado de otros residuos.

La recogida selectiva del presente componente/producto, al final de su vida útil, será organizada y gestionada por el Fabricante. Por lo tanto, el usuario que desee deshacerse de este equipo debe ponerse en contacto con el fabricante y seguir el sistema que ha adoptado para permitir la recogida por separado del equipo al final de su vida útil. La adecuada recogida selectiva para la puesta en marcha posterior de los equipos descargados para reciclaje, tratamiento y eliminación medioambiental compatible contribuye a evitar posibles efectos negativos sobre el medio ambiente y la salud y favorece la reutilización y/o el reciclaje de los materiales de los que está compuesto la herramienta. La eliminación abusiva del producto por parte del usuario implica la aplicación de las sanciones previstas por las leyes locales vigentes.



Agradecemos por ter escolhido um Gerador RATO por Campagnola.

Este manual contém as informações sobre como utilizá-lo. Solicitamos que seja efetuada uma leitura atenta antes do uso. Operar de maneira segura e correta possibilitará a obtenção dos melhores resultados.

Todas as informações contidas nesta publicação baseiam-se nas informações sobre os produtos mais recentes disponíveis no momento da impressão. O conteúdo deste manual pode diferir das partes efetivas devido a revisões e outras alterações.

A nossa empresa reserva-se o direito de efetuar alterações em qualquer momento, sem o prévio aviso e sem incorrer em qualquer obrigação. Nenhuma parte desta publicação poderá ser reproduzida sem a autorização escrita da nossa empresa.

Este manual deve ser considerado como parte permanente do Gerador e deve acompanhar o Gerador em caso de revenda.

ADVERTÊNCIAS SOBRE A SEGURANÇA

AVISO!

A segurança pessoal e a segurança da sua propriedade e de terceiros são muito importantes. Solicita-se que seja realizada a leitura atenta das mensagens precedidas pelo símbolo.

PERIGO!

Subsiste o risco de MORTE ou de LESÕES graves caso não sejam respeitadas as instruções.

ADVERTÊNCIA!

Subsiste o perigo de MORTE ou de LESÕES graves caso não sejam respeitadas as instruções.

ATENÇÃO!

Subsiste o perigo de LESÕES graves caso não sejam respeitadas as instruções.

AVISO!

O Gerador ou outros bens podem ser danificados em caso de inobservância das instruções.

SUMÁRIO

ADVERTÊNCIAS SOBRE A SEGURANÇA.....	80
1 INDICAÇÕES DE SEGURANÇA	82
2 POSIÇÃO DAS ETIQUETAS IMPORTANTES	84
3 DESCRIÇÃO.....	85
3.1 Painel de controlo	85
4 CONTROLO DAS FUNÇÕES	86
4.1 Válvula do combustível	86
4.2 Alavanca de arranque	86
4.3 Indicador óleo (vermelho)	86
4.4 Indicador de sobrecarga (vermelho).....	87
4.5 Indicador piloto AC (verde)	87
4.6 Proteção DC.....	87
4.7 Interruptor Geral.....	87
4.8 Interruptor Inteligente (C).....	88
4.9 Tampa do tanque de combustível	88
4.10 Manípulo de escape de ar na tampa do tanque de combustível.....	88
4.11 Terminal de aterramento.....	88
5 PREPARAÇÃO.....	89
5.1 Combustível	89
5.2 Abastecimento Combustível	89
5.3 Óleo motor	89
5.4 VERIFICAR ANTES DO USO.....	90
6 FUNCIONAMENTO	90
6.1 Arranque do motor	90
6.2 Arranque do motor	91
6.3 Ligação em corrente alternada (AC).....	91
6.4 Campo de aplicação	92
7 MANUTENÇÃO	93
7.1 Inspeção da vela	94
7.2 Regulação carburador	94
7.3 Substituição do óleo do motor	94
7.4 Filtro de ar	94
7.5 Blindagem do silenciador e do protetor de faíscas.....	95
7.6 Filtro do tanque de combustível.....	95
8 CONSERVAÇÃO.....	96
8.1 Descarga do combustível	96
9 RESOLUÇÃO DOS PROBLEMAS	96
10 ESPECIFICAÇÕES TÉCNICAS	97
11 DESMANTELAMENTO E ELIMINAÇÃO DOS COMPONENTES.....	97
11.1 Eliminação dos materiais gastos	97
11.2 Indicações relativas aos resíduos especiais.....	98

1 INDICAÇÕES DE SEGURANÇA

Ler e compreender este manual de uso antes de colocar o Gerador em funcionamento. O conhecimento dos procedimentos de funcionamento seguro do Gerador irá ajudá-lo a evitar possíveis acidentes.

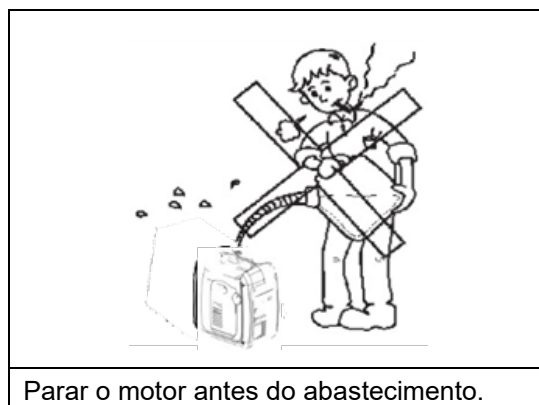
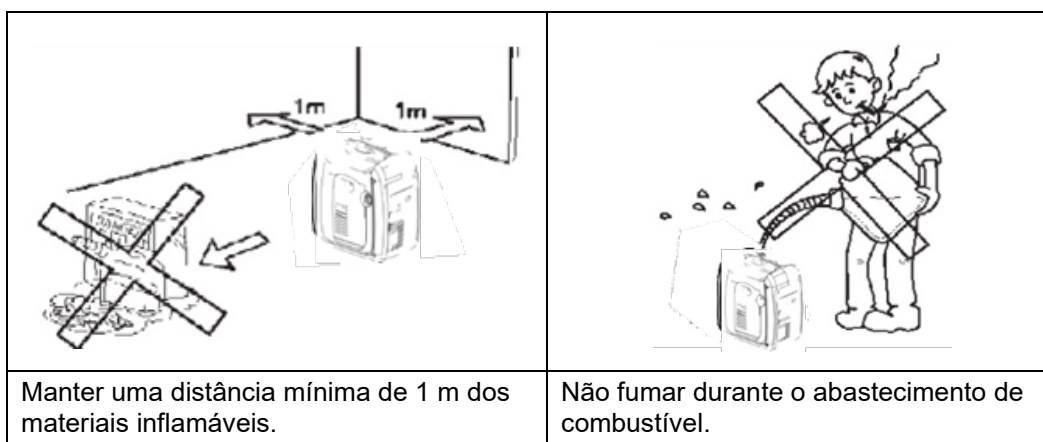

AVISO!

Ligação à alimentação elétrica doméstica.

Caso o Gerador precise ser ligado à alimentação elétrica doméstica, a ligação deve ser efetuada por um electricista profissional ou por outra pessoa com competências elétricas apropriadas.

Quando as cargas são conectadas ao Gerador, verificar atentamente se as ligações elétricas são seguras e fiáveis. Uma ligação inadequada poderá provocar danos ao Gerador ou incêndio.



PERIGO!

O Gerador **NÃO** é um carregador de bateria e não pode ser usado para isso, pois não está equipado com nenhum sistema de controle e proteção para a corrente fornecida.

O uso como carregador de bateria **NÃO É PERMITIDO E PROIBIDO PELO FABRICANTE**, é perigoso e pode danificar a bateria, o gerador, em caso de incêndio pode causar ferimentos graves.

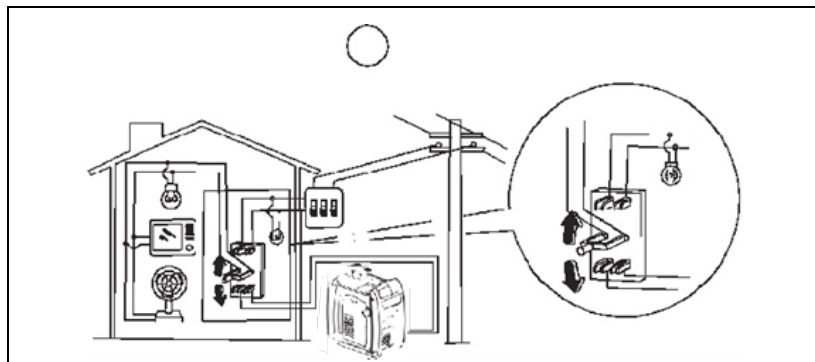
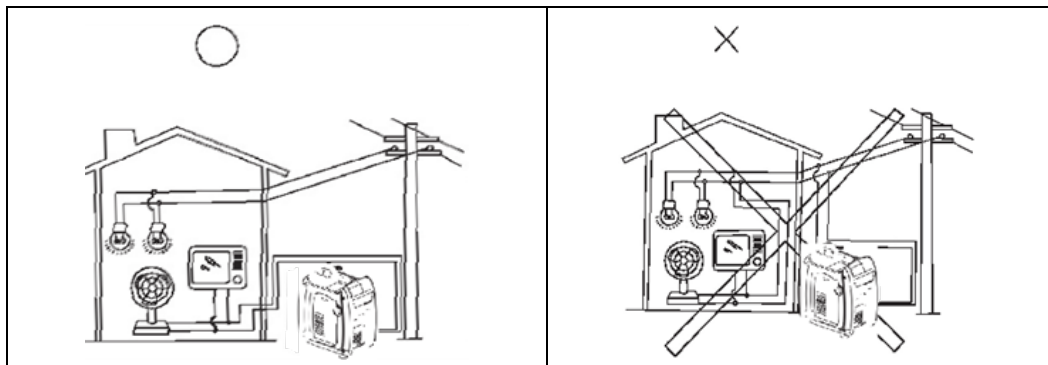

Circuito de aterramento do Gerador

Para evitar choques elétricos provocados por equipamentos elétricos de péssima qualidade ou pelo uso errado da eletricidade, o Gerador deve ser aterrado com um condutor isolado de boa qualidade.

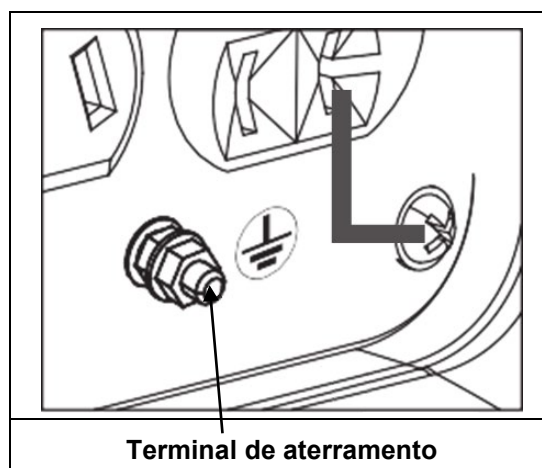

AVISO!

Certificar-se de que o painel de controle, a tomada de ar e o lado inferior do inversor arrefeçam e que não estejam presentes impurezas, lodo e água. Em caso de bloqueio da ventilação de arrefecimento, poderá ocorrer um dano ao motor, ao inversor ou ao alternador.

Não empilhar o Gerador com outros objetos em caso de deslocamento, desativação ou funcionamento da unidade. Isso poderá provocar danos ao Gerador e comprometer a segurança da propriedade caso o Gerador apresente vazamentos.



2 POSIÇÃO DAS ETIQUETAS IMPORTANTES

ATENÇÃO!

Ler atentamente as seguintes tabelas antes de utilizar esta máquina.

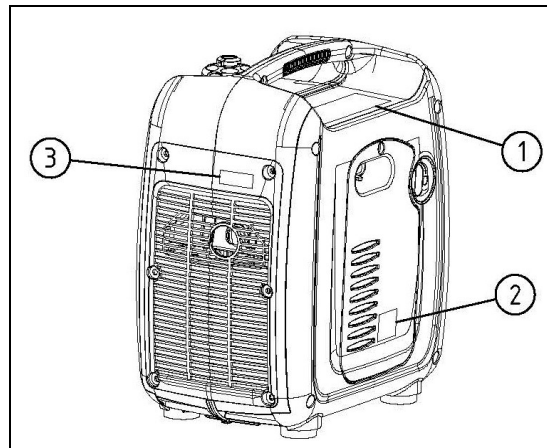
CONSELHO: Manter ou substituir as etiquetas de instrução e segurança, caso seja necessário.



 WARNING	
①	<ul style="list-style-type: none">● Read the owner's manual and all labels before operating.● Only operate in well-ventilated areas. Exhaust gas contains poisonous carbon monoxide.● Check for spilled fuel or fuel leaks.● Stop engine before refueling.● Do not operate near flammable materials.● Electrocutation can occur if generator is used in rain, snow, or near water. Keep this unit dry at all times.● Electrocutation or property damage can occur. Do not connect this generator to any building's electrical system unless an isolation switch has been installed by a licensed electrician. Refer to the owner's manual.● When operating the generator:<ul style="list-style-type: none">Never place a partition or other barrier around the generator.Do not cover the generator with a box.Do not place any objects on the generator.● Turn the fuel tank cap air vent knob to "OFF" after the engine has completely cooled down.
②	
③	

3 DESCRIÇÃO

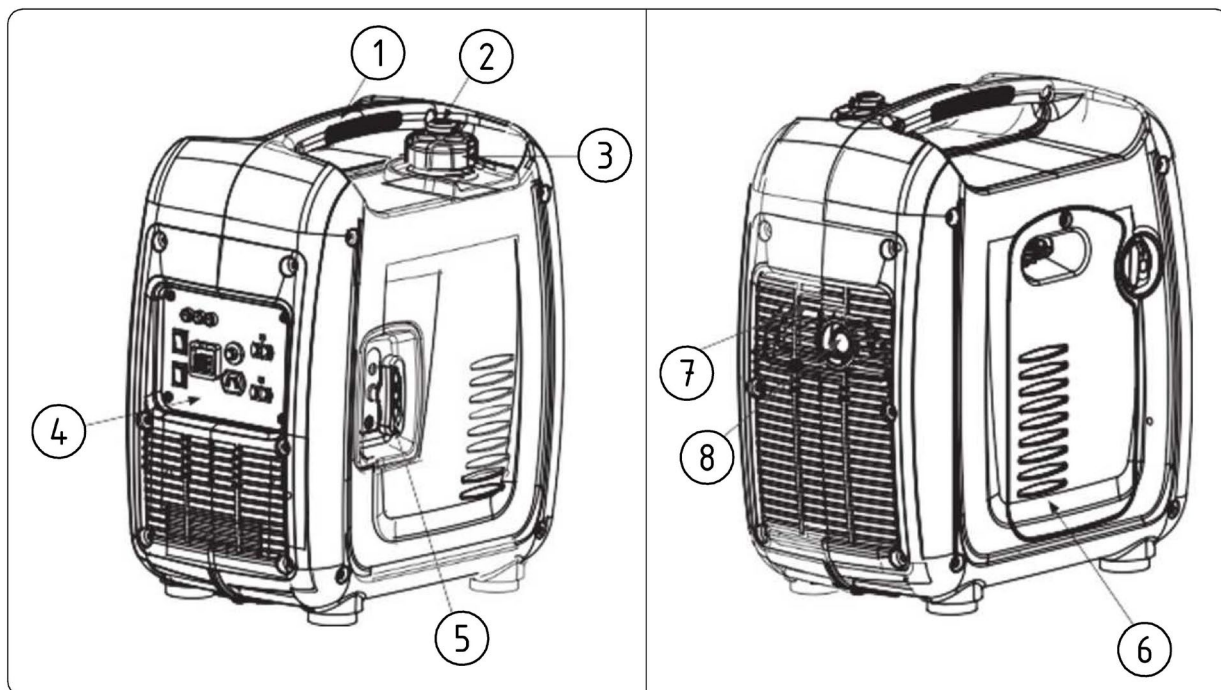

Pos.	Denominação
1	Pega de transporte
2	Manípulo de escape de ar na tampa do tanque de combustível
3	Tampa do tanque de combustível
4	Painel de controlo
5	Arranque por enrolamento
6	Tampa de abastecimento de óleo
7	Tomada de ar
8	Silenciador

3.1 Painel de controlo

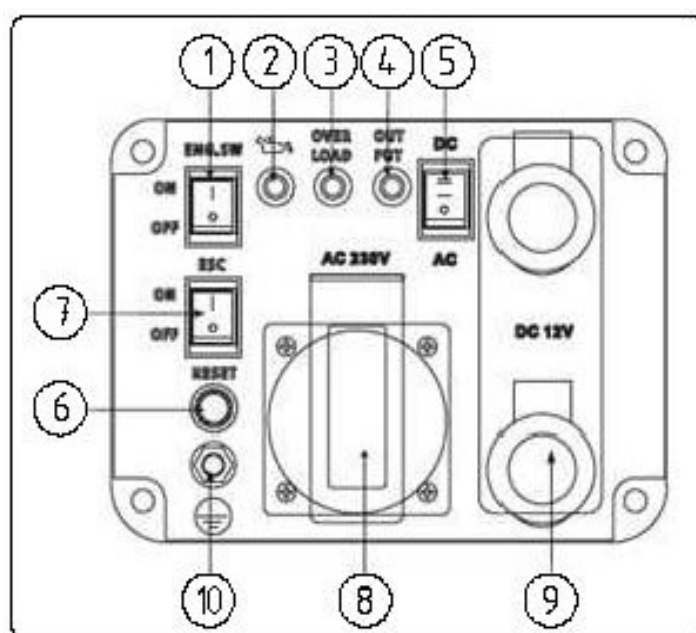

Pos.	Denominação
1	Interruptor Geral
2	Indicador do óleo
3	Indicador de Sobrecarga
4	Indicador piloto AC
5	Interruptor AC/DC (AC Corrente alternada, DC Corrente contínua)
6	AC Reset
7	ESC (Controlo inteligente do motor)
8	Tomada AC
9	Conexões (+/-) DC
10	Terminal de aterramento

4 CONTROLO DAS FUNÇÕES

4.1 Válvula do combustível

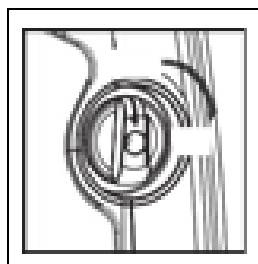

A válvula do combustível controla o fluxo de combustível do tanque ao carburador. Certificar-se de deixar a alavanca em «OFF» após a paragem do motor.

4.2 Alavanca de arranque

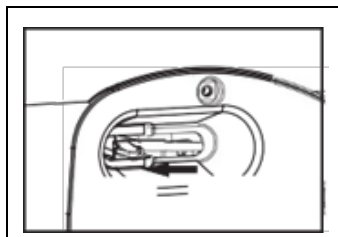

A alavanca de arranque serve para fornecer uma mistura de combustível enriquecido quando efetua-se o arranque de um motor frio. Colocar lentamente a alavanca de arranque na posição "ABERTO" após efetuar o arranque do motor.

CONSELHO: O arrancador não é necessário para efetuar o arranque de um motor quente.

4.3 Indicador óleo (vermelho)



Quando o nível do óleo ficar abaixo do mínimo, acenderá o indicador ① e o motor irá parar automaticamente. Caso não seja restabelecido o nível do óleo, o motor não irá arrancar.

CONSELHO: Caso o motor fique bloqueado ou não efetue o arranque, posicionar o interruptor do motor em "ON" e efetuar o arranque com puxão. Caso o indicador do óleo apresente intermitência por alguns segundos, significa que o óleo do motor é insuficiente. Acrescentar óleo e efetuar o arranque novamente.

4.4 Indicador de sobrecarga (vermelho)

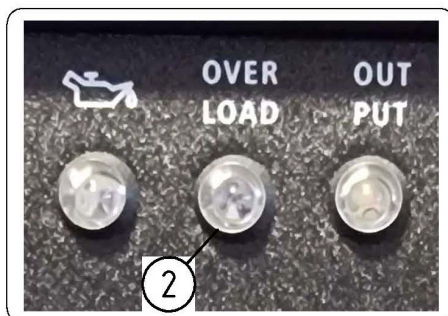

O indicador de sobrecarga ② acende quando é detectada a sobrecarga de um dispositivo elétrico ligado, a central do inversor se sobreaquece ou a tensão de saída AC aumenta. Então, a proteção AC será ativada, interrompendo a geração de energia para proteger o Gerador e os eventuais dispositivos elétricos ligados. O indicador piloto AC (verde) desliga e o indicador de sobrecarga (vermelho) permanece aceso, mas o motor não para.

Quando acende o indicador de sobrecarga e a produção de energia elétrica para, proceder da seguinte maneira:

1. Desligar todos os dispositivos elétricos conectados e parar o motor.
2. Reduzir a potência total dos dispositivos elétricos ligados dentro do intervalo da potência nominal.
3. Verificar se não há obstruções na entrada de ar de arrefecimento e em torno da unidade de controlo, caso se verifiquem obstruções, removê-las.
4. Após efetuar o controlo, efetuar o arranque do motor.

Conselho: O indicador de sobrecarga pode acender por alguns segundos no início, quando são utilizados dispositivos elétricos que requerem uma grande corrente de arranque, como por exemplo um compressor ou uma bomba de imersão. Todavia, não se trata de um mau funcionamento.

4.5 Indicador piloto AC (verde)

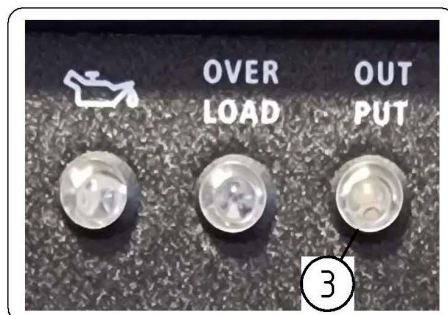

O indicador piloto AC ③ acende quando o motor arranca e produz potência.

4.6 Proteção DC

4.7 Interruptor Geral

① - **On:** Efetuar o arranque do Gerador

② - **Off:** Parar Gerador

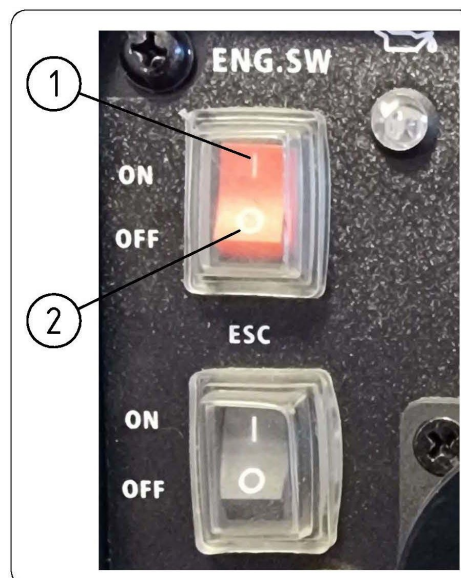

4.8 Interruptor Inteligente (C)

A função inteligente, se ativada (interruptor em 1 "ON"), permite que o motor funcione no mínimo, com um consumo de combustível reduzido, em condições de ausência ou pouca carga; ao aumentar a carga, aumentam também as rotações do motor, para fornecer mais potência.

Com a função inteligente desativada (interruptor em 0 "OFF"), o motor permanece sempre a funcionar com a rotação máxima, para fornecer imediatamente a máxima potência. Esta função é útil quando deve efetuar o arranque das ferramentas elétricas com grandes absorções no arranque.

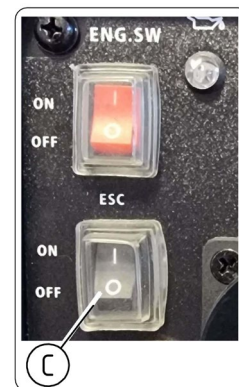

4.9 Tampa do tanque de combustível

Remover a tampa do tanque do combustível girando-o em sentido anti-horário.

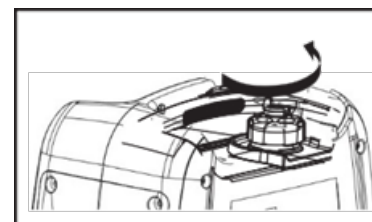

4.10 Manípulo de escape de ar na tampa do tanque de combustível

A tampa do tanque do combustível ② possui um manípulo de escape de ar para ① parar o fluxo de combustível.

O manípulo de escape de ar deve estar posicionado em "ON". Isso permitirá que o combustível flua para o carburador e que o motor funcione.

Quando o motor não é usado, girar o manípulo de escape de ar em "OFF" para parar o fluxo de combustível.

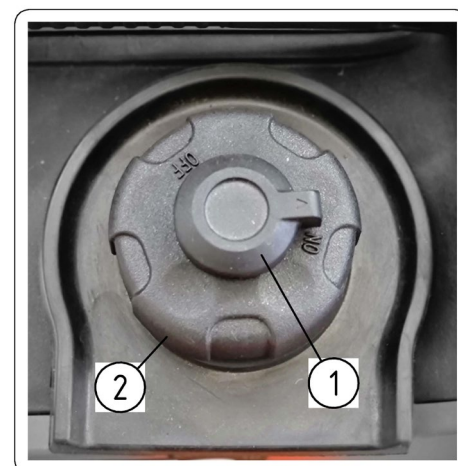

4.11 Terminal de aterramento

Terminal de aterramento ①



ATENÇÃO!
Ligar exclusivamente caso seja utilizado o Gerador ligado à rede em corrente alternada a 220 V.



5 PREPARAÇÃO

5.1 Combustível



ATENÇÃO!

O combustível é altamente inflamável e venenoso. Ler com atenção as "INFORMAÇÕES DE SEGURANÇA" com atenção antes do abastecimento.

- Não abastecer excessivamente o tanque de combustível, caso contrário poderá vazar quando o combustível se aquece e expande.
- Após abastecer o tanque de combustível, certificar-se de que a tampa do tanque de combustível esteja bem fechada.



AVISO!

- Limpar imediatamente o combustível que vazar com um pano macio, limpo e seco, pois o combustível pode deteriorar as superfícies pintadas ou as partes em plástico.
- Utilizar somente gasolina sem chumbo. O uso de gasolina com chumbo provoca graves danos às partes internas do motor.

5.2 Abastecimento Combustível



ATENÇÃO!

O combustível é altamente inflamável e venenoso. Ler com atenção as "INFORMAÇÕES DE SEGURANÇA" antes do abastecimento.

- Não abastecer excessivamente o tanque de combustível, caso contrário poderá vazar quando o combustível se aquece e expande.
- Após abastecer o tanque de combustível, certificar-se de que a tampa do tanque de combustível esteja bem fechada



ATENÇÃO!

- Limpar imediatamente o combustível que vazar com um pano macio, limpo e seco, pois o combustível pode deteriorar as superfícies pintadas ou as partes em plástico.
- Utilizar somente gasolina sem chumbo. O uso de gasolina com chumbo provoca graves danos às partes internas do motor.



AVISO!

Para efetuar o abastecimento, remover a tampa do tanque de combustível e encher o tanque até o nível vermelho ①.

Combustível recomendado:

Gasolina sem chumbo

Capacidade do tanque de combustível:

Total: 2.5L



5.3 Óleo motor



ATENÇÃO!

O Gerador é enviado sem óleo motor. Não efetuar o arranque do motor até quando não estiver abastecido com uma quantidade suficiente de óleo motor.



- Posicionar o Gerador

em uma superfície plana.

- Remover os parafusos ① e, então, remover a tampa ②.
- Remover a tampa de abastecimento de óleo ③.
- Abastecer a quantidade especificada do óleo motor recomendado, montar novamente a tampa do óleo ③.
- Montar novamente a tampa ②, apertar o parafuso ①.

Óleo motor recomendado:	SAE SJ 15W-40
Grau do óleo motor recomendado:	Tipo API Service SE ou superior
Quantidade de óleo motor:	0.31 L

5.4 VERIFICAR ANTES DO USO



AVISO!

- Antes de ligar o Gerador, verificar se está completamente inteiro, caso esteja danificado, é necessário repará-lo antes de colocá-lo para funcionar, os componentes vitais podem começar a se deteriorar rápida e inesperadamente, até mesmo quando o Gerador não é utilizado.
- A verificação da condição de um Gerador é de responsabilidade do proprietário.
- Os controlos antes da utilização devem ser efetuados sempre que o Gerador é utilizado.
- Antes da utilização, verificar o nível do **Combustível** (ver o par. 5.2), se necessário, abastecer.
- Antes da utilização, verificar o nível do **Óleo motor** (ver o par. 5.3), se necessário, abastecer.
- Antes do uso, verificar se o Gerador não apresenta vazamentos de óleo.

Em caso de anomalias não descritas no seguinte manual, contatar uma oficina autorizada.

6 FUNCIONAMENTO



ATENÇÃO!

Nunca acionar o motor num local fechado, pois as emissões dos gases de escape podem provocar a perda de consciência e até mesmo a morte em breve tempo. Fazer o motor funcionar em uma área bem ventilada.

- Antes que o Gerador seja ligado, não ligar nenhum dispositivo elétrico.
- O Gerador é enviado sem óleo motor, não ligar o motor até quando não estiver abastecido com a quantidade indicada (ver o par. 5.3).
- Não inclinar o Gerador quando abastecer o motor com óleo, pois pode provocar um abastecimento excessivo e danificar o motor.
- O Gerador pode ser utilizado com a carga nominal em saída em condições atmosféricas padrão:
 - Temperatura ambiente: 25°C
 - Pressão barométrica: 100kPa
 - Humidade relativa: 30%.
- A potência do Gerador varia de acordo com a mudança de temperatura, da altitude (pressão do ar mais baixa em alta altitude) e da humidade.
- A potência do gerador reduz-se quando a temperatura, a humidade e a altitude são superiores às condições atmosféricas standard.
- A carga deve ser reduzida quando é utilizado em espaços restritos, pois o arrefecimento do Gerador poderá ser afetado.

6.1 Arranque do motor

- 1- Posicionar o manípulo de escape em “On” ①

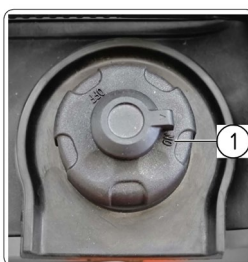

- 2- Girar a torneira do combustível ② até a posição **A**;
- 3- Deslocar a alavanca do Starter ③ até a posição **B**;

O Gerador está pronto para ser ligado.



AVISO!

Antes de ligar o Gerador com o motor quente, a alavanca do starter deve permanecer na posição “OPEN” (ABERTO).

- 4- Puxar lentamente a pega ② de arranque por enrolamento até que esteja engatada, depois puxá-la rapidamente para ligar o motor.



ATENÇÃO!

Segurar bem firme a pega de transporte ① para evitar que o Gerador caia caso seja puxado o arranque por enrolamento.

- 5- Após alguns minutos de funcionamento do motor, recolocar a alavanca do starter na posição **ABERTO**.

6.2 Arranque do motor

AVISO!

- Antes de ligar o motor do Gerador, desligar todos os dispositivos elétricos conectados.
- Deixar o interruptor do Gerador na posição “OFF” (ver o par. 4.7).
- Girar a torneira do combustível até a posição “0” FECHADO.

O circuito de acendimento está desligado, o combustível está



fechado.

- Depois que o motor estiver completamente arrefecido, girar o manípulo de escape do ar até “OFF” - 1.

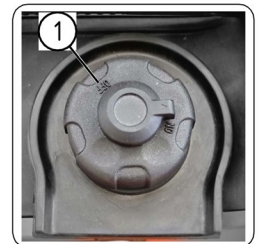

6.3 Ligação em corrente alternada (AC)

ATENÇÃO!

- Certificar-se de que todos os dispositivos elétricos estejam desligados antes de conectá-los ao Gerador.
- Certificar-se de que todos os dispositivos elétricos, incluindo os cabos e os conectores tipo ficha, estejam em boas condições antes de ligá-los ao Gerador.
- Certificar-se de que a carga total esta incluída na potência nominal do Gerador.
- Certificar-se de que a corrente de carga da tomada esteja incluída na corrente nominal da tomada.

NOTA: caso o Gerador esteja ligado à rede em corrente alternada a 220 V, até o Gerador deve ser aterrado através do terminal de Aterramento (ver o par. 4.11).

⚠️ ATENÇÃO!

Quando são utilizadas as ferramentas a 12 V, o interruptor inteligente “ESC” (ver o par. 4.8) deve estar taxativamente na posição 1 “ON”).

6.4 Campo de aplicação

⚠️ ATENÇÃO!

Quando é utilizado o Gerador, certificar-se de que a carga total esta incluída na potência nominal do Gerador. Caso contrário, podem ocorrer danos ao Gerador.

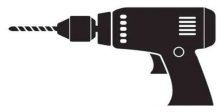
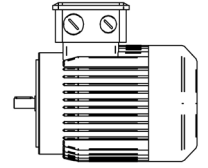
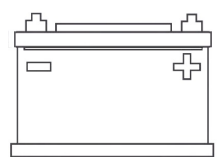
				
AC				DC
Fator de potência	1	0.8- 0.95	0.4-0.75 (Eficiência 0,85)	
lkW	<=1 000W	<=800W	<=400W	Tensão nominal 12V

⚠️ ATENÇÃO!

- A potência de aplicação indica quando cada dispositivo é usado sozinho.

EXEMPLO:

Potência nominal em saída do Gerador		1.000 w
Frequência	Fator de potência	
AC	1,0	<= 1.000W
	0,8	<= 800W
DC	---	700W(12Vx58.3A)

⚠️ ATENÇÃO!

O indicador de sobrecarga ② acende quando a potência total supera os dados de placa (ver o cap. 10).



⚠️ ATENÇÃO!

- Não sobrecarregar, a carga total de todos os equipamentos elétricos ligados não deve superar os dados de placa do Gerador. Uma sobrecarga danifica o Gerador.
- Quando são alimentados equipamentos de precisão, controladores eletrônicos, PC, computadores eletrônicos, equipamentos baseados em microcomputadores ou carregadores de bateria, manter o Gerador a uma distância suficiente para evitar interferências elétricas. Certificar-se também de que as frequências emitidas pelo Gerador não interfiram com outros dispositivos elétricos e eletrônicos situados nas proximidades do mesmo.
- Se o Gerador deve alimentar equipamentos médicos, é necessário consultar primeiro o fabricante ou um profissional do sector médico.
- Alguns equipamentos elétricos ou motores elétricos genéricos possuem correntes de arranque elevadas e, então, não podem ser utilizados, até mesmo caso estejam incluídos nos intervalos de alimentação indicados na tabela anterior. Consultar a fabricante do equipamento para maiores recomendações.

7 MANUTENÇÃO

ATENÇÃO!

- Antes de realizar qualquer operação de manutenção ordinária, desligar o Gerador.
- Todas as operações de manutenção não contempladas neste manual de uso e manutenção devem ser realizadas nos centros de assistência autorizados.



As operações de manutenção ordinária podem ser realizadas pelos operadores.

ATENÇÃO!

- O motor deve ser submetido a uma manutenção adequada para garantir um funcionamento seguro, económico e sem problemas, e também ecológico.
Para manter o motor a gasolina em boas condições de funcionamento, deve ser submetido a uma manutenção periódica. É necessário seguir atentamente o seguinte programa de manutenção e os procedimentos de inspeção de rotina:

Componente	Frequência	Sempre			
		Primeiro mês ou primeiras 20 horas de funcionamento	Sucessivamente, a cada 3 meses ou a cada 50 horas de funcionamento	A cada ano ou a cada 100 horas de funcionamento	
Óleo do motor	Controlo - Recarga	✓			
	Substituição		✓	✓	
Filtro de ar	Controlo	✓			
	Limpeza		✓		
	Substituição			✓	
Vela de ignição	Controlo-regulação				✓
	Substituição	A cada ano ou a cada 250 horas de funcionamento			
Protetor de faíscas	Limpeza				
Funcionamento ao mínimo (se fornecido) *	Controlo-regulação				✓
Tampa e filtro de combustível *	Limpeza				✓
Tubo do combustível	Controlo	A cada 2 anos (trocar, se necessário)			

* Estes componentes devem ser mantidos e consertados pelo nosso revendedor autorizado.

ATENÇÃO!

Parar o motor antes de proceder com a manutenção. Colocar o motor sobre uma superfície plana e remover a tampa da vela para impedir o arranque do motor.
Não acionar o motor num ambiente pouco ventilado ou num outro local fechado. Certificar-se de que seja mantida uma boa ventilação na área de trabalho. O escape do motor pode conter CO venenoso, a inalação pode provocar choque, perda de consciência e até mesmo a morte

ATENÇÃO!

- Caso o motor a gasolina funcione geralmente a temperaturas elevadas ou com cargas pesadas, trocar o óleo a cada 25 horas.
- Caso o motor funcione frequentemente em condições nas quais há muita poeira ou em outras circunstâncias graves, limpar o elemento filtrante do ar a cada 10 horas. Se necessário, substituir o elemento filtrante do ar a cada 25 horas.
- Respeitar os períodos de manutenção indicados.
- Caso o prazo previsto para a manutenção do motor não seja observado, providenciar o quanto antes.



OFICINA AUTORIZADA

É a oficina indicada pelos nossos revendedores, autorizada a realizar operações de reparação dos produtos.

7.1 Inspeção da vela



ATENÇÃO!

A vela é um componente importante do motor e deve ser controlada periodicamente.

1. Remover a cobertura ①, remover a tampa da vela ②; utilizando a chave fornecida com o Gerador, desaparafusar a vela girando em sentido anti-horário.
2. Verificar se não há resíduos de carbono e, eventualmente, removê-los com o auxílio de uma escova de aço.
3. Verificar se a candela corresponde com o modelo indicado: vela standard **A5RTC**

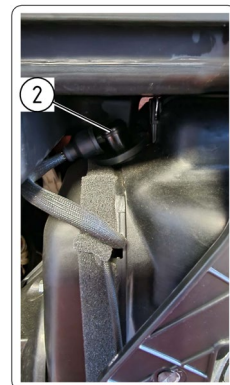

4. Com o auxílio de um calibrador, verificar a distância entre os elétrodos: 0,6-0,8 mm.
5. Remontar a vela com um binário de 12,5 Nm
6. Remontar a tampa da vela ② e a cobertura ①.

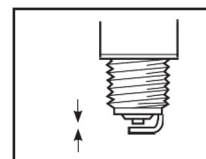

7.2 Regulação carburador



ATENÇÃO!

O carburador é um componente importante do motor, a sua manutenção e regulação deve ser efetuada por um centro de assistência autorizado.

7.3 Substituição do óleo do motor



ATENÇÃO!

- Evitar descarregar o óleo do motor após a paragem do motor. O óleo estará quente e deverá ser manuseado com cuidado para evitar queimaduras.
- Para a substituição do óleo, consultar o Parágrafo 5.3.



ATENÇÃO!

Não inclinar o gerador quando efetuar o abastecimento com óleo do motor. Isso poderá provocar um abastecimento excessivo e danos ao motor.

7.4 Filtro de ar

- Posicionar o Gerador em uma superfície plana.
- Remover os parafusos ① e, então, remover a tampa ②.
- Remover a tampa do filtro ③.
- Remover o filtro ③.
- Lavar o elemento em esponja utilizando sabão neutro e secá-lo.
- Lubrificar o elemento em esponja e eliminar o óleo em excesso. O elemento em esponja deve ser humedecido, mas não deverá gotejar.

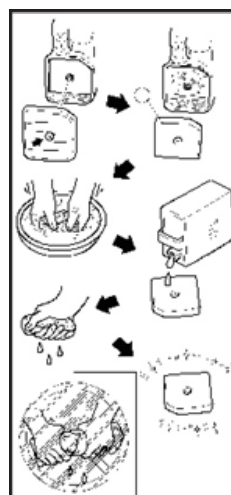

Poderá rasgar.



ATENÇÃO!

Não torcer o elemento em esponja durante esta operação.

- Inserir o elemento em esponja no corpo do filtro de ar, certificando-se de que a superfície de retenção do elemento em esponja faça aderir o filtro do ar, para que não ocorra vazamento de ar.



ATENÇÃO!

O motor nunca deverá funcionar sem o elemento em esponja; poderá provocar um desgaste excessivo do pistão e do cilindro.

- Remontar a tampa do corpo do filtro ③ do ar na sua posição original.

- Remontar a tampa ② e apertar o parafuso ①.

7.5 Blindagem do silenciador e do protetor de faíscas



ATENÇÃO!

O motor e o silenciador estarão muito quentes após o funcionamento do motor. Evitar tocar o motor e o silenciador, quando ainda estiverem quentes, com qualquer parte do corpo ou com a roupa durante a inspeção ou a reparação.

- Remover os parafusos ① e, então, remover a tampa ②.
- Soltar o parafusos ③, remover a faixa metálica do silenciador ④.
- Remover a tampa do silenciador ⑤.
- Limpar eventuais depósitos de carbono presentes no silenciador com uma escova metálica.

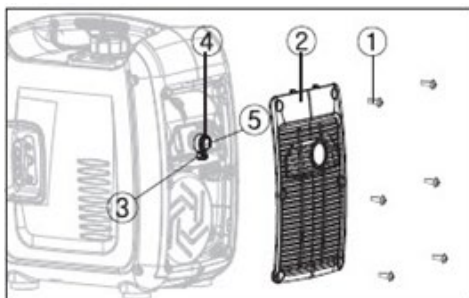

ATENÇÃO!

Durante a limpeza, utilizar delicadamente a escova metálica para evitar danificar o silenciador.

- Caso o silenciador esteja danificado, substituí-lo.
- Remontar o silenciador ⑤, a faixa metálica ④, a tampa ② e os parafusos ①.

7.6 Filtro do tanque de combustível



ATENÇÃO!

Nunca utilizar gasolina quando fumar ou nas proximidades de uma chama livre.

- Remover a tampa do tanque de combustível e o filtro.
- Limpar o filtro com gasolina e remontá-lo.
- Fechar novamente a tampa do tanque de combustível.



ATENÇÃO!

Certificar-se de que a tampa do tanque de combustível esteja bem fechado.

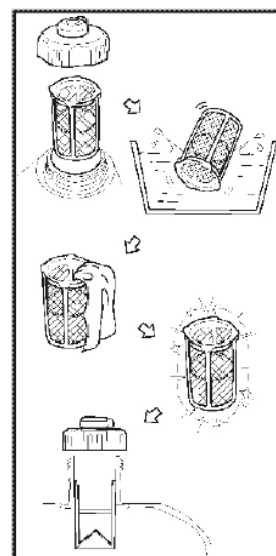

8 CONSERVAÇÃO



AVISO!

Caso a máquina não seja utilizada por um longo período, serão necessários alguns procedimentos para protegê-la contra a deterioração.

8.1 Descarga do combustível

- Girar a torneira do combustível até a posição "0" FECHADA.
- Remover a tampa do tanque de combustível e o filtro. Extrair o combustível do reservatório, colocando-o num recipiente de gasolina homologado. Então, remontar a tampa do tanque de combustível.



ATENÇÃO!

O combustível é altamente inflamável e venenoso, limpar imediatamente o combustível que vazar com um pano macio, limpo e seco, pois o combustível pode deteriorar as superfícies pintadas ou as partes em plástico.



AVISO!

Ligar o motor e deixá-lo funcionar até quando acabar o combustível residual, não ligar dispositivos elétricos, a operação deverá ser efetuada sem qualquer equipamento ligado à máquina. A duração do funcionamento da máquina sem qualquer equipamento ligado depende do combustível residual no reservatório.



AVISO!

Limpar o lado externo do Gerador, conservar em um local seco, bem ventilado e protegido.

9 RESOLUÇÃO DOS PROBLEMAS



ATENÇÃO!

Todas as intervenções de manutenção extraordinária têm de ser executadas por um técnico de manutenção mecânica experiente.

PROBLEMA	CAUSA	SOLUÇÃO
O motor não arranca.	- Combustível ausente no tanque. - Combustível presente no tanque.	- Abastecer o tanque de combustível. - Verificar a posição da válvula de ventilação na tampa do tanque (ver par. 4.9) Verificar a posição da torneira de combustível (ver par. 4.1).
	Carburador obstruído.	Levar o Gerador para um Centro de Assistência Autorizado da Fabricante.
Nível do óleo motor baixo (acende o indicador)	Falta óleo.	Abastecer o motor com óleo (ver par. 5.2).
Mau funcionamento elétrico/mecânico.	- Vela suja ou molhada. - Sistema de ligação defeituoso.	- Limpar e secar a vela (ver par. 7.1). - Levar o Gerador para um Centro de Assistência Autorizado da Fabricante.
O Gerador não produz energia.	- Dispositivo de segurança (proteção DC) em "OFF". - O indicador piloto AC (verde) desliga-se.	- Colocar a proteção DC em "ON". - Desligar o motor e ligá-lo novamente.

10 ESPECIFICAÇÕES TÉCNICAS

Modelo		1kW
Gerador	Tipo	Inversor silenciado
	Frequência nominal (Hz)	50/60
	Tensão nominal (V)	110/120/220/230/240
	Potência de saída nominal (kW)	1,0
	Fator de potência	1
	Capacidade do tanque de combustível (L)	2,5
	Qualidade da saída CA	ISO8528 G2
	Tensão de carga (DC) (V)	12
	Corrente de carga (DC) (A)	58.3
	Potência (DC) (W)	700
	Proteção de sobrecarga (DC)	Proteção sem fusíveis
Motor	Motor	R60-i
	Tipo de motor	Monocilíndrico, 4 tempos, arrefecimento a ar forçado, OHV
	Cilindrada (cc)	60
	Tipo de combustível	Gasolina sem chumbo
	Tempo de funcionamento contínuo (à potência nominal) (h)	4
	Capacidade de óleo (L)	0,31
	N. modelo vela	ASRTC
	Modalidade de arranque	Arranque por enrolamento
Gerador	Comprimento x largura x altura (mm)	380×240×420
	Peso líquido (kg)	13

11 DESMANTELAMENTO E ELIMINAÇÃO DOS COMPONENTES

11.1 Eliminação dos materiais gastos

A máquina, após a instalação e em seu funcionamento normal, não envolve riscos de contaminação ambiental, mas durante todo o período de uso são produzidos alguns tipos de resíduos ou materiais exaustos em condições particulares (por exemplo, a graxa de lubrificação das partes mecânicas).

Para a eliminação destes materiais existem, em cada país, normas específicas para a salvaguarda do meio ambiente. O cliente deve ter conhecimento das leis em matéria de resíduos poluentes vigentes no próprio país e operar de modo a cumprir as exigências legais; devem ser, ademais, respeitadas as indicações referidas nas fichas técnicas e de segurança dos produtos utilizados, que podem ser solicitadas junto aos respetivos fabricantes.



ATENÇÃO!

Respeitar a legislação em vigor sobre a eliminação de óleos minerais ou graxas usadas para lubrificação/manutenção.



ATENÇÃO!

Mais informações sobre os modos de eliminação de óleos e outras substâncias podem ser encontradas nas respetivas fichas técnicas e de segurança.

A eliminação dos resíduos tóxicos durante as fases de recolha, transporte, tratamento (operações de transformação necessárias para a recuperação), assim como o armazenamento e a descarga à terra são atividades de interesse público sujeitas à observância dos seguintes princípios gerais:

- a) Deve-se evitar qualquer dano ou perigo para a saúde, ou seja, devem ser garantidas a integridade e segurança, individual e coletivamente.
- b) Devem ser observados os preceitos higiénicos e sanitários, e evitados quaisquer riscos de poluição do ar, água, solo e sub-solo.

Deve ser promovido o respeito de critérios e métodos económicos e eficientes, a implantação de sistemas de recuperação e reciclagem de materiais e energia.

11.2 Indicações relativas aos resíduos especiais

Por resíduos especiais entendem-se os detritos gerados por processos industriais e os materiais provenientes da demolição de equipamentos e maquinarias deteriorados e obsoletos.

Os produtores de resíduos especiais, e também tóxicos e nocivos, são inteiramente responsáveis pela sua eliminação, direta ou através de órgãos autorizados; os resíduos podem também ser entregues a sujeitos autorizados que administram o serviço público, prévia celebração de um acordo específico.

Cada País/Município é obrigado a fornecer à sua Região todas as informações disponíveis sobre a eliminação de resíduos no seu território.



ATENÇÃO!

A eliminação abusiva de resíduos pode implicar a aplicação das sanções administrativas previstas pela normativa vigente.



ATENÇÃO!

De acordo com a Diretiva “REEE” 2012/19/UE, se o componente/produto adquirido estiver marcado com o seguinte símbolo do caixote de lixo barrado, significa que o produto no fim da sua vida útil deve ser recolhido separadamente dos outros resíduos.

A recolha diferenciada do presente componente/produto que alcançou o fim da sua vida útil é organizada e administrada pelo Fabricante. O utilizador que queira eliminar este equipamento deve, portanto, contactar o fabricante e seguir o sistema que ele adotou para permitir a recolha separada do equipamento que chegou ao fim da vida útil. Uma recolha diferenciada adequada e o sucessivo encaminhamento do equipamento desativado a processos de tratamento e eliminação ambientalmente compatíveis contribuem para evitar possíveis efeitos negativos sobre o meio ambiente e a saúde, para além de facilitar a reutilização e a reciclagem dos materiais que compõem o equipamento. A eliminação abusiva não em conforme com os requisitos especificados envolve a aplicação das sanções previstas pela normativa vigente localmente.



Σας ευχαριστούμε που επιλέξατε μια Γεννήτρια Campagna της RATO.

Αυτό το εγχειρίδιο περιέχει πληροφορίες σχετικά με τον τρόπο χρήσης του. Διαβάστε το προσεκτικά πριν από τη χρήση. Η ασφαλής και σωστή εργασία μπορεί να σας βοηθήσει να έχετε τα καλύτερα αποτελέσματα.

Όλες οι πληροφορίες που περιέχονται σε αυτή τη δημοσίευση βασίζονται στις πιο πρόσφατες πληροφορίες προϊόντος που ήταν διαθέσιμες τη στιγμή της εκτύπωσης. Τα περιεχόμενα αυτού του εγχειριδίου ενδέχεται να διαφέρουν από τα πραγματικά μέρη λόγω αναθεωρήσεων και άλλων αλλαγών.

Η εταιρεία μας διατηρεί το δικαίωμα να κάνει αλλαγές ανά πάσα στιγμή χωρίς προειδοποίηση και χωρίς καμία υποχρέωση. Κανένα μέρος αυτής της δημοσίευσης δεν μπορεί να αναπαραχθεί χωρίς τη γραπτή άδεια της εταιρείας μας.

Αυτό το εγχειρίδιο πρέπει να θεωρείται μόνιμο μέρος της Γεννήτριας και πρέπει να συνοδεύει τη Γεννήτρια σε περίπτωση μεταπώλησης.

ΠΡΟΕΙΔΟΠΟΙΗΣΕΙΣ ΑΣΦΑΛΕΙΑΣ



ΕΙΔΟΠΟΙΗΣΗ!

Η προσωπική σας ασφάλεια και η ασφάλεια της περιουσίας σας και των άλλων είναι πολύ σημαντική. Διαβάστε προσεκτικά τα μηνύματα που προηγούνται του συμβόλου.



ΚΙΝΔΥΝΟΣ!

Υπάρχει κίνδυνος ΘΑΝΑΤΟΥ ή σοβαρού ΤΡΑΥΜΑΤΙΣΜΟΥ εάν δεν ακολουθηθούν οι οδηγίες.



ΠΡΟΕΙΔΟΠΟΙΗΣΗ!

Υπάρχει κίνδυνος ΘΑΝΑΤΟΥ ή σοβαρού ΤΡΑΥΜΑΤΙΣΜΟΥ εάν δεν τηρηθούν οι οδηγίες.



ΠΡΟΣΟΧΗ!

Υπάρχει κίνδυνος ΤΡΑΥΜΑΤΙΣΜΟΥ εάν δεν τηρηθούν οι οδηγίες.

ΕΙΔΟΠΟΙΗΣΗ!

Η γεννήτρια ή άλλα προϊόντα μπορεί να καταστραφούν εάν δεν ακολουθηθούν οι οδηγίες.

ΠΡΟΕΙΔΟΠΟΙΗΣΕΙΣ ΑΣΦΑΛΕΙΑΣ	99
1 ΟΔΗΓΙΕΣ ΑΣΦΑΛΕΙΑΣ	101
2 ΘΕΣΗ ΤΩΝ ΣΗΜΑΝΤΙΚΩΝ ΕΤΙΚΕΤΩΝ	103
3 ΠΕΡΙΓΡΑΦΗ	104
3.1 Πίνακας Ελέγχου	104
4 ΕΛΕΓΧΟΣ ΤΩΝ ΛΕΙΤΟΥΡΓΙΩΝ	105
4.1 Βαλβίδα καυσίμου	105
4.2 Μοχλός εκκίνησης	105
4.3 Ενδεικτική λυχνία λαδιού (κόκκινη)	105
4.4 Ενδεικτική λυχνία υπερφόρτωσης (κόκκινη)	106
4.5 Πιλοτική λυχνία AC (πράσινη)	106
4.6 Προστατευτική διάταξη DC	106
4.7 Διακόπτης γεννήτριας	106
4.8 Έξυπνος διακόπτης (C)	107
4.9 Τάπα ρεζερβουάρ καυσίμου	107
4.10 Κουμπί εξαερισμού στην τάπα του ρεζερβουάρ καυσίμου	107
4.11 Ακροδέκτης γείωσης	107
5 ΠΡΟΕΤΟΙΜΑΣΙΑ	108
5.1 Καύσιμο	108
5.2 Ανεφοδιασμός καυσίμου	108
5.3 Λάδι μηχανής	108
5.4 ΕΛΕΓΞΤΕ ΠΡΙΝ ΤΗ ΧΡΗΣΗ	109
6 ΛΕΙΤΟΥΡΓΙΑ	109
6.1 Εκκίνηση του κινητήρα	109
6.2 Διακοπή λειτουργίας κινητήρα	110
6.3 Σύνδεση εναλλασσόμενου ρεύματος (AC)	110
6.4 Πεδίο εφαρμογής	111
7 ΣΥΝΤΗΡΗΣΗ	112
7.1 Επιθεώρηση μπουζί	113
7.2 Ρύθμιση καρμπυρατέρ	113
7.3 Αντικατάσταση λαδιού κινητήρα	113
7.4 Φίλτρο αέρα	113
7.5 Θώρακας του σιγαστήρα και προφυλακτήρας σπινθήρων	114
7.6 Φίλτρο ρεζερβουάρ καυσίμου	114
8 ΑΠΟΘΗΚΕΥΣΗ	115
8.1 Αποστράγγιση καυσίμου	115
9 ΑΝΤΙΜΕΤΩΠΙΣΗ ΠΡΟΒΛΗΜΑΤΩΝ	115
10 ΤΕΧΝΙΚΕΣ ΠΡΟΔΙΑΓΡΑΦΕΣ	116
11 ΔΙΑΛΥΣΗ ΚΑΙ ΔΙΑΘΕΣΗ ΕΞΑΡΤΗΜΑΤΩΝ ΩΣ ΑΠΟΒΛΗΤΑ	116
11.1 Απόρριψη των εξαντλημένων υλικών	116
11.2 Ενδείξεις για ειδικά απόβλητα	117

1 ΟΔΗΓΙΕΣ ΑΣΦΑΛΕΙΑΣ

Διαβάστε και κατανοήστε αυτό το εγχειρίδιο χρήστη πριν θέσετε σε λειτουργία τη Γεννήτρια. Η γνώση των διαδικασιών ασφαλούς λειτουργίας της Γεννήτριας θα σας βοηθήσει να αποφύγετε πιθανά ατυχήματα.



ΕΙΔΟΠΟΙΗΣΗ!

Σύνδεση σε οικιακή παροχή ρεύματος.

Εάν η Γεννήτρια πρόκειται να συνδεθεί σε οικιακή παροχή ρεύματος, η σύνδεση πρέπει να γίνει από επαγγελματία ηλεκτρολόγο ή άλλο άτομο με επαρκείς ηλεκτρολογικές δεξιότητες.

Όταν τα φορτία συνδέονται στη Γεννήτρια, ελέγξτε προσεκτικά εάν οι ηλεκτρικές συνδέσεις είναι ασφαλείς και αξιόπιστες. Η ακατάλληλη σύνδεση μπορεί να προκαλέσει ζημιά στη Γεννήτρια ή πυρκαγιά.

ΚΙΝΔΥΝΟΣ!

Η Γεννήτρια ΔΕΝ είναι φορτιστής μπαταριών και δεν μπορεί να χρησιμοποιηθεί ως φορτιστής καθώς δεν διαθέτει σύστημα ελέγχου και προστασίας για την χορηγούμενη τάση ρεύματος.

Η χρήση ως φορτιστή μπαταριών ΔΕΝ ΕΠΙΤΡΕΠΕΤΑΙ ΚΑΙ ΑΠΑΓΟΡΕΥΕΤΑΙ ΡΗΤΑ ΑΠΟ ΤΟΝ ΚΑΤΑΣΚΕΥΑΣΤΗ, καθώς υπάρχει εκτεταμένος κίνδυνος καταστροφής της μπαταρίας και της γεννήτριας. Σε περίπτωση πρόκλησης πυρκαγιάς εγκυμονεί σοβαρός κίνδυνος τραυματισμού.

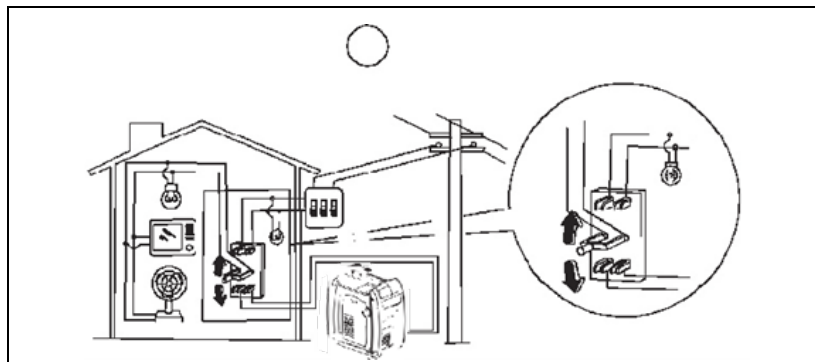
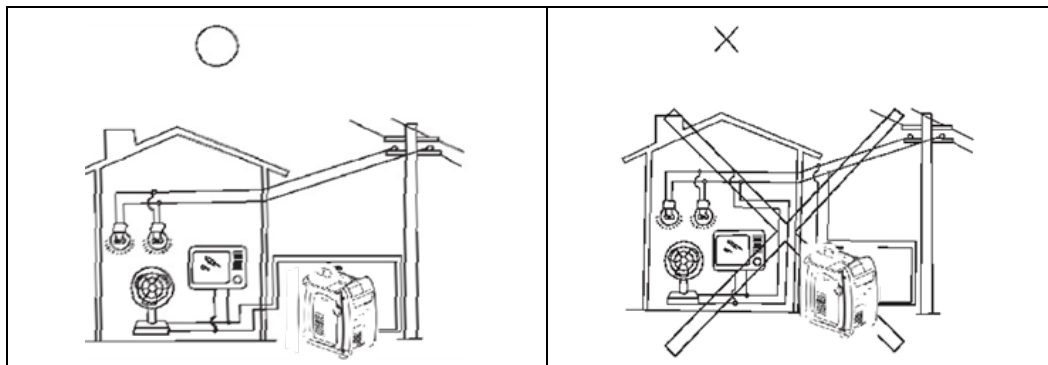

Κύκλωμα γείωσης της Γεννήτριας

Για την αποφυγή ηλεκτροπληξίας από κακές ηλεκτρικές συσκευές ή ακατάλληλη χρήση του ηλεκτρικού ρεύματος, η Γεννήτρια πρέπει να είναι γειωμένη με καλής ποιότητας μονωμένο αγωγό.

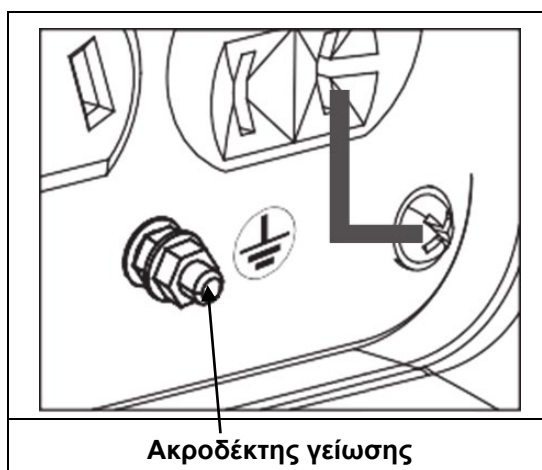

! ΕΙΔΟΠΟΙΗΣΗ!

Βεβαιωθείτε ότι ο πίνακας ελέγχου, η εισαγωγή αέρα και το κάτω μέρος του μετατροπέα έχουν κρυώσει καλά και ότι δεν υπάρχει βρωμιά, λάσπη και νερό. Το μπλοκάρισμα του αεραγωγού ψύξης μπορεί να προκαλέσει ζημιά στον κινητήρα, τον μετατροπέα ή τον εναλλάκτη.

Μην στοιβάζετε τη Γεννήτρια με άλλα αντικείμενα κατά τη μετακίνηση, την αποθήκευση ή τη λειτουργία της μονάδας. Αυτό μπορεί να προκαλέσει ζημιά στη Γεννήτρια ή να θέσει σε κίνδυνο την ασφάλεια των εγκαταστάσεων, αν η Γεννήτρια παρουσιάσει διαρροή.



2 ΘΕΣΗ ΤΩΝ ΣΗΜΑΝΤΙΚΩΝ ΕΤΙΚΕΤΩΝ

ΠΡΟΣΟΧΗ!

Πριν χρησιμοποιήσετε αυτό το μηχάνημα, διαβάστε προσεκτικά τους παρακάτω πίνακες.

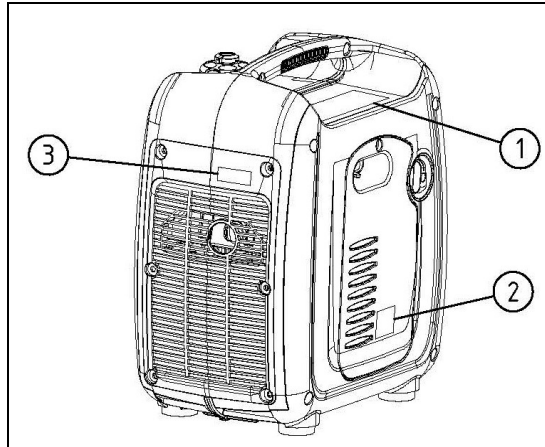
ΣΥΜΒΟΥΛΗ: Διατηρήστε ή αντικαταστήστε τις οδηγίες και τις ετικέτες ασφαλείας όπως απαιτείται.



 WARNING	
1	<ul style="list-style-type: none">● Read the owner's manual and all labels before operating.● Only operate in well-ventilated areas. Exhaust gas contains poisonous carbon monoxide.● Check for spilled fuel or fuel leaks.● Stop engine before refueling.● Do not operate near flammable materials.● Electrocutation can occur if generator is used in rain, snow, or near water. Keep this unit dry at all times.● Electrocutation or property damage can occur. Do not connect this generator to any building's electrical system unless an isolation switch has been installed by a licensed electrician. Refer to the owner's manual.● When operating the generator:<ul style="list-style-type: none">Never place a partition or other barrier around the generator.Do not cover the generator with a box.Do not place any objects on the generator.● Turn the fuel tank cap air vent knob to "OFF" after the engine has completely cooled down.
2	
3	

3 ΠΕΡΙΓΡΑΦΗ

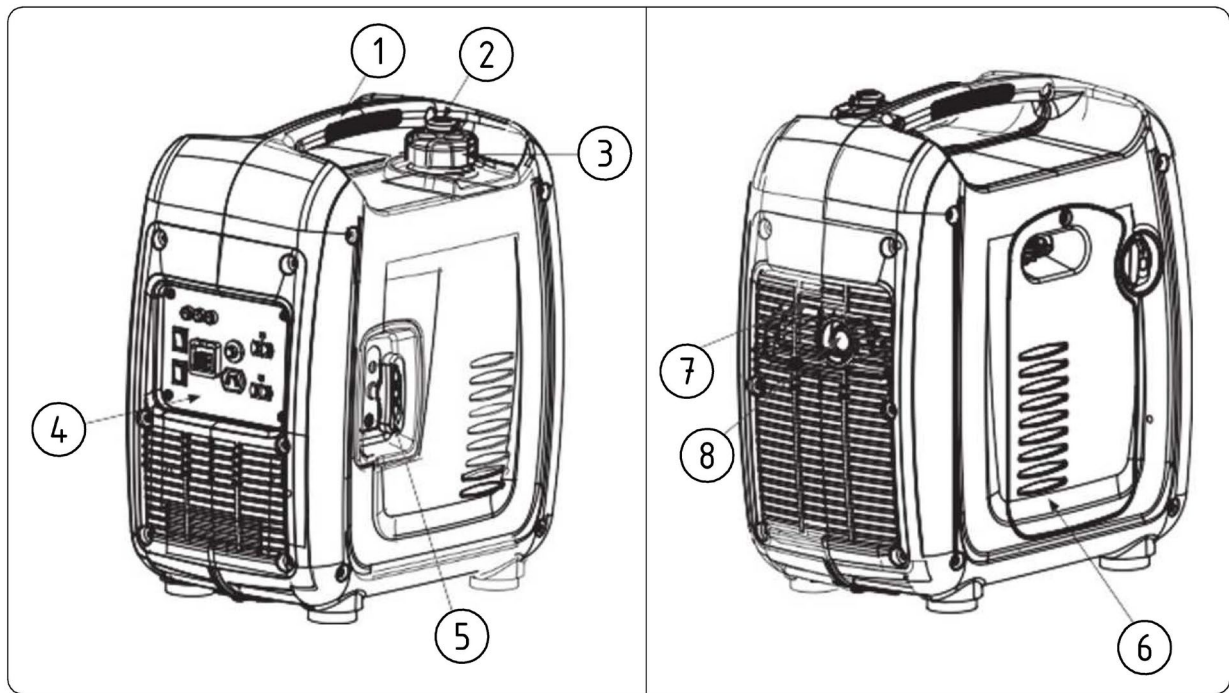

Θέση	Όνομασία
1	Λαβή μεταφοράς
2	Κουμπί εξαερισμού στην τάπα του ρεζερβουάρ καυσίμου
3	Τάπα ρεζερβουάρ καυσίμου
4	Πίνακας Ελέγχου
5	Σύστημα εκκίνησης με τράβηγμα
6	Τάπα πλήρωσης λαδιού
7	Αεραγωγός
8	Σιγαστήρας

3.1 Πίνακας Ελέγχου

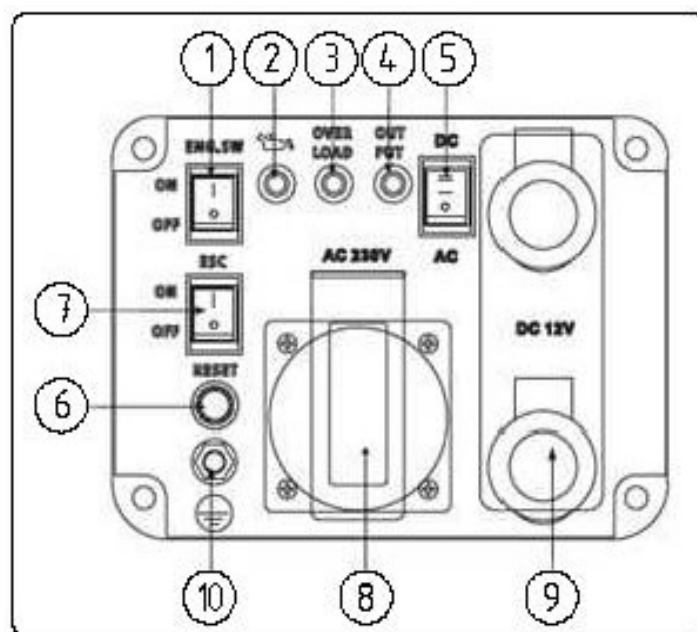

Θέση	Ονομασία
1	Διακόπτης
2	Γυαλί επιθεώρησης λαδιού
3	Ένδειξη υπερφόρτωσης
4	Πιλοτική λυχνία AC
5	Διακόπτης AC / DC (εναλλασσόμενο ρεύμα AC, DC συνεχές ρεύμα)
6	Επαναφορά AC
7	ESC (Έξυπνος έλεγχος κινητήρα)
8	Πρίζα AC
9	Συνδέσεις (+/-) DC
10	Ακροδέκτης γείωσης

4 ΕΛΕΓΧΟΣ ΤΩΝ ΛΕΙΤΟΥΡΓΙΩΝ

4.1 Βαλβίδα καυσίμου

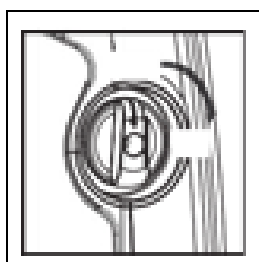

Η βαλβίδα καυσίμου ελέγχει τη ροή του καυσίμου από το ρεζερβουάρ στο καρμπυρατέρ. Φροντίστε να επαναφέρετε το μοχλό στο «OFF» αφού σταματήσετε τον κινητήρα.

4.2 Μοχλός εκκίνησης

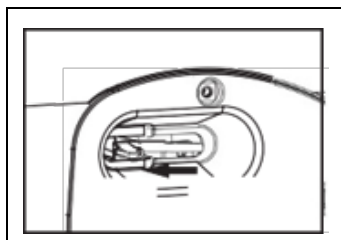

Ο μοχλός εκκίνησης χρησιμεύει για την παροχή ενός εμπλουτισμένου μείγματος καυσίμου, όταν είναι κρύος κατά την εκκίνηση. Αφού πάρει εμπρός ο κινητήρας, μετακινήστε αργά το μοχλό της μίζας στη θέση «OPEN».

ΣΥΜΒΟΥΛΗ: Το τσοκ δεν είναι απαραίτητο για την εκκίνηση ενός ζεστού κινητήρα.

4.3 Ενδεικτική λυχνία λαδιού (κόκκινη)



Όταν η στάθμη λαδιού πέσει κάτω από το ελάχιστο, ανάβει η ενδεικτική λυχνία ① και ο κινητήρας σταματά αυτόματα. Αν δεν αποκατασταθεί η στάθμη λαδιού, ο κινητήρας δεν επανεκκινείται.

ΣΥΜΒΟΥΛΗ: Εάν ο κινητήρας σταματήσει ή δεν ξεκινά, γυρίστε το διακόπτη του κινητήρα στο «ON» και τραβήξτε το σύστημα εκκίνησης με τράβηγμα. Εάν η ενδεικτική λυχνία λαδιού αναβοσβήνει για μερικά δευτερόλεπτα, σημαίνει ότι δεν υπάρχει επαρκές λάδι στον κινητήρα. Προσθέστε λάδι και επανεκκινήστε.

4.4 Ενδεικτική λυχνία υπερφόρτωσης (κόκκινη)

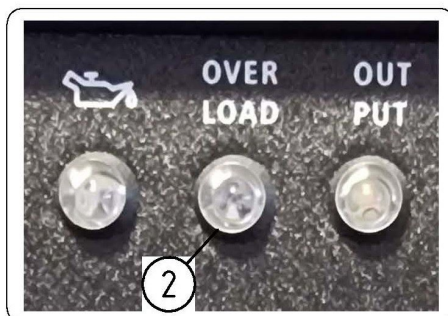

Η ενδεικτική λυχνία υπερφόρτωσης ② ανάβει όταν ανιχνευτεί υπερφόρτωση μιας συνδεδεμένης ηλεκτρικής συσκευής, η μονάδα ελέγχου μετατροπέα υπερθερμαίνεται ή η τάση εξόδου AC αυξάνεται. Στη συνέχεια, ενεργοποιείται η προστατευτική διάταξη AC, διακόπτοντας την παραγωγή ενέργειας για να προστατεύσει τη Γεννήτρια και τυχόν συνδεδεμένες ηλεκτρικές συσκευές. Η ενδεικτική λυχνία AC (πράσινη) σβήνει και η λυχνία υπερφόρτωσης (κόκκινη) παραμένει αναμμένη, αλλά ο κινητήρας δεν σταματά.

Όταν ανάψει η ενδεικτική λυχνία υπερφόρτωσης και σταματήσει η παραγωγή ηλεκτρικής ενέργειας, κάντε τα εξής:

1. Απενεργοποιήστε όλες τις συνδεδεμένες ηλεκτρικές συσκευές και σταματήστε τον κινητήρα.
2. Μειώστε τη συνολική ισχύ των συνδεδεμένων ηλεκτρικών συσκευών εντός του εύρους της ονομαστικής ισχύος.
3. Βεβαιωθείτε ότι δεν υπάρχουν εμπόδια στην είσοδο αέρα ψύξης και γύρω από τη μονάδα ελέγχου, εάν υπάρχουν εμπόδια, αφαιρέστε τα.
4. Μετά τον έλεγχο, επανεκκινήστε τον κινητήρα.

Συμβουλή: Η ενδεικτική λυχνία υπερφόρτωσης μπορεί να ανάψει για λίγα δευτερόλεπτα στην αρχή, όταν χρησιμοποιείτε ηλεκτρικές συσκευές που απαιτούν μεγάλο ρεύμα εκκίνησης, όπως ένας συμπιεστής ή μία υποβρύχια αντλία. Ωστόσο, δεν πρόκειται για δυσλειτουργία.

4.5 Πιλοτική λυχνία AC (πράσινη)



Η πιλοτική λυχνία AC ③ ανάβει όταν ο κινητήρας ξεκινά και παράγει ισχύ.

4.6 Προστατευτική διάταξη DC

4.7 Διακόπτης γεννήτριας

① - **On:** Εκκινήστε τη Γεννήτρια

② - **Off:** Στάση Γεννήτριας

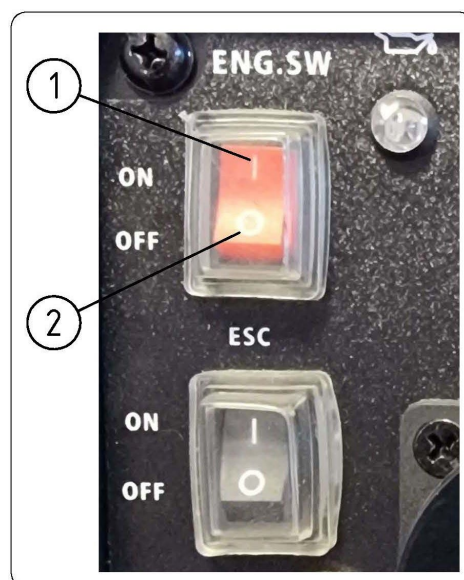

4.8 Έξυπνος διακόπτης (C)

Η έξυπνη λειτουργία, αν είναι ενεργοποιημένη (διακόπτης στο **1 «ON»**) επιτρέπει στον κινητήρα να λειτουργεί στο ρελαντί με μειωμένη κατανάλωση καυσίμου, σε συνθήκες απουσίας ή χαμηλού φορτίου. Καθώς αυξάνεται το φορτίο, αυξάνονται και οι στροφές του κινητήρα, για να παρέχουν περισσότερη ισχύ.

Με την έξυπνη λειτουργία απενεργοποιημένη (διακόπτης στο **0 «OFF»**), ο κινητήρας βρίσκεται πάντα στις μέγιστες στροφές για να παρέχει αμέσως τη μέγιστη ισχύ. Αυτή η λειτουργία είναι χρήσιμη όταν πρέπει να θέσετε σε λειτουργία ηλεκτρικά εργαλεία με υψηλή απορρόφηση κατά την εκκίνηση.

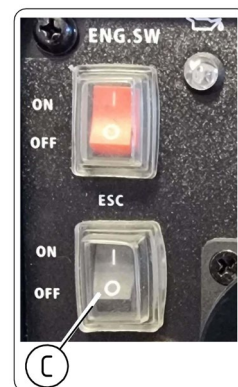

4.9 Τάπα ρεζερβουάρ καυσίμου

Αφαιρέστε την τάπα του ρεζερβουάρ καυσίμου περιστρέφοντάς την αριστερόστροφα.

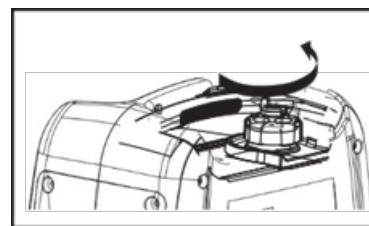

4.10 Κουμπί εξαερισμού στην τάπα του ρεζερβουάρ καυσίμου

Η τάπα του ρεζερβουάρ καυσίμου **2** διαθέτει πόμολο εξαερισμού για **1** σταματήσει τη ροή του καυσίμου.

Το κουμπί εξαερισμού πρέπει να είναι στη θέση **«ON»**. Αυτό θα επιτρέψει στο καύσιμο να ρέει στο καρμπυρατέρ και στον κινητήρα να λειτουργεί.

Όταν ο κινητήρας δεν χρησιμοποιείται, γυρίστε το κουμπί εξαερισμού στο **«OFF»** για να σταματήσει η ροή του καυσίμου.

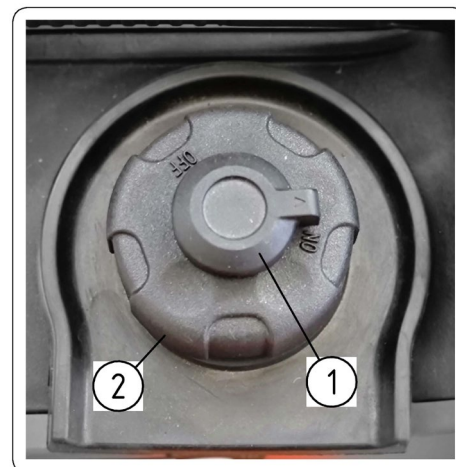

4.11 Ακροδέκτης γείωσης

Ακροδέκτης γείωσης **1**



ΠΡΟΣΟΧΗ!

Συνδέεται μόνο εάν χρησιμοποιείται η Γεννήτρια που είναι συνδεδεμένη στο δίκτυο AC 220 V.



5 ΠΡΟΕΤΟΙΜΑΣΙΑ

5.1 Καύσιμο



ΠΡΟΣΟΧΗ!

Το καύσιμο είναι πολύ εύφλεκτο και τοξικό. Διαβάστε προσεκτικά τις «ΠΛΗΡΟΦΟΡΙΕΣ ΑΣΦΑΛΕΙΑΣ» πριν γεμίσετε.

- Μην γεμίζετε υπερβολικά το ρεζερβουάρ καυσίμου, γιατί θα μπορούσε να υπερχειλίσει, επειδή το καύσιμο θερμαίνεται και διαστέλλεται.
- Αφού γεμίσετε το ρεζερβουάρ καυσίμου, βεβαιωθείτε ότι η τάπα του ρεζερβουάρ καυσίμου είναι σφιχτή.



ΕΙΔΟΠΟΙΗΣΗ!

- Σκουπίστε αμέσως το χυμένο καύσιμο με ένα μαλακό, καθαρό, στεγνό πανί, γιατί αλλιώς θα μπορούσε να αλλοιώσει τις βαμμένες επιφάνειες ή τα πλαστικά μέρη.
- Χρησιμοποιείτε μόνο αμόλυβδη βενζίνη. Η χρήση βενζίνης με μόλυβδο προκαλεί σοβαρές βλάβες στα εσωτερικά μέρη του κινητήρα.

5.2 Ανεφοδιασμός καυσίμου



ΠΡΟΣΟΧΗ!

Το καύσιμο είναι πολύ εύφλεκτο και τοξικό. Διαβάστε προσεκτικά τις «ΠΛΗΡΟΦΟΡΙΕΣ ΑΣΦΑΛΕΙΑΣ» πριν γεμίσετε.

- Μην γεμίζετε υπερβολικά το ρεζερβουάρ καυσίμου, γιατί μπορεί να υπερχειλίσει καθώς το καύσιμο θερμαίνεται και διαστέλλεται.
- Αφού γεμίσετε το ρεζερβουάρ καυσίμου, βεβαιωθείτε ότι η τάπα του ρεζερβουάρ καυσίμου είναι σφιχτή



ΠΡΟΣΟΧΗ!

- Σκουπίστε αμέσως το χυμένο καύσιμο με ένα μαλακό, καθαρό, στεγνό πανί, γιατί αλλιώς θα μπορούσε να αλλοιώσει τις βαμμένες επιφάνειες ή τα πλαστικά μέρη.
- Χρησιμοποιείτε μόνο αμόλυβδη βενζίνη. Η χρήση βενζίνης με μόλυβδο προκαλεί σοβαρές βλάβες στα εσωτερικά μέρη του κινητήρα.



ΠΡΟΕΙΔΟΠΟΙΗΣΗ!

Για ανεφοδιασμό καυσίμου, αφαιρέστε την τάπα του ρεζερβουάρ καυσίμου και γεμίστε το ρεζερβουάρ έως το κόκκινο επίπεδο ①.

Προτεινόμενο καύσιμο:

Αμόλυβδη βενζίνη

ΧΩΡΗΤΙΚΟΤΗΤΑ ΡΕΖΕΡΒΟΥΑΡ ΚΑΥΣΙΜΩΝ:

Σύνολο: 2,5 λίτρα

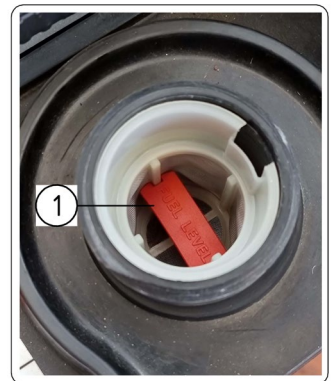

5.3 Λάδι μηχανής



ΠΡΟΣΟΧΗ!

Η γεννήτρια αποστέλλεται χωρίς λάδι στον κινητήρα. Μην εκκινήσετε τον κινητήρα μέχρι να γεμίσει με επαρκή ποσότητα λαδιού.



- Τοποθετήστε τη

γεννήτρια σε μια επίπεδη επιφάνεια.

- Αφαιρέστε τις βίδες ① . Στη συνέχεια, αφαιρέστε το κάλυμμα ② .
- Αφαιρέστε την τάπα πλήρωσης λαδιού ③ .
- Γεμίστε ξανά την καθορισμένη ποσότητα του συνιστώμενου λαδιού κινητήρα. Τοποθετήστε ξανά την τάπα λαδιού ③ .
- Τοποθετήστε ξανά το κάλυμμα ② και σφίξτε τη βίδα ① .

Συνιστώμενο λάδι κινητήρα:	SAE SJ 15W-40
Συνιστώμενη κατηγορία λαδιού κινητήρα:	API υπηρεσίας τύπου SE ή νεότερο
Ποσότητα λαδιού κινητήρα:	0,31 λίτρα

5.4 ΕΛΕΓΞΤΕ ΠΡΙΝ ΤΗ ΧΡΗΣΗ

ΕΙΔΟΠΟΙΗΣΗ!

- Πριν θέσετε σε λειτουργία τη Γεννήτρια, βεβαιωθείτε ότι είναι όλα της τα μέρη είναι ακέραια. Αν έχει υποστεί ζημιά, επισκευάστε την πριν τη θέσετε σε λειτουργία. Τα βασικά εξαρτήματα μπορεί να αρχίσουν να φθείρονται γρήγορα και απροσδόκητα, ακόμα κι αν η Γεννήτρια δεν χρησιμοποιείται.
- Ο έλεγχος της κατάστασης μιας Γεννήτριας είναι ευθύνη του ιδιοκτήτη.
- Πρέπει να γίνονται έλεγχοι πριν από τη χρήση κάθε φορά που χρησιμοποιείται η Γεννήτρια.
- Πριν από τη χρήση, ελέγξτε το επίπεδο του **Καυσίμου** (βλ. παρ. 5.2). Συμπληρώστε, αν χρειάζεται.
- Πριν από τη χρήση, ελέγξτε το επίπεδο του **Λαδιού κινητήρα** (βλ. παρ. 5.3). Συμπληρώστε, αν χρειάζεται.
- Πριν από τη χρήση, βεβαιωθείτε ότι η γεννήτρια δεν έχει διαρροές λαδιού.

Σε περίπτωση ανωμαλιών που δεν περιγράφονται σε αυτό το εγχειρίδιο, επικοινωνήστε με ένα εξουσιοδοτημένο συνεργείο.

6 ΛΕΙΤΟΥΡΓΙΑ

ΠΡΟΣΟΧΗ!

Ποτέ μην λειτουργείτε τον κινητήρα σε κλειστό χώρο, επειδή οι εκπομπές καυσαερίων θα μπορούσαν να προκαλέσουν απώλεια των αισθήσεων και ακόμη και θάνατο σε σύντομο χρονικό διάστημα. Λειτουργήστε τον κινητήρα σε καλά αεριζόμενο χώρο.

- Προτού τεθεί σε λειτουργία η Γεννήτρια, μην συνδέετε καμία ηλεκτρική συσκευή.
- Η γεννήτρια αποστέλλεται χωρίς λάδι στον κινητήρα, μην ξεκινήσετε τον κινητήρα μέχρι να γεμίσει με την αναγραφόμενη ποσότητα (βλ. παρ. 5.3).
- Μην γέρνετε τη Γεννήτρια όταν προσθέτετε λάδι στον κινητήρα, γιατί θα μπορούσε να προκαλέσει υπερπλήρωση και ζημιά στον κινητήρα.
- Η γεννήτρια μπορεί να χρησιμοποιηθεί με το ονομαστικό φορτίο εξόδου σε τυπικές ατμοσφαιρικές συνθήκες:
 - Θερμοκρασία χώρου: 25 °C
 - Βαρομετρική πίεση: 100 kPa
 - Σχετική υγρασία: 30%.
- Η ισχύς της Γεννήτριας ποικίλλει ανάλογα με την αλλαγή θερμοκρασίας, το υψόμετρο (χαμηλότερη πίεση αέρα σε μεγάλο υψόμετρο) και την υγρασία.
- Η ισχύς της γεννήτριας μειώνεται όταν η θερμοκρασία, η υγρασία και το υψόμετρο είναι πάνω από τις τυπικές ατμοσφαιρικές συνθήκες.
- Το φορτίο πρέπει να μειωθεί όταν χρησιμοποιείται σε περιορισμένους χώρους, επειδή επηρεάζεται η ψύξη της Γεννήτριας.

6.1 Εκκίνηση του κινητήρα

- 1- Τοποθετήστε το κουμπί εξαερισμού στο «ON» ①

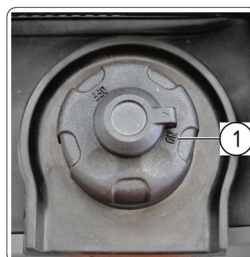

- 2- Γυρίστε τη στρόφιγγα καυσίμου ② στη θέση **A**.

- 3- Μετακινήστε το μοχλό του τσοκ ③ στη θέση **B**.

Η γεννήτρια είναι έτοιμη για εκκίνηση.



ΕΙΔΟΠΟΙΗΣΗ!

Για να εκκινήσετε τη Γεννήτρια με ζεστό κινητήρα, ο μοχλός του τσοκ πρέπει να παραμείνει στη θέση «**OPEN**».

- 4- Τραβήξτε αργά τη λαβή ② εκκίνησης, μέχρι να εμπλακεί, και, στη συνέχεια, τραβήξτε την γρήγορα για να εκκινήσετε τον κινητήρα.



ΠΡΟΣΟΧΗ!

Κρατήστε σταθερά τη λαβή μεταφοράς ① για να αποτρέψετε την πτώση της Γεννήτριας, όταν τραβάτε τον ιμάντα εκκίνησης.

- 5- Μετά από λίγα λεπτά λειτουργίας του κινητήρα, επαναφέρετε τον μοχλό του τσοκ στη θέση **OPEN**.

6.2 Διακοπή λειτουργίας κινητήρα

ΕΙΔΟΠΟΙΗΣΗ!

- Πριν σταματήσετε τον κινητήρα της Γεννήτριας, απενεργοποιήστε όλες τις συνδεδεμένες ηλεκτρικές συσκευές.
- Γυρίστε το διακόπτη της Γεννήτριας στη θέση «**OFF**» (βλ. παρ. 4.7).
- Γυρίστε τη στρόφιγγα καυσίμου στη θέση «**0**» **CLOSE**.

Το κύκλωμα ανάφλεξης είναι σβηστό και το καύσιμο είναι κλειστό.



- Αφού κρυώσει τελείως ο κινητήρας, γυρίστε το κουμπί εξαερισμού αέρα στο «**OFF**» - 1.

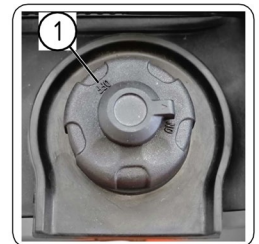

6.3 Σύνδεση εναλλασσόμενου ρεύματος (AC)

ΠΡΟΣΟΧΗ!

- Βεβαιωθείτε ότι όλες οι ηλεκτρικές συσκευές είναι απενεργοποιημένες πριν τις συνδέσετε στη Γεννήτρια.
- Βεβαιωθείτε ότι όλες οι ηλεκτρικές συσκευές, συμπεριλαμβανομένων των καλωδίων και των βυσμάτων σύνδεσης, είναι σε καλή κατάσταση πριν τις συνδέσετε στη Γεννήτρια.
- Βεβαιωθείτε ότι το συνολικό φορτίο είναι εντός της ονομαστικής ισχύος της Γεννήτριας.
- Βεβαιωθείτε ότι το ρεύμα φορτίου της πρίζας είναι εντός του ονομαστικού ρεύματος της πρίζας.

ΣΗΜΕΙΩΣΗ: Αν η Γεννήτρια είναι συνδεδεμένη στο δίκτυο AC 220 V, πρέπει επίσης να συνδεθεί στη γείωση μέσω του ακροδέκτη Γείωσης (βλ. παρ. 4.11).



! ΠΡΟΣΟΧΗ!

Όταν χρησιμοποιείτε εργαλεία για 12 V, ο έξυπνος διακόπτης «ESC» (βλ. παρ. 4.8) πρέπει οπωσδήποτε να βρίσκεται στη θέση 1 «ON»).

6.4 Πεδίο εφαρμογής

! ΠΡΟΣΟΧΗ!

Όταν χρησιμοποιείτε τη Γεννήτρια, βεβαιωθείτε ότι το συνολικό φορτίο είναι εντός της ονομαστικής ισχύος της Γεννήτριας. Διαφορετικά, μπορεί να προκληθεί ζημιά στη Γεννήτρια.

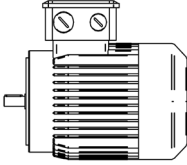
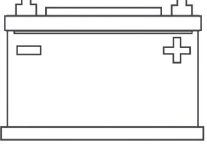
				
AC				DC
Συντελεστής ισχύος	1	0,8- 0,95	0,4-0,75 (Απόδοση 0,85)	
kW	$\leq 1000W$	$\leq 800W$	$\leq 400W$	Ονομαστική τάση 12V

! ΠΡΟΣΟΧΗ!

- Η ισχύς εφαρμογής υποδεικνύει πότε κάθε συσκευή χρησιμοποιείται μόνη της.

ΠΑΡΑΔΕΙΓΜΑ:

Ονομαστική ισχύς εξόδου της Γεννήτριας		1.000 w
Συχνότητα	Συντελεστής ισχύος	
AC	1,0	$\leq 1.000W$
	0,8	$\leq 800W$
DC	---	700W (12Vx58,3A)

! ΠΡΟΣΟΧΗ!

Η ένδειξη υπερφόρτωσης ② ανάβει όταν η συνολική ισχύς υπερβαίνει τα δεδομένα της πινακίδας (βλ. κεφ. 10).



! ΠΡΟΣΟΧΗ!

- Μην υπερφορτώνετε, το συνολικό φορτίο όλων των συνδεδεμένων ηλεκτρικών συσκευών δεν πρέπει να υπερβαίνει τα δεδομένα της πινακίδας της γεννήτριας. Η ενδεχόμενη υπερφόρτωση προκαλεί βλάβες στη Γεννήτρια.
- Κατά την τροφοδοσία εξοπλισμού ακριβείας, ηλεκτρονικών ελεγκτών, υπολογιστών, ηλεκτρονικών υπολογιστών, εξοπλισμού με μικροϋπολογιστή ή φορτιστών μπαταριών, κρατήστε τη Γεννήτρια αρκετά μακριά για να αποφύγετε ηλεκτρικές παρεμβολές. Βεβαιωθείτε επίσης ότι οι συχνότητες που εκπέμπονται από τη Γεννήτρια δεν προκαλούν παρεμβολές στις άλλες ηλεκτρικές και ηλεκτρονικές συσκευές που βρίσκονται κοντά της.
- Αν η Γεννήτρια πρόκειται να τροφοδοτήσει ιατρικό εξοπλισμό, πρέπει πρώτα να συμβουλευτείτε τον κατασκευαστή ή έναν επαγγελματία ιατρό.
- Ορισμένες ηλεκτρικές συσκευές ή ηλεκτρικοί κινητήρες γενικής χρήσης έχουν υψηλά ρεύματα εκκίνησης και επομένως δεν μπορούν να χρησιμοποιηθούν, ακόμα κι αν βρίσκονται εντός των ορίων τροφοδοσίας που αναφέρονται στον παραπάνω πίνακα. Συμβουλευτείτε τον κατασκευαστή του εξοπλισμού για περαιτέρω συμβουλές.

7 ΣΥΝΤΗΡΗΣΗ

ΠΡΟΣΟΧΗ!

- Πριν πραγματοποιήσετε οποιαδήποτε τακτική συντήρηση, σταματήστε τη Γεννήτρια.
- Όλες οι εργασίες συντήρησης που δεν εξετάζονται στο παρόν εγχειρίδιο πρέπει να εκτελούνται στα εξουσιοδοτημένα κέντρα τεχνικής υποστήριξης.



Οι εργασίες απλής συντήρησης θα πρέπει να εκτελούνται από τους χειριστές.

ΠΡΟΣΟΧΗ!

- Ο κινητήρας πρέπει να συντηρείται σωστά για να διασφαλίζεται η ασφαλής, οικονομική και απρόσκοπτη λειτουργία, καθώς και φιλική προς το περιβάλλον. Για να διατηρείται ο βενζινοκινητήρας σε καλή κατάσταση λειτουργίας, πρέπει να υποβάλλεται σε περιοδική συντήρηση. Το ακόλουθο πρόγραμμα συντήρησης και οι συνήθεις διαδικασίες επιθεώρησης πρέπει να τηρούνται προσεκτικά:

Εξάρτημα	Συχνότητα	Κάθε φορά	Πρώτος μήνας ή πρώτες 20 ώρες λειτουργίας	Στη συνέχεια, κάθε 3 μήνες ή κάθε 50 ώρες λειτουργίας	Κάθε έτος ή κάθε 100 ώρες λειτουργίας
Λάδι μηχανής	Έλεγχος - Συμπλήρωση	✓			
	Αντικατάσταση		✓	✓	
Φίλτρο αέρα	Έλεγχος	✓			
	Καθαρισμός		✓		
	Αντικατάσταση			✓	
Μπουζί	Έλεγχος-ρύθμιση				✓
	Αντικατάσταση	Κάθε χρόνο ή κάθε 250 ώρες λειτουργίας			
Προστατευτικό σπινθήρα	Καθαρισμός				
Λειτουργία ρελαντί (αν υπάρχει) *	Έλεγχος-ρύθμιση				✓
Ρεζερβουάρ καυσίμου και φίλτρο *	Καθαρισμός				✓
Σωλήνας καυσίμου	Έλεγχος	Κάθε 2 χρόνια (αλλάξτε, αν χρειάζεται)			

* Αυτά τα εξαρτήματα πρέπει να συντηρούνται και να επισκευάζονται από τον εξουσιοδοτημένο αντιπρόσωπό μας.

ΠΡΟΣΟΧΗ!

Σβήστε τον κινητήρα πριν από τη συντήρηση. Τοποθετήστε τον κινητήρα σε επίπεδη επιφάνεια και αφαιρέστε το καπάκι του μπουζί για να αποτρέψετε την εκκίνηση του κινητήρα.

Μην λειτουργείτε τον κινητήρα σε κακώς αεριζόμενο ή άλλο κλειστό χώρο. Φροντίστε να διατηρείτε καλό αερισμό στην περιοχή εργασίας. Τα καυσαέρια του κινητήρα μπορεί να περιέχουν δηλητηριώδες CO. Η εισπνοή μπορεί να προκαλέσει σοκ, απώλεια των αισθήσεων και ακόμα και θάνατο

ΠΡΟΣΟΧΗ!

- Αν ο βενζινοκινητήρας λειτουργεί συχνά σε υψηλές θερμοκρασίες ή υπό μεγάλα φορτία, αλλάζετε το λάδι κάθε 25 ώρες.
- Αν ο κινητήρας λειτουργεί συχνά σε συνθήκες σκόνης ή άλλες σοβαρές συνθήκες, καθαρίστε το στοιχείο φίλτρου αέρα κάθε 10 ώρες. Αν είναι απαραίτητο, αντικαταστήστε το στοιχείο φίλτρου αέρα κάθε 25 ώρες.
- Τηρείτε τις υποδεικνυόμενες περιόδους συντήρησης.
- Αν δεν έχει τηρηθεί η προθεσμία για τη συντήρηση του κινητήρα, λάβετε μέτρα το συντομότερο δυνατό.



ΕΞΟΥΣΙΟΔΟΤΗΜΕΝΟ ΣΥΝΕΡΓΕΙΟ

Είναι το συνεργείο που υποδεικνύεται από τους αντιπροσώπους μας, εξουσιοδοτημένο να πραγματοποιεί εργασίες επισκευής προϊόντων.

7.1 Επιθεώρηση μπουζί



ΠΡΟΣΟΧΗ!

Το μπουζί είναι ένα σημαντικό εξάρτημα του κινητήρα και πρέπει να είναι ελέγχεται περιοδικά.

1. Αφαιρέστε το καπάκι ①. Αφαιρέστε το καπάκι του μπουζί ②. Χρησιμοποιώντας το κλειδί που παρέχεται με τη Γεννήτρια, ξεβιδώστε το μπουζί γυρίζοντάς το αριστερόστροφα.
2. Βεβαιωθείτε ότι δεν υπάρχουν υπολείμματα καπνιάς. Αν χρειάζεται, αφαιρέστε τα με τη βοήθεια μιας χαλύβδινης βούρτσας.
3. Βεβαιωθείτε ότι το μπουζί ταιριάζει με το εμφανιζόμενο μοντέλο. Προβλεπόμενο μπουζί: **A5RTC**.

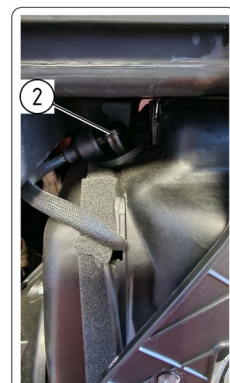

4. Χρησιμοποιώντας ένα παχύμετρο, ελέγξτε την απόσταση μεταξύ των ηλεκτροδίων: 0,6-0,8 mm.
5. Τοποθετήστε ξανά το μπουζί, με ροπή σύσφιξης 12,5 Nm.
6. Τοποθετήστε ξανά το καπάκι του μπουζί ② και το καπάκι ①.

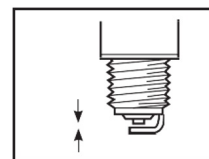

7.2 Ρύθμιση καρμπυρατέρ



ΠΡΟΣΟΧΗ!

Το καρμπυρατέρ είναι σημαντικό εξάρτημα του κινητήρα, η συντήρηση και η ρύθμισή του πρέπει να γίνονται από εξουσιοδοτημένο κέντρο σέρβις.

7.3 Αντικατάσταση λαδιού κινητήρα



ΠΡΟΣΟΧΗ!

- Αποφύγετε την αποστράγγιση του λαδιού κινητήρα αμέσως μετά το σβήσιμο του κινητήρα. Το λάδι είναι καυτό και πρέπει να το χειρίζεστε με προσοχή για την αποφυγή εγκαυμάτων.
- Για να αντικαταστήσετε το λάδι, ανατρέξτε στην παράγραφο 5.3.



ΠΡΟΣΟΧΗ!

Μην γέρνετε τη γεννήτρια όταν προσθέτετε λάδι στον κινητήρα. Αυτό θα μπορούσε να προκαλέσει υπερπλήρωση και ζημιά στον κινητήρα.

7.4 Φίλτρο αέρα

- Τοποθετήστε τη γεννήτρια σε μια επίπεδη επιφάνεια.
- Αφαιρέστε τη βίδα ①, στη συνέχεια αφαιρέστε το κάλυμμα ②.
- Αφαιρέστε το κάλυμμα του φίλτρου ③.
- Αφαιρέστε το φίλτρο ③.
- Πλύνετε το σφουγγαρωτό στοιχείο με ουδέτερο απορρυπαντικό και στεγνώστε το.
- Λαδώστε το σφουγγαρωτό στοιχείο και σκουπίστε το περίσσιο λάδι. Το σφουγγαρωτό στοιχείο πρέπει να υγραίνεται αλλά να μην στάζει.

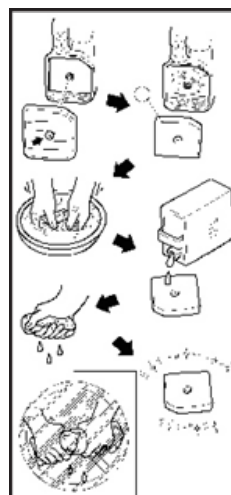

ΠΡΟΣΟΧΗ!

Μην στύβετε το σφουγγαρωτό στοιχείο κατά τη διάρκεια αυτής της λειτουργίας. Θα μπορούσε να σκιστεί.

- Εισαγάγετε το σφουγγαρωτό στοιχείο στο σώμα του φίλτρου αέρα. Βεβαιωθείτε ότι η επιφάνεια στεγανοποίησης του σφουγγαρωτού στοιχείου προσκολλάται στο φίλτρο αέρα, έτσι ώστε να μην υπάρχει διαρροή αέρα.



ΠΡΟΣΟΧΗ!

Ο κινητήρας δεν πρέπει ποτέ να λειτουργεί χωρίς το σφουγγαρωτό στοιχείο. Αυτό μπορεί να οδηγήσει σε υπερβολική φθορά του εμβόλου και του κυλίνδρου.

- Τοποθετήστε ξανά το κάλυμμα του σώματος του φίλτρου ③ του αέρα στην αρχική του θέση.



- Τοποθετήστε ξανά το καπάκι ② και σφίξτε τη βίδα ①.

7.5 Θώρακας του σιγαστήρα και προφυλακτήρας σπινθήρων



ΠΡΟΣΟΧΗ!

Ο κινητήρας και ο σιγαστήρας θα είναι πολύ ζεστοί μετά τη λειτουργία του κινητήρα. Αποφύγετε να αγγίζετε τον κινητήρα και τον σιγαστήρα, όσο είναι ακόμα ζεστοί, με οποιοδήποτε μέρος του σώματος ή των ρούχων σας, κατά την επιθεώρηση ή την επισκευή.

- Αφαιρέστε τις βίδες ①. Αφαιρέστε το κάλυμμα ②.
- Ξεσφίξτε το μπουλόνι ③. Αφαιρέστε τον μεταλλικό σφιγκτήρα του σιγαστήρα ④.
- Αφαιρέστε το καπάκι του σιγαστήρα ⑤.
- Καθαρίστε την καπνιά που έχει κολλήσει στον σιγαστήρα με μια συρμάτινη βούρτσα.

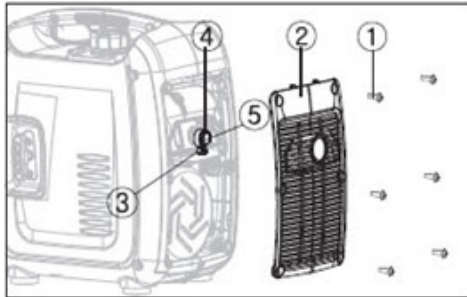

ΠΡΟΣΟΧΗ!

Κατά τον καθαρισμό, χρησιμοποιήστε τη συρμάτινη βούρτσα απαλά για να μην προκαλέσετε φθορές στον σιγαστήρα.

- Αν ο σιγαστήρας έχει φθορές/βλάβες, αντικαταστήστε τον.
- Τοποθετήστε ξανά το σιγαστήρα ⑤, το μεταλλικό σφιγκτήρα ④, το καπάκι ② και τις βίδες ①.

7.6 Φίλτρο ρεζερβουάρ καυσίμου



ΠΡΟΣΟΧΗ!

Μην χρησιμοποιείτε ποτέ βενζίνη όταν καπνίζετε ή κοντά σε ακάλυπτη φλόγα.

- Αφαιρέστε την τάπα του ρεζερβουάρ καυσίμου και το φίλτρο.
- Καθαρίστε το φίλτρο με βενζίνη και τοποθετήστε το ξανά.
- Κλείστε ξανά την τάπα του ρεζερβουάρ καυσίμου.

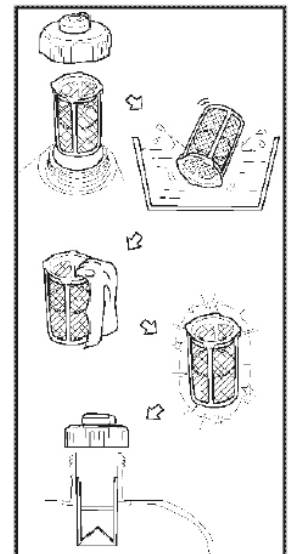

ΠΡΟΣΟΧΗ!

Βεβαιωθείτε ότι η τάπα του ρεζερβουάρ καυσίμου είναι σφιχτή.

8 ΑΠΟΘΗΚΕΥΣΗ

ΕΙΔΟΠΟΙΗΣΗ!

Εάν το μηχάνημα τεθεί σε λειτουργία για μεγάλο χρονικό διάστημα, θα χρειαστούν ορισμένες προληπτικές διαδικασίες για την προστασία του από φθορά.

8.1 Αποστράγγιση καυσίμου

- Γυρίστε τη στρόφιγγα καυσίμου στη θέση της «0» **CLOSE**.
- Αφαιρέστε την τάπα του ρεζερβουάρ καυσίμου και το φίλτρο. Βγάλτε το καύσιμο από το ρεζερβουάρ, βάζοντάς το σε ένα εγκεκριμένο δοχείο βενζίνης. Στη συνέχεια, τοποθετήστε ξανά την τάπα του ρεζερβουάρ καυσίμου.



ΠΡΟΣΟΧΗ!

Το καύσιμο είναι πολύ εύφλεκτο και τοξικό. Σκουπίστε αμέσως το χυμένο καύσιμο με ένα μαλακό, καθαρό, στεγνό πανί, επειδή θα μπορούσε να αλλοιώσει τις βαμμένες επιφάνειες ή τα πλαστικά μέρη.

ΕΙΔΟΠΟΙΗΣΗ!

Εκκινήστε τον κινητήρα και αφήστε τον να λειτουργήσει μέχρι να τελειώσει το υπόλοιπο καύσιμο. Μην συνδέετε ηλεκτρικές συσκευές· αυτή η λειτουργία πρέπει να γίνει χωρίς συνδέσεις. Η διάρκεια της λειτουργίας χωρίς συνδεδεμένες συσκευές, εξαρτάται από το καύσιμο που απομένει στο ρεζερβουάρ.

ΕΙΔΟΠΟΙΗΣΗ!

Καθαρίστε το εξωτερικό της Γεννήτριας. Αποθηκεύστε την σε στεγνό, καλά αεριζόμενο και προστατευμένο μέρος.

9 ΑΝΤΙΜΕΤΩΠΙΣΗ ΠΡΟΒΛΗΜΑΤΩΝ

ΠΡΟΣΟΧΗ!

Όλες οι έκτακτες εργασίες συντήρησης θα πρέπει να γίνονται από έναν τεχνικό μηχανικής συντήρησης.

ΠΡΟΒΛΗΜΑ	ΑΙΤΙΑ	ΛΥΣΗ
Ο κινητήρας δεν εκκινείται.	- Το ρεζερβουάρ δεν έχει καύσιμο. - Το ρεζερβουάρ έχει καύσιμο.	- Γεμίστε το ρεζερβουάρ καυσίμου. - Ελέγξτε τη θέση της βαλβίδας εξαερισμού, στην τάπα του ρεζερβουάρ (βλ. 4.9) Ελέγξτε τη θέση της στρόφιγγας καυσίμου (βλ. παρ. 4.1).
	Βουλωμένο καρμπυρατέρ.	Μεταφέρετε τη γεννήτρια σε εξουσιοδοτημένο κέντρο τεχνικής υποστήριξης του κατασκευαστή.
Χαμηλή στάθμη λαδιού κινητήρα (ανάβει η ενδεικτική λυχνία)	Λείπει λάδι.	Συμπληρώστε το λάδι στον κινητήρα (βλ. παρ. 5.2).
Ηλεκτρική/μηχανική δυσλειτουργία.	- Βρώμικο ή υγρό μπουζί. - Ελαττωματικό σύστημα ανάφλεξης.	- Καθαρίστε και στεγνώστε το μπουζί (βλ. παρ. 7.1). - Μεταφέρετε τη γεννήτρια σε εξουσιοδοτημένο κέντρο τεχνικής υποστήριξης του κατασκευαστή.
Η Γεννήτρια δεν παράγει ενέργεια.	- Συσκευή ασφαλείας (προστατευτική διάταξη DC) σε «OFF». - Η ενδεικτική λυχνία AC (πράσινη) σβήνει.	- Ρυθμίστε την προστατευτική διάταξη DC στο "ON". - Σταματήστε τον κινητήρα και μετά επανεκκινήστε τον

10 ΤΕΧΝΙΚΕΣ ΠΡΟΔΙΑΓΡΑΦΕΣ

Πρότυπο		1kW
Γεννήτρια	Τύπος	Αθόρυβος μετατροπέας
	Ονομαστική συχνότητα (Hz)	50/60
	Ονομαστική τάση (V)	110/120/220/230/240
	Ονομαστική ισχύς εξόδου (kW)	1,0
	Συντελεστής ισχύος	1
	Χωρητικότητα ρεζερβουάρ καυσίμου (L)	2,5
	Ποιότητα εξόδου AC	ISO8528 G2
	Τάση φόρτισης (DC) (V)	12
	Ρεύμα φόρτισης (DC) (A)	58.3
	Ισχύς (DC) (W)	700
	Προστατευτική διάταξη υπερφόρτωσης (DC)	Προστατευτική διάταξη χωρίς ασφάλειες τήξης
Κινητήρας	Κινητήρας	R60-i
	Τύπος μηχανής	Μονοκύλινδρος, 4χρονος, εξαναγκασμένη ψύξη αέρα, OHV
	Κυλινδρισμός (cc)	60
	Τύπος καυσίμου	Αμόλυβδη βενζίνη
	Συνεχής χρόνος λειτουργίας (στην ονομαστική ισχύ) (h)	4
	Χωρητικότητα λαδιού (L)	0,31
	Αρ. μοντέλου μπουζιού	ASRTC
	Λειτουργία εκκίνησης	Εκκίνηση αυτοεκτύλιξης
Γεννήτρια	Μήκος X πλάτος X ύψος (mm)	380×240×420
	Καθαρό βάρος (kg)	13

11 ΔΙΑΛΥΣΗ ΚΑΙ ΔΙΑΘΕΣΗ ΕΞΑΡΤΗΜΑΤΩΝ ΩΣ ΑΠΟΒΛΗΤΑ

11.1 Απόρριψη των εξαντλημένων υλικών

Το μηχάνημα μετά από την εγκατάσταση και κατά τη συνήθη λειτουργία του δεν ρυπαίνει το περιβάλλον, αλλά κατά τη συνολική διάρκεια χρήσης του οπωσδήποτε παράγονται ορισμένα είδη σκάρτων ή εξαντλημένων υλικών υπό ορισμένες προϋποθέσεις (για παράδειγμα, το γράσο λίπανσης των μηχανικών μερών).

Για την απόρριψη των υλικών αυτών υπάρχει σε κάθε χώρα συγκεκριμένη νομοθεσία για την προστασία του περιβάλλοντος. Είναι υποχρέωση του Πελάτη να γνωρίζει την ισχύουσα νομοθεσία της χώρας του και να ενεργεί με τρόπο που να πληροί αυτούς τους κανονισμούς, σύμφωνα με τις υποδείξεις που αναφέρονται στα τεχνικά δελτία των προϊόντων που χρησιμοποιούνται και που μπορούν να ζητηθούν από τον Κατασκευαστή.



ΠΡΟΣΟΧΗ!

Σας υπενθυμίζουμε την υποχρέωση τήρησης της ισχύουσας νομοθεσίας σχετικά με την απόρριψη των ορυκτελαίων ή των γράσων που χρησιμοποιούνται για τη λίπανση/συντήρηση.



ΠΡΟΣΟΧΗ!

Περισσότερες πληροφορίες σχετικά με τον τρόπο απόρριψης των λαδιών και των άλλων ουσιών υπάρχουν στο δελτίο ασφαλείας των ουσιών.

Η απόρριψη των τοξικών αποβλήτων κατά τις φάσεις της συλλογής, μεταφοράς, επεξεργασίας (υπό την έννοια της εργασίας μετατροπής αναγκαίας για την ανάκτηση), καθώς και η εναπόθεση και η υγειονομική ταφή των αποβλήτων στο έδαφος αποτελούν ενέργειες δημοσίου συμφέροντος που υπόκεινται στη συμμόρφωση των ακόλουθων γενικών αρχών:

- a) Πρέπει να αποφεύγεται κάθε ζημιά ή κίνδυνος για την υγεία, την ακεραιότητα και την ασφάλεια του συνόλου και του ατόμου.
- b) Πρέπει να εξασφαλίζεται η τήρηση των υγειονομικών απαιτήσεων και να αποφεύγεται κάθε κίνδυνος ρύπανσης του αέρα, του νερού, του εδάφους και του υπεδάφους.

Τα συστήματα ανάκτησης και ανακύκλωσης υλικών και ενέργειας πρέπει να προωθηθούν με την τήρηση οικονομικών και αποδοτικών κριτηρίων.

11.2 Ενδείξεις για ειδικά απόβλητα

Ειδικά απόβλητα είναι τα απορρίμματα που προέρχονται από βιομηχανικές επεξεργασίες και τα υλικά από τη διάλυση των εξοπλισμών και των χαλασμένων και πεπαλαιωμένων μηχανημάτων.

Κατά την απόρριψη των ειδικών αποβλήτων, ακόμη και των τοξικών ή βλαβερών, υποχρεούνται να φροντίσουν οι ίδιοι οι κατασκευαστές των αποβλήτων, απευθείας ή μέσω εξουσιοδοτημένων εταιρειών ή οργανισμών ή να τα παραδώσουν στους υπεύθυνους που διαχειρίζονται τη δημόσια υπηρεσία με τους οποίους έχει συναφθεί ειδική έγγραφη σύμβαση.

Κάθε χώρα/δήμος υποχρεούται να παρέχει στην περιφέρεια όλες τις πληροφορίες που διαθέτει σχετικά με την απόρριψη των αποβλήτων στο έδαφός τους.



ΠΡΟΣΟΧΗ!

Η καταχρηστική απόρριψη του προϊόντος από πλευράς του κατόχου επιφέρει διοικητικές κυρώσεις που προβλέπονται από την ισχύουσα νομοθεσία.



ΠΡΟΣΟΧΗ!

Σύμφωνα με την Οδηγία «ΑΗΗΕ» 2012/19 / ΕΕ, εάν το εξάρτημα/προϊόν που αγοράστηκε φέρει το ακόλουθο σύμβολο διαγραμμένου κάδου, σημαίνει ότι το προϊόν στο τέλος της ωφέλιμης ζωής του πρέπει να συλλέγεται χωριστά από άλλα απόβλητα .

Η ξεχωριστή συλλογή αυτού του συστατικού / προϊόντος στο τέλος της ζωής του οργανώνεται και διαχειρίζεται ο Κατασκευαστής. Ο χρήστης που θέλει να απαλλαγεί από αυτόν τον εξοπλισμό πρέπει επομένως να επικοινωνήσει με τον κατασκευαστή και να ακολουθήσει το σύστημα που έχει υιοθετήσει ο τελευταίος για να επιτρέψει την ξεχωριστή συλλογή του εξοπλισμού στο τέλος της ζωής του. Η δέουσα διαφοροποιημένη συλλογή για την επακόλουθη δρομολόγηση της διατιθέμενης συσκευής στην ανακύκλωση, στη επεξεργασία και στην διάθεση με περιβαλλοντικά συμβατό τρόπο, συντελεί στην αποφυγή ενδεχόμενων αρνητικών επιπτώσεων στο περιβάλλον και στην υγεία και ευνοεί την ανακύκλωση των υλικών από τα οποία αποτελείται το προϊόν. Η καταχρηστική απόρριψη του προϊόντος από πλευράς του χρήστη επιφέρει κυρώσεις που προβλέπονται από την ισχύουσα τοπική νομοθεσία.



RATO tarafından üretilen Campagnola Jeneratörü seçtiğinizi için teşekkürler.

Bu kılavuz onu nasıl kullanacağınız hakkında bilgiler içerir. Kullanmadan önce dikkatle okumanız rica edilir. Emin ve doğru biçimde kullanmak en iyi sonuçlar için size yardımcı olur.

Bu yayında geçen tüm bilgiler baskı anında mevcut en yeni ürünler hakkındaki bilgilere dayanırlar. Bu kullanma kılavuzunun içeriği revizyonlar veya diğer modifiyeler sebebiyle efektif parçalardan farklılık gösterebilir.

Firmamız, ön uyarı yapmadan ve hiçbir yükümlülük doğurmaksızın herhangi bir anda modifiyeler yapma hakkını saklı tutar. Bu yayının hiçbir bölümü firmamızın yazılı izni olmadan çoğaltılamaz.

Bu kullanma kılavuzu Jeneratörün kalıcı bir kısmı olarak görülmeli ve Jeneratöre satış durumunda dahi eşlik etmelidir.

GÜVENLİK İKAZLARI

UYARI!

Personelin, mülkünüzün ve diğerlerinin güvenliği çok önemlidir. Sembolün önündeki mesajları dikkatle okumanız rica olunur.

TEHLİKE!

Talimatlara uyulmadığı takdirde ÖLÜM ve ağır YARALANMALAR riski bulunur.

İKAZ!

Talimatlara uyulmadığı takdirde ÖLÜM ve ağır YARALANMALAR tehlikesi bulunur.

DİKKAT!

Talimatlara uyulmadığı takdirde YARALANMALAR tehlikesi bulunur.

UYARI!

Jeneratör veya diğer mülkler talimatlara uyulmaması durumunda hasar görebilir.

İÇİNDEKİLER

GÜVENLİK İKAZLARI	118
1 GÜVENLİK BİLDİRİMLERİ	120
2 ÖNEMLİ ETİKETLERİN KONUMLARI	122
3 TANIMI	123
3.1 Kontrol paneli	123
4 FONKSİYONLARIN KONTROLÜ	124
4.1 Yakıt valfi.....	124
4.2 Başlatma kolu.....	124
4.3 Yağ ikaz lambası (kırmızı)	124
4.4 Aşırı yük ikaz lambası (kırmızı).....	125
4.5 AC pilot ikaz lambası (yeşil).....	125
4.6 DC Koruma	125
4.7 Ana Şalter	125
4.8 Akıllı Şalter (C).....	126
4.9 Yakıt tankı tapası	126
4.10 Yakıt deposu tapası üzerine hava tahliye manivelası.....	126
4.11 Toprak terminali	126
5 HAZIRLIK	127
5.1 Yakıt	127
5.2 Yakıt İkmali.....	127
5.3 Motor yağı	127
5.4 KULLANIM ÖNCESİ TETKİK.....	128
6 İŞLEYİŞİ	128
6.1 Motor çalıştırma	128
6.2 Motor durdurma	129
6.3 Alternatif akımda bağlantı (AC).....	129
6.4 Uygulama alanı	130
7 BAKIM	131
7.1 Buji muayenesi.....	132
7.2 Karbüratör düzenleme	132
7.3 Motor yağının değiştirilmesi	132
7.4 Hava filtresi	132
7.5 Susturucu siperi ve kıvılcım paravanı	133
7.6 Yakıt tankı filtresi.....	133
8 SAKLAMA	134
8.1 Yakıt boşaltma	134
9 PROBLEMLERİN ÇÖZÜMÜ	134
10 TEKNİK ÖZELLİKLER	135
11 PARÇALARIN SÖKÜLMESİ VE TASFİYESİ	135
11.1 Tükenmiş malzemelerin tasfiyesi	135
11.2 Özel atıklarla ilgili talimatlar	136

1 GÜVENLİK BİLDİRİMLERİ

Jeneratörü işleme almadan önce bu kullanma kılavuzunu okuyun ve anlayın. Jeneratörün güvenli işletim prosedürlerinin bilinmesi olası kazaların önlenmesinde sizlere yardımcı olacaktır.

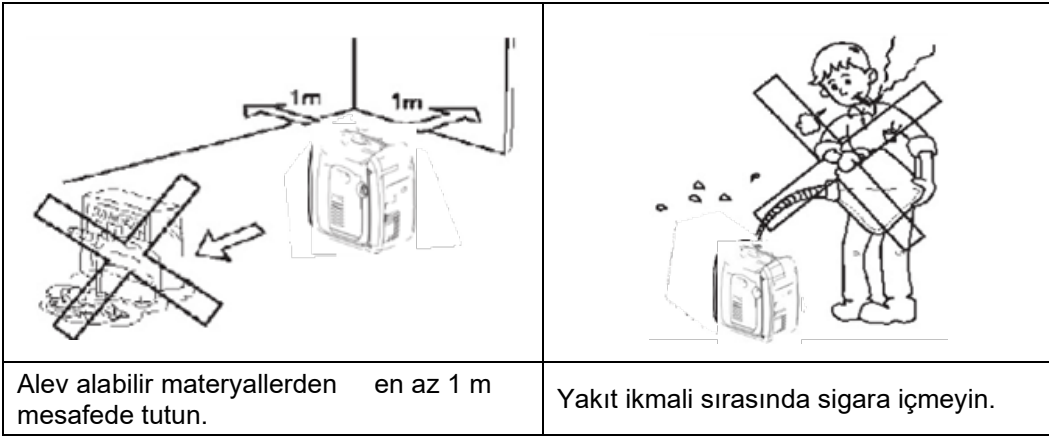
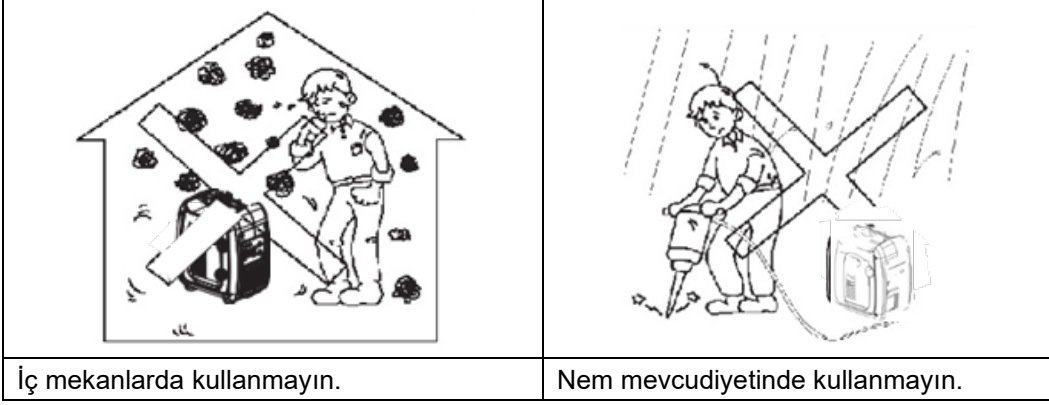

⚠ UYARI!

Ev tipi elektrik güç kaynağına bağlantı.

Eğer jeneratör ev tipi bir güç kaynağına bağlanacaksa, bağlantı profesyonel bir elektrikçi ya da uygun elektrik uzmanlığına sahip bir kişi tarafından yapılmalıdır.

Yükler Jeneratöre bağlandığında elektrik bağlantılarının emin ve güvenilir olduğunu dikkatle doğrulayın. Uygunsuz bir bağlantı Jeneratöre hasar verebilir veya bir yangına neden olabilir.

⚠ TEHLİKE!

Jeneratör bir akü şarj cihazı DEĞİLDİR ve sağlanan akım için herhangi bir kontrol ve koruma sistemi ile donatılmadığından bu amaç için kullanılamaz.

Akü şarj cihazı olarak kullanılması ÜRETİCİ TARAFINDAN İZİN VERMEZ VE YASAKLANMAZ, tehlikelidir ve aküye, jeneratöre zarar verebilir, yangın durumunda ciddi yaralanmalara neden olabilir.

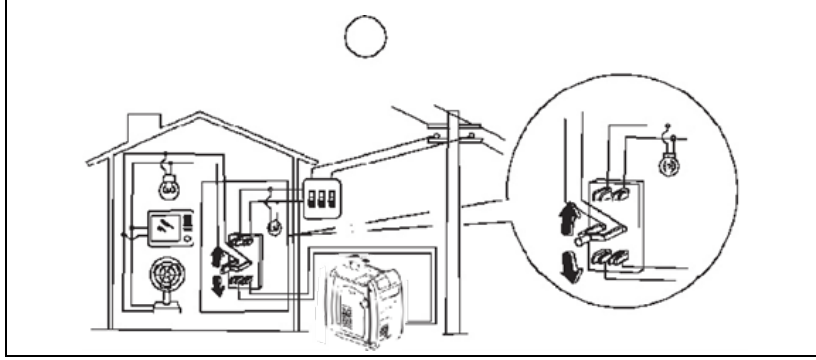
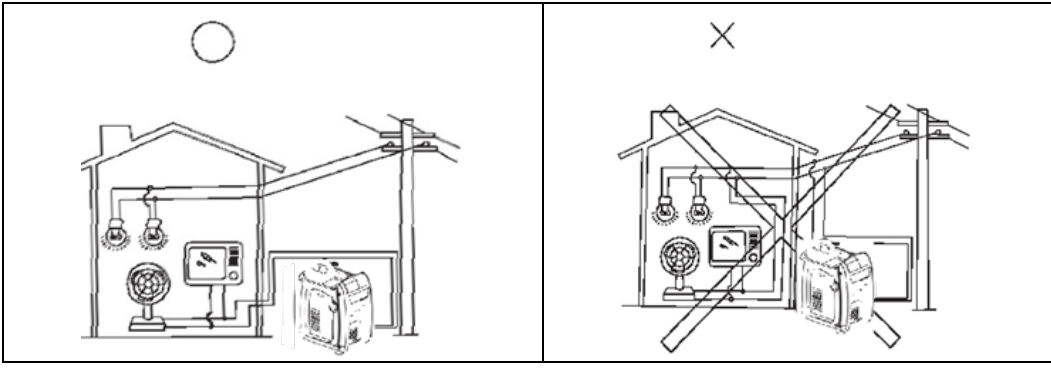

Jeneratörün toprak bağlantı devresi

Yetersiz elektrik cihazlarına veya elektriğin hatalı kullanımına bağlı elektrik çarpmalarına karşı, Jeneratör iyi kaliteli bir izole iletken ile toprağa bağlanmalıdır.

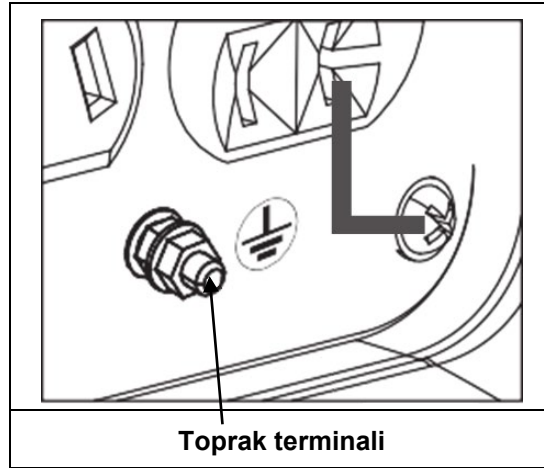

! UYARI!

Kontrol paneli, havalandırma ve invertörün alt kısmının iyice soğuduklarından ve kir, çamur ve su olmadığından emin olun. Soğutma hava tahliyesinin bloke olması durumunda, motor, invertör veya alternatör hasar görebilirler.

Jeneratörü, taşınma, dinlenmeye alınma veya ünitenin işleme alınması durumunda diğer objeler ile birlikte yığmayın. Bu Jeneratörde hasarlara neden olabilir ya da Jeneratör sızıntı yaparsa mülkün güvenliğine zarar verebilir.

2 ÖNEMLİ ETİKETLERİN KONUMLARI





DİKKAT!

Bu makineyi kullanmadan önce aşağıdaki tabloları dikkatle okuyun.

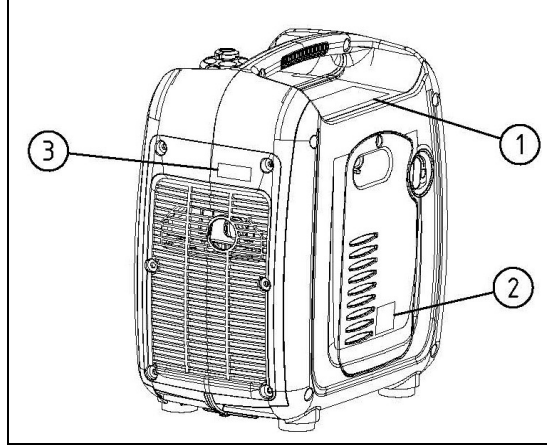
TAVSİYE: Eğer gerekirse, talimatlar ve güvenlik etiketlerini tutun veya değiştirin.



 WARNING	
1	<ul style="list-style-type: none">● Read the owner's manual and all labels before operating.● Only operate in well-ventilated areas. Exhaust gas contains poisonous carbon monoxide.● Check for spilled fuel or fuel leaks.● Stop engine before refueling.● Do not operate near flammable materials.● Electrocutation can occur if generator is used in rain, snow, or near water. Keep this unit dry at all times.● Electrocutation or property damage can occur. Do not connect this generator to any building's electrical system unless an isolation switch has been installed by a licensed electrician. Refer to the owner's manual.● When operating the generator:<ul style="list-style-type: none">Never place a partition or other barrier around the generator.Do not cover the generator with a box.Do not place any objects on the generator.● Turn the fuel tank cap air vent knob to "OFF" after the engine has completely cooled down.
2	
3	

3 TANIMI

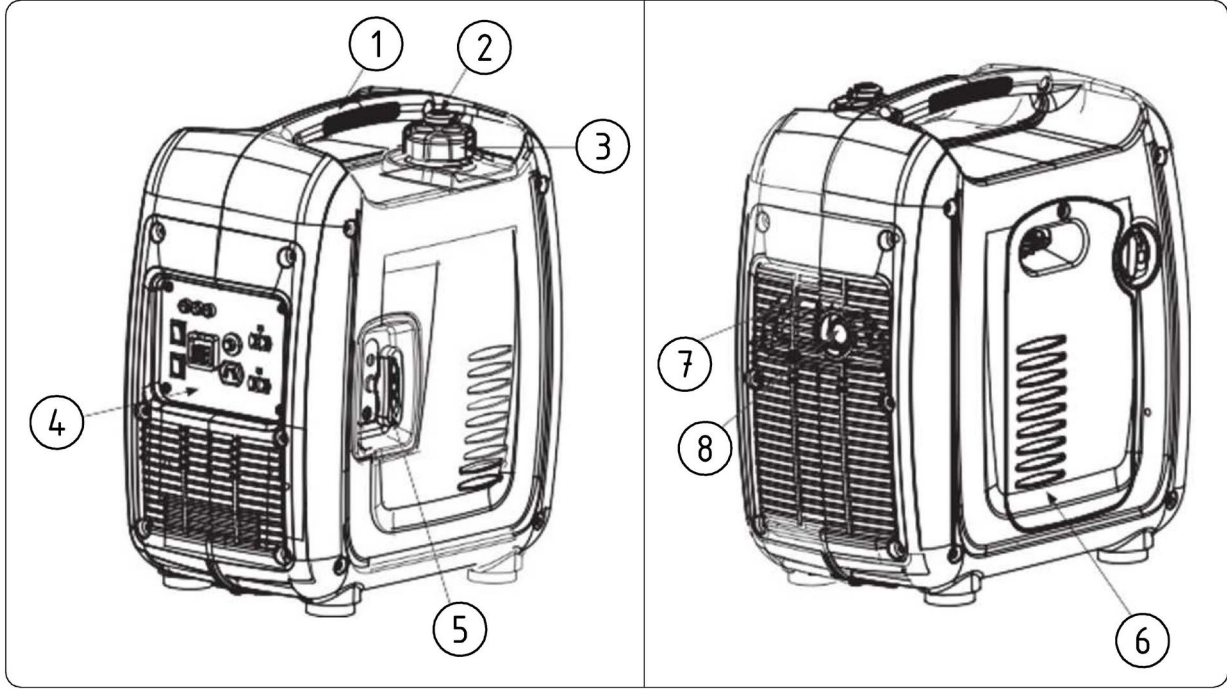

Poz.	Adı
1	Taşıma kolu
2	Yakıt deposu tapası üzerine hava tahliye manivelası
3	Yakıt tankı tapası
4	Kontrol paneli
5	Çekme ipli marş
6	Yağ dolum tapası
7	Havalandırma
8	Susturucu

3.1 Kontrol paneli

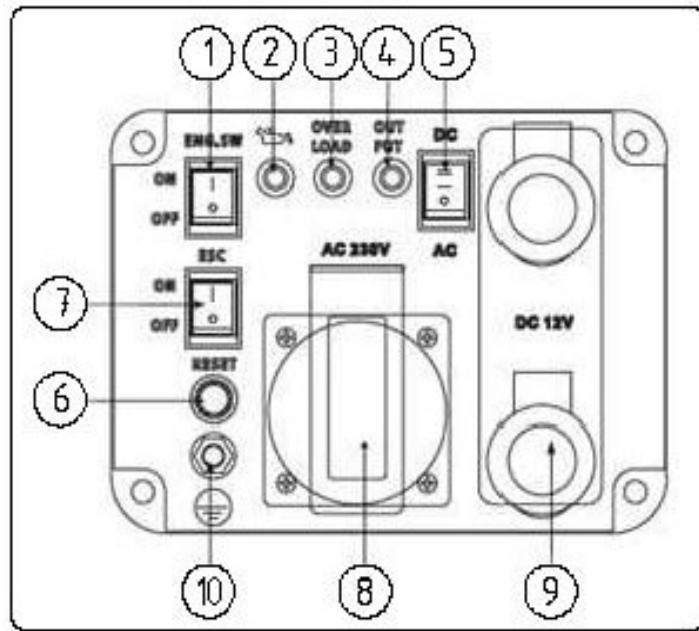

Poz.	Adı
1	Ana Şalter
2	Yağ göstergesi
3	Aşırı yük ikaz lambası
4	AC pilot ikaz lambası
5	Düğme AC/DC (AC Alternatif akım, DC Doğru akım)
6	AC Resetleme
7	ESC (Motor akıllı kontrolü)
8	AC prizi
9	Bağlantılar (+/-) DC
10	Toprak Terminali

4 FONKSİYONLARIN KONTROLÜ

4.1 Yakıt valfi

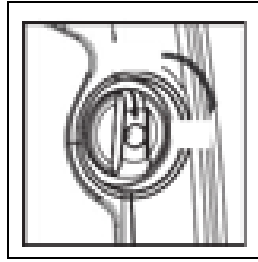

Yakıt valfi depodan karbüratöre yakıt akışını kontrol eder. Motoru kapattıktan sonra kolu "OFF" üzerine getirdiğinizden emin olun.

4.2 Başlatma kolu

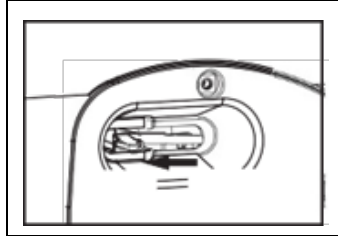

Başlatma kolu, soğuk bir motor ateşlenirken zenginleştirilmiş bir yakıt karışımı sağlamaya yarar. Başlatma kolunu yavaşça "AÇIK" üzerine getirdikten sonra motor başlatılacaktır.

TAVSİYE: Starter sıcak bir motoru başlatmak için gerekli değildir.

4.3 Yağ ikaz lambası (kırmızı)



Yağ seviyesi minimum altına indiğinde ikaz lambası ① yanar, motor otomatik olarak durur. Eğer yağ seviyesi düzeltilmezse motor tekrar çalışmaz.

TAVSİYE: Eğer motor bloke olursa ya da çalışmazsa, motor düğmesini "ON" üzerine getirin ve ipli marşı çekin. Eğer yağ ikaz lambası birkaç saniye yanıp sönerse, motor yağının yetersiz olduğu anlamına gelir. Yağ ilave edin ve motoru çalıştırın.

4.4 Aşırı yük ikaz lambası (kırmızı)

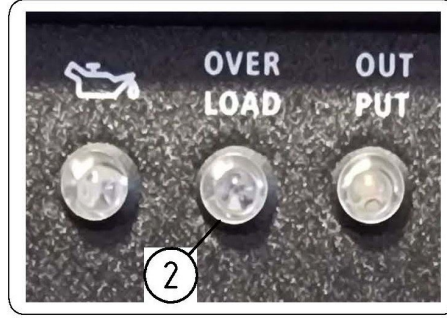

Aşırı yük ikaz lambası ② bağlı bir elektrik cihazının aşırı yükü saptandığında yanar, inverter ünitesi aşırı ısınır veya AC çıkış gerilimi artar. Ardından AC koruma Jeneratörü veya bağlı diğer elektrikli cihazları korumak için enerji yaratımını keserek devreye girer. Pilot AC ikaz lambası (yeşil) yanar ve aşırı yük ikaz lambası (kırmızı) açık kalır fakat motor durmaz.

Aşırı yük ikaz lambası yandığında elektrik enerjisi üretimi durduğunda, aşağıdaki gibi ilerleyin:

1. Bağlı tüm elektrik cihazlarını kapatın ve motoru durdurun.
2. Bağlı elektrik cihazlarının total gücünü nominal güç aralığına indirin.
3. Soğutma havası girişinde ve kontrol ünitesi etrafında tıkanma olmadığını kontrol edin, bloklar ile karşılaşırsa bunları temizleyin.
4. Kontrol ettikten sonra motoru çalıştırın.

Tavsiye: Aşırı yük ikaz lambası, büyük bir başlatma akımı gerektiren elektrik cihazları kullanıldığında, örneğin bir kompresör veya daldırılmalı bir pompa gibi, başlangıçta birkaç saniye yanabilir. Bu bir çalışma bozukluğu olduğunu göstermez.

4.5 AC pilot ikaz lambası (yeşil)

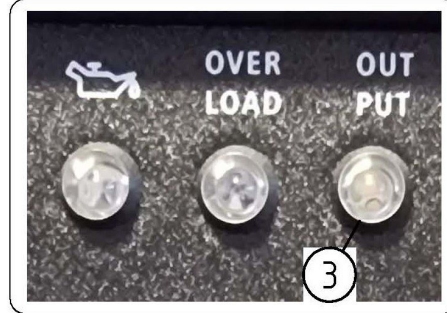

AC pilot ikaz lambası ③ motor çalıştığında ve güç ürettiğinde yanar.

4.6 DC Koruma

4.7 Ana Şalter

① - **On:** Jeneratörü başlatır

② - **Off:** Jeneratörü Durdur

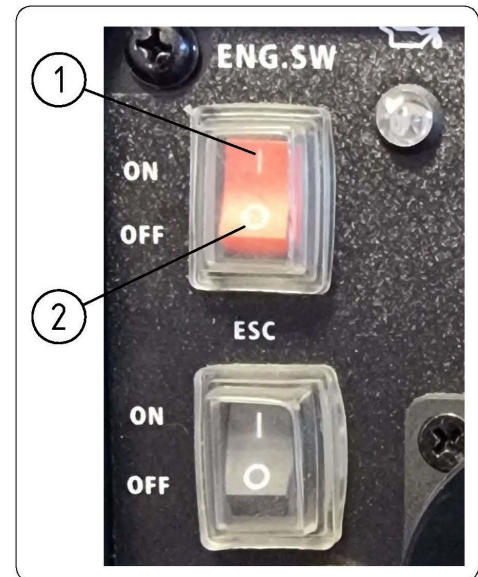

4.8 Akıllı Şalter (C)

Eğer etkin kılınmışsa akıllı fonksiyon (şalter 1 "ON" üstünde) motorun yükün olmadığı ve az olduğu koşullarda düşük yakıt tüketimi ile minimumda dönmesini sağlar; yükün artması ile daha fazla güç tedariki için motor devirleri de artar.

Akıllı fonksiyon etkisiz bırakıldığında (şalter 0 "OFF" üstünde) motor derhal maksimum güç tedarik etmek için hep maksimum devirdedir, bu fonksiyon büyük başlangıç emişli elektrik aletlerini çalıştırmak gerektiğinde faydalıdır.



4.9 Yakıt tankı tapası

Yakıt tankı tapasını saatin aksi yönünde çevirerek çıkarın.

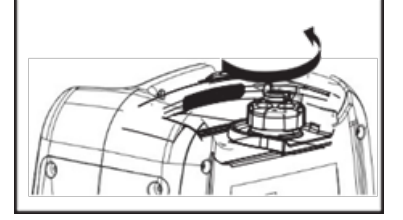

4.10 Yakıt deposu tapası üzerine hava tahliye manivelası

Yakıt tankı tapası ② yakıt akışını durdurmak için bir tahliye manivelası ① ile donatılmıştır.

Hava tahliye manivelası "ON" üzerinde olmalıdır. Bu yakıtın karbüratörde ve motorda akışını sağlar.

Motor kullanılmadığında yakıt akışını durdurmak için hava tahliye manivelasını "OFF" üstüne getirin.

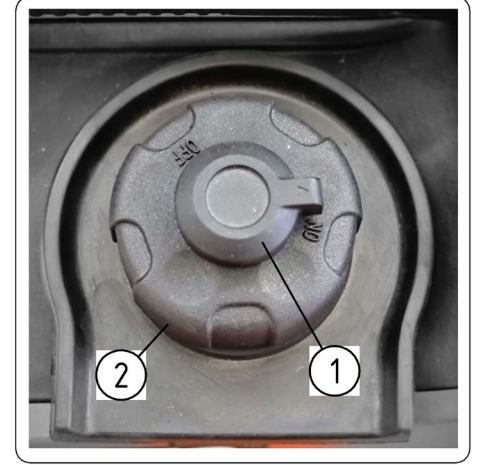

4.11 Toprak terminali

Toprak terminali ①



DİKKAT!

Yalnız 220 V alternatif akımlı şebekeye bağlı Jeneratör kullanılıyorsa bağlanmalıdır.



5 HAZIRLIK

5.1 Yakıt



DİKKAT!

Yakıt yüksek tutuşma özelliğine sahiptir ve zehirlidir. İkmal öncesinde “GÜVENLİK BİLGİLERİ” bölümünü dikkatle okuyun.

- Yakıt tankını aşırı derecede doldurmayın, aksi halde yakıt ısındığında taşabilir ve yayılabilir.
- Yakıt tankını doldurduktan sonra, yakıt tankı tapasının iyice sıkıldığından emin olun.



UYARI!

- Dökülen yakıtı derhal yumuşak, temiz bir bez ile temizleyin, yoksa yakıt cilalı yüzeyler veya plastik kısımları bozabilir.
- Sadece kurşunsuz benzin kullanın. Kurşun ihtiva eden benzin kullanımı motorun iç kısımlarında ağır hasarlar açar.

5.2 Yakıt İkmal



DİKKAT!

Yakıt yüksek tutuşma özelliğine sahiptir ve zehirlidir. İlk ikmal öncesinde “GÜVENLİK BİLGİLERİ” bölümünü dikkatle okuyun.

- Yakıt tankını aşırı derecede doldurmayın, aksi halde yakıt ısındığında taşabilir ve yayılabilir.
- Yakıt tankını doldurduktan sonra, yakıt tankı tapasının iyice sıkıldığından emin olun



DİKKAT!

- Dökülen yakıtı derhal yumuşak, temiz bir bez ile temizleyin, yoksa yakıt cilalı yüzeyler veya plastik kısımları bozabilir.
- Sadece kurşunsuz benzin kullanın. Kurşun ihtiva eden benzin kullanımı motorun iç kısımlarında ağır hasarlar açar.



UYARI!

İkmal yapmak için, yakıt tankı tapasını çıkarın ve tankı kırmızı seviyeye ① kadar doldurun.

Önerilen yakıt:

Kurşunsuz benzin

Yakıt tankı kapasitesi:

Total: 2.5L

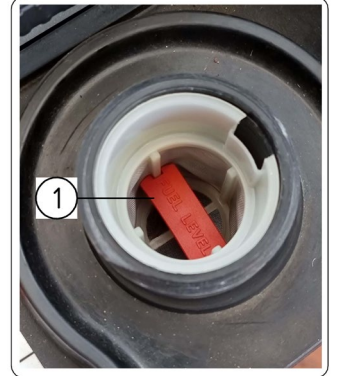

5.3 Motor yağı



DİKKAT!

Jeneratör motor yağsız gönderilir. Motoru, yeterli miktarda motor yağı ile doldurulana kadar çalıştırmayın.



- Jeneratörü düz bir yüzey üzerine yerleştirin.

- Vidaları çıkartın ① , ardından kapağı ② çıkartın.
- Yağ dolum tapasını ③ çıkartın.
- Tavsiye edilen yağdan belirtilen miktarda doldurun ve yağ tapasını ③ kapatın.
- Kapağı ② yerine takın, vidaları ① sıkın.

Önerilen motor yağı:	SAE SJ 15W-40
Önerilen motor yağı derecesi:	API Service SE tipi veya yüksek kalitelisi
Motor yağı miktarı:	0.31 L

5.4 KULLANIM ÖNCESİ TETKİK



UYARI!

- Jeneratörü çalıştırmadan önce tüm kısımlarının sağlam olduğunu doğrulayın, eğer hasarlı ise işletmeden önce bunları tamir ettirin, Jeneratör kullanılması dahi hayati aksamlar hızla ve beklenmedik biçimde bozulabilirler.
- Bir Jeneratörün koşullarının tetkiki sahibine ait bir sorumluluktur.
- Kullanım öncesi kontroller Jeneratörün her kullanımı öncesi yapılmalıdır.
- Kullanmadan önce **Yakıt** (bakınız par. 5.2) seviyesini tetkik edin, eğer gerekiyorsa ilave edin.
- Kullanmadan önce **Motor yağı** (bakınız par. 5.3)seviyesini kontrol edin, eğer gerekiyorsa ilave edin.
- Kullanmadan önce Jeneratörde yağ sızıntısı olmadığını kontrol edin.

İzleyen kullanım kılavuzunda belirtilmeyen anormallikler durumunda yetkili bir servise danışın.

6 İŞLEYİŞİ



DİKKAT!

Motoru asla, tahliye gazları bilincinizin kapanmasına ve kısa sürede hayatınızı kaybetmenize neden olabileceğinden, kapalı bir alanda çalıştırmayın. Motoru çok iyi havalandırılan bir alanda çalıştırın.

- Jeneratör çalıştırılmadan önce, hiçbir elektrik cihazı bağlamayın.
- Jeneratör motor yağı olmadan gönderilir, belirtilen miktar ile doldurulana kadar motor çalıştırmayın (bakınız par. 5.3).
- Motor yağı ilave edilirken Jeneratörü eğmeyin, bu aşırı doluma neden olarak motora hasar verebilir.
- Jeneratör standart atmosfer koşullarında çıkışta nominal yük ile kullanılabilir:
 - Ortam sıcaklığı: 25°C
 - Barometrik basınç: 100kPa
 - Bağıl nem: %30.
- Jeneratör gücü sıcaklık değişimi, yükseklik (hava basıncı yüksek mevkilerde daha alçaktır) ve neme göre değişir.
- Jeneratör gücü, sıcaklık, nem ve yükseklik standart atmosfer koşullarının üzerindeyse azalır.
- Yük, dar alanlarda kullanıldığında azaltılmalıdır çünkü Jeneratör soğutması bundan etkilenir.

6.1 Motor çalıştırma

- 1- Tahliye manivelasını "On" ① üzerine getirin

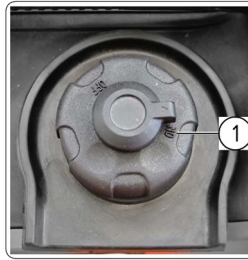

- 2- Yakıt musluğunu ② ise A pozisyonuna getirin;
- 3- Starter kolunu ③ B konumuna getirin;

Jeneratör başlatılmaya hazırdır.



! UYARI!

Jeneratörü sıcak motor ile başlatmak için starter kolu "OPEN" üzerinde kalmalıdır.

- 4- Geri tepmeli çalıştırma kolunu ② takılana kadar yavaşça çekin, ardından motoru çalıştırmak için hızlıca çekin.



! DİKKAT!

Taşıma kolunu sıkıca kavrayarak ① Jeneratörün geri tepmeli başlatma çekilirken düşmesine engel olun.

- 5- Motorun birkaç dakikalık çalışması ardından starter kolunu **OPEN** pozisyonuna getirin.

6.2 Motor durdurma

! UYARI!

- Motoru durdurmadan önce bağlı tüm elektrik cihazlarını kapatın.
- Jeneratör düğmesini "OFF" pozisyonuna getirin (bakınız par. 4.7).
- Yakıt musluğunu "0" **CLOSE** pozisyonuna çevirin.

Çalıştırma devresi kapalıdır, yakıt kapalıdır.



- Motor tamamen soğuduktan sonra hava tahliye manivelasını "OFF" - 1 üzerine çevirin.



6.3 Alternatif akımda bağlantı (AC)

! DİKKAT!

- Tüm elektrik cihazlarının Jeneratöre bağlanmadan önce kapatılmış olduklarından emin olun.
- Tüm elektrik cihazlarının kablolar ve fişli konektörler dahil Jeneratöre bağlanmadan önce iyi durumda olduklarından emin olun.
- Total yükün Jeneratörün nominal gücüne girdiğinden emin olun.
- Prizin yük akımının priz nominal akımına girdiğinden emin olun.

NOT: eğer Jeneratör 220 V alternatif akım şebekesine bağlı ise Jeneratör de toprağa Toprak terminali ile bağlanmış olmalıdır (bakınız par. 4.11).

**DİKKAT!**

12 V aletler kullanıldığında akıllı şalter “ESC” (bakınız par. 4.8) kesinlikle 1 “ON” pozisyonunda olmalıdır).

6.4 Uygulama alanı**DİKKAT!**

Jeneratör kullanıldığında total yükün Jeneratörün nominal gücüne girdiğinden emin olun. Aksi halde Jeneratörde hasarlar görülebilir.

AC				DC
Güç faktörü	1	0.8- 0.95	0.4-0.75 (Verim 0,85)	
lkW	<=1 000W	<=800W	<=400W	Nominal gerilim 12 V

**DİKKAT!**

- Uygulama gücü her cihazın tek başına kullanıldığı zamanı gösterir.

ÖRNEK:

Jeneratör çıkışında nominal güç		1.000 w
Frekans	Güç faktörü	
AC	1,0	<= 1.000W
	0,8	<= 800W
DC	---	700W(12Vx58.3A)

**DİKKAT!**

Aşırı yük ikaz lambası ② total güç plaka verilerini aştığında (bakınız böl. 10) yanar.

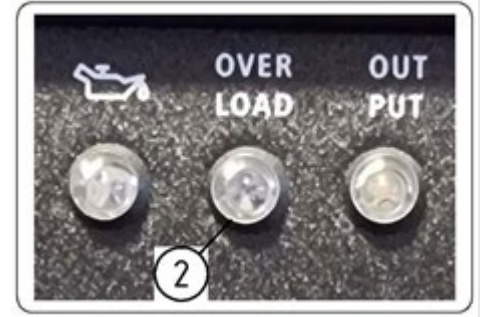
**DİKKAT!**

- Aşırı yüklemeyin, bağlı tüm elektrikli cihazların total yükü Jeneratör veri plakasını aşmamalıdır. Bir aşırı yükleme Jeneratöre hasar verir.
- Hassasiyet teçhizatları, elektronik kontrol cihazları, PC, elektronik bilgisayarlar, mikrobilgisayarlar veya batarya şarj bazlı donanımlar beslendiğinde Jeneratörü elektrik parazitlerini önlemek için yeterli bir mesafede tutun. Ayrıca Jeneratörün yaydığı frekansın bunun yakınında duran diğer elektrikli ve elektronik cihazlar ile parazite neden olmadığından emin olun.
- Eğer Jeneratör tıbbi cihazları besleyecekse, ilk önce üreticisine veya sağlık sektöründen bir uzmana danışmak gereklidir.
- Bazı elektrikli cihazlar veya genel elektrik motorları yüksek başlatma akımına sahiptir ve bu yüzden önceki tabloda verilen besleme aralıklarına dahil olmalarına rağmen kullanılamazlar. Daha fazla tavsiye için cihazın üreticisine danışın.

7 BAKIM



DİKKAT!

- Herhangi bir rutin operasyon yapmadan önce Jeneratörü durdurun.
- İş bu kılavuzda bulunmayan tüm bakım işlemleri yetkili teknik servis merkezlerinde gerçekleştirilmelidir.



Rutin bakım işlemleri operatörler tarafından yapılabilir.



DİKKAT!

- Motor, emin, ekonomik problemsiz ve ekolojik bir işleyiş garantileyebilmek için uygun bir bakımdan geçirmiş olmalıdır.
Benzinli motorun, mükemmel çalışma koşullarını muhafaza etmesi için periyodik bakımdan geçirilmesi gerekir. Mütekip bakım programı ve rutin muayene prosedürlerini dikkatle takip etmek gerekir:

Aksam	Frekans	Her seferinde	İlk ay veya ilk 20 saatlik işleyiş	Akabinde, her 3 ay veya her 50 saatlik işleyiş	Her yıl veya her 100 saatlik işleyiş
Motor yağı	Kontrol - Dolum	✓			
	Değiştirme		✓	✓	
Hava filtresi	Kontrol	✓			
	Temizlik		✓		
	Değiştirme			✓	
Ateşleme bujisi	Kontrol-düzenleme				✓
	Değiştirme	Her yıl veya her 250 saatlik işleyiş			
Kıvılcım paravanı	Temizlik				
Minimumda işleyiş (donanımda ise) *	Kontrol-düzenleme				✓
Tank ve yakıt filtresi *	Temizlik				✓
Yakıt borusu	Kontrol	Her 2 yılda (gerekli ise değiştirin)			

* Bu aksamlar yetkili satış bayimiz tarafından bakılmalı ve tamir edilmelidir.



DİKKAT!

- Bakım yapmaya başlamadan önce motoru durdurun. Motoru düz bir yüzeye yerleştirin ve buji kepini motorun çalışmasına engel olmak için çıkarın.
Motoru az havalandırılan bir mekanda veya kapalı bir bölgede çalıştırmayın. Çalışma alanında iyi bir havalandırma sağlandığından emin olun. Motorun tahliye gazları zehirli CO içerir, bunun teneffüs edilmesi şok, bilinç kaybı ve hatta ölüme neden olabilir



DİKKAT!

- Eğer benzinli motor sıklıkla yüksek sıcaklıklarda veya ağır yükler ile çalışıyorsa her 25 saatte bir yağı değiştirin.
- Eğer motor tozlu ve başka ağır koşullarda sıklıkla çalışıyorsa filtreleyici elemanı her 10 saatte bir temizleyin. Eğer gerekli ise hava filtreleyici elemanı her 25 saatte bir değiştirin.
- Belirtilen bakım periyodlarına uyun.
- Motorun bakımı için öngörülen zaman aşımına uyulmaz ise en kısa zamanda uygulayın.

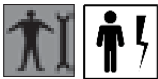

YETKİLİ ATÖLYE

Satıcılarımız tarafından tavsiye edilen ve ürünlerin onarım işlemlerini gerçekleştirmeye yetkili atölyedir.

7.1 Buji muayenesi



DİKKAT!

Buji motorun önemli bir aksamıdır ve periyodik olarak kontrol edilmelidir.

1. Kapağı kaldırın ①, buji tapasını kaldırın ②; Jeneratörün donanımında verilen anahtar ile saatin aksi yönünde çevirerek bujiyi sökün.
2. Kömürümsü kalıntıların olmadığını kontrol edin varsa çelik bir fırça yardımı ile temizleyin.
3. Bujinin belirtilen modele karşılık geldiğini kontrol edin; standart buji **A5RTC**

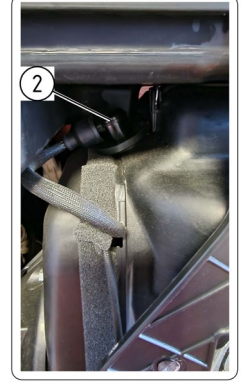
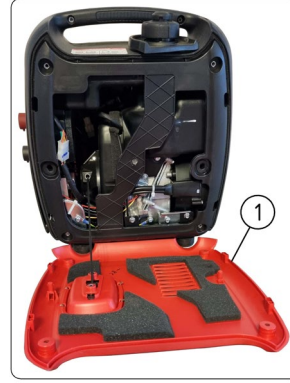

4. Elektrodlar arasındaki mesafeyi bir mastar yardımı ile doğrulayın: 0,6-0,8 mm.
5. Bujiyi 12,5 Nm sıkma torqu ile yeniden monte edin
6. Buji tapasını ② ve kapağı ① monte edin.

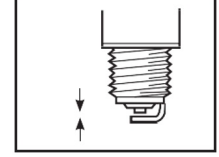

7.2 Karbüratör düzenleme



DİKKAT!

Karbüratör motorun önemli bir aksamıdır, bakımı ve düzenlenmesi yetkili bir teknik servis tarafından yapılmalıdır.

7.3 Motor yağının değiştirilmesi



DİKKAT!

- Motorun henüz durdurulması ardından hemen motor yağını boşaltmaktan kaçının. Yağ sıcaktır ve yanıkları önlemek için özenle tutulmalıdır.
- Yağ değişimi için Paragraf 5.3. referans alınacaktır.



DİKKAT!

Jeneratörü motor yağı ilave edilirken eğmeyin. Bu aşırı bir dolum ve motor hasarlarına neden olabilir.

7.4 Hava filtresi

- Jeneratörü düz bir yüzey üzerine yerleştirin.
- Vidaları çıkarın ①, kapağı kaldırın ②.
- Filtre kapağını ③ çıkartın.
- Filtreyi ③ çıkartın.
- Elemanı nötr bir sabun ve sünger ile yıkayın ve kurulayın.
- Sünger elemanı yağlayın ve fazla yağı temizleyin. Sünger eleman nemli olmalıdır, damlamamalıdır.



DİKKAT!

Bu operasyon sırasında süngeri sıkmayın. Yırtilabilir.

- Sünger elemanı hava filtresi gövdesine, sünger elemanın sızdırmazlık yüzeyinin hava sızıntılarına engel olacak şekilde hava filtresini sardığına emin olarak takın.



DİKKAT!

Motor sünger elemansız asla çalışmamalıdır; piston ve silindirin fazla aşınmasına neden olur.

- Hava filtresinin gövde kapağını ③ orijinal konumuna monte edin.
- Kapağı ② yerine takın ve vidaları ① sıkın.

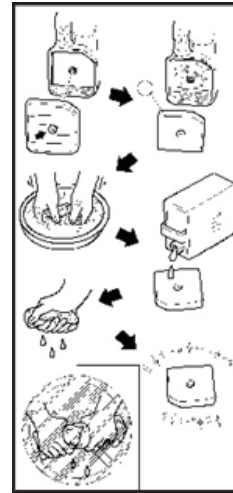

7.5 Susturucu siperi ve kıvılcım paravanı



DİKKAT!

Motor ve susturucu motorun işleyişi ardından çok sıcak olabilir. Motor ve susturucuya hala sıcakken muayene veya onarım sırasında vücudunuz veya giysileriniz ile dokunmaktan kaçınınız.

- Vidaları ① çıkarın, kapağı ② çekin.
- Somunu ③ gevşetin susturucunun metal şeridini ④ çıkarın.
- Susturucu kepini ⑤ çıkarın.
- Susturucu üzerinde mevcut olası karbon kalıntılarını metal bir fırça ile temizleyin.

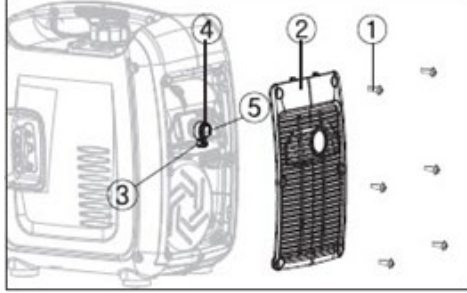

DİKKAT!

Temizlik sırasında metal fırçayı susturucuya zarar vermemek için nazikçe kullanınız.

- Eğer susturucu hasarlı ise yenisi ile değiştirin.
- Susturucuyu ⑤, metal şerit ④, kapak ② ve vidaları ① monte edin.

7.6 Yakıt tankı filtresi



DİKKAT!

Sigara içildiğinde veya serbest alev yakınındayken asla benzin kullanmayınız.

- Yakıt tankı tapası ve filtresi çıkarınız.
- Filtreyi benzin ile temizleyiniz ve monte edin.
- Yakıt tankı tapasını yeniden kapatınız.



DİKKAT!

Yakıt tankı tapasının iyice sıkı olduğundan emin olunuz.

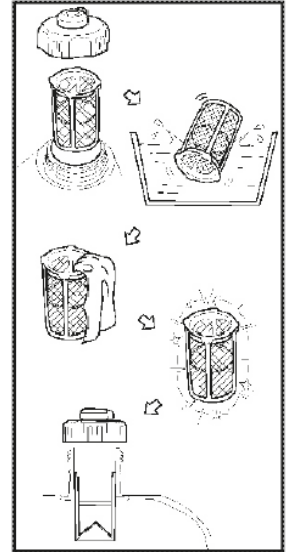

8 SAKLAMA



UYARI!

Eğer makine uzun bir süre için dinlenmeye alındıysa bozulmadan korunması için bazı önleyici prosedürlerin uygulanması gerekir.

8.1 Yakıt boşaltma

- Yakıt musluğunu "0" CLOSE pozisyonuna çevirin.
- Yakıt tankı tapası ve filtreyi çıkarın. Yakıtı tanktan onaylı bir benzin bidonuna aktararak boşaltın. Ardından, yakıt tankı tapasını yeniden kapatın.



DİKKAT!

Yakıt yüksek derecede alev alabilir ve zehirli bir maddedir, dökülen yakıtı derhal yumuşak, temiz bir bez ile temizleyin, yoksa yakıt cilalı yüzeyler veya plastik kısımları bozabilir



UYARI!

Motoru çalıştırın ve kalan yakıt bitene kadar dönmeye bırakın, elektrikli cihazlar bağlamayın, bu operasyon boşken yapılacaktır. Boş işleme süresi tankta kalan yakıt miktarına göre değişir.



UYARI!

Jeneratörün dışını temizleyin, kuru, iyi havalandırılan ve korunaklı bir mekanda saklayın.

9 PROBLEMLERİN ÇÖZÜMÜ



DİKKAT!

Bütün özel bakım işlemleri mekanik bakım teknisyeni tarafından yapılmalıdır.

SORUN	NEDENİ	ÇÖZÜMÜ
Motor çalışmıyor.	- Tankta yakıt yok. - Tankta yakıt var.	- Yakıt tankını doldurun. - Tank tapası üzerindeki tahliye vanasının pozisyonunu doğrulayın (bkz par. 4.9) Yakıt musluğunun konumunu doğrulayın (bkz par. 4.1).
	Karbüratör tıkalı.	Jeneratörü Üreticinin Yetkili Teknik Servisine götürün.
Motor yağı seviyesi düşük (ikaz lambası yanar)	Yağ eksik.	Motora yağ doldurun (bkz par. 5.2).
Elektrik/mekanik hatalı işleyiş.	- Buji kirli ya da ıslak. - Ateşleme sistemi defolu.	- Bujiyi temizleyin ve kurulaştırın (bkz par. 7.1). - Jeneratörü Üreticinin Yetkili Teknik Servisine götürün.
Jeneratör enerji üretmiyor.	- Güvenlik cihazı (DC koruması) "OFF" üzerinde. - AC pilot ikaz lambası (yeşil) söner.	- DC korumasını "ON" üzerine getirin. - Motoru kapatın ve tekrar çalıştırın.

10 TEKNİK ÖZELLİKLER

Modeli		1kW
Jeneratör	Türü	Sessiz invertör
	Nominal Frekans (Hz)	50/60
	Nominal gerilim (V)	110/120/220/230/240
	Nominal çıkış gücü (kW)	1,0
	Güç faktörü	1
	Yakıt tankı kapasitesi (L)	2,5
	CA çıkış kalitesi	ISO8528 G2
	Yük gerilimi (DC) (V)	12
	Yük akımı (DC) (A)	58.3
	Güç (DC) (W)	700
	Aşırı yükten koruma (DC)	Sigortasız koruma
Motor	Motor	R60-i
	Motor tipi	Tek silindirli, 4 zamanlı, pekiştirilmiş havalı soğutma, OHV
	Silindir hacmi (cc)	60
	Yakıt türü	Kurşunsuz benzin
	Kesintisiz işleyiş süresi (nominal güç ile) (h)	4
	Yağ kapasitesi (L)	0,31
	Buji model no.	ASRTC
	Başlatma biçimi	Geri tepmeli başlatma
Jeneratör	Uzunluk x genişlik x yükseklik (mm)	380×240×420
	Net ağırlık (kg)	13

11 PARÇALARIN SÖKÜLMESİ VE TASFİYESİ

11.1 Tükenmiş malzemelerin tasfiyesi

Makine, kurulumundan sonra ve normal çalışması sırasında çevre kirliliğine yol açmaz, ancak kullanıldığı tüm süre boyunca özel koşullarda biten veya bazı ıskarta malzeme türleri oluşur (örneğin mekanik parçaların yağlama gresi).

Bu malzemelerin tasfiyesi için her ülkede çevre koruma mevzuatları mevcuttur. Müşteri, ülkesindeki yasalar hakkında bilgi sahibi olmalı ve kullanılan ürünlerin, imalatçılarından talep edilebilen teknik bilgi formlarında verilen talimatlara ve yasalara uygun şekilde hareket etmelidir.



DİKKAT!

Mineral yağların veya yağlama/bakım için kullanılan greslerin tasfiyesi ile ilgili yasalara uyulmasını önemle hatırlatırız.



DİKKAT!

Yağ ve diğer maddelerin tasfiyesi ile ilgili ayrıntılı bilgi, bu maddelerin güvenlik bilgi formlarından bulunabilirler.

Zehirli atıkların tasfiyesinin toplama, nakliye, işleme (geri dönüşüm için gerekli dönüştürme işlemi) aşamaları ve toprağa boşaltılması, aşağıdaki ilkelerle düzenlenen ve kamuyu ilgilendiren bir faaliyettir:

- a) Toplumun ve bireylerin sağlık ve güvenliği için her türlü tehlikeden kaçınılmalıdır.
- b) Hijyen ve sağlık kurallarına uyulmalı ve her türlü hava, su, yer üstü ve yeraltı kirliliğinden kaçınılmalıdır.

Ekonomi ve verim kriterleri çerçevesinde, malzeme ve enerjinin geri kazanımı ve geri dönüşümü teşvik edilmelidir.

11.2 Özel atıklarla ilgili talimatlar

Endüstriyel proseslerin ürünü olan atıklar ve bozulmuş ve eski makine ve ekipmanların imhası sonucunda ortaya çıkan malzemeler özel atıklardır.

Özel, zararlı ve zehirli atıklar, doğrudan ya da yetkili şirket veya kuruluşlar aracılığıyla, kamu hizmetini idare eden anlaşmalı yerlere teslim edilmeleri suretiyle, atıkları üreten kişiler tarafından tasfiye edilir.

Her ülke/belediye bölge idaresine kendi sınırları içindeki atık tasfiyesi ile ilgili bütün bilgileri vermek zorundadır.



DİKKAT!

Ürünün sahibi tarafından yasalara aykırı şekilde imha edilmesi, yasalarca öngörülen ceza uygulamalarını beraberinde getirir.



DİKKAT!

“RAEE” 2012/19/UE Direktifine göre eğer satın alınan bileşen/ürün üzeri çizili tekerlekli bir çöp kutusu sembolü ile işaretlenmiştir, bu ürünün kullanım ömrü sonunda diğer atıklardan ayrı şekilde toplanması gerektiği anlamına gelir.

Kullanım ömrünün sonuna ulaşan iş bu bileşenin/ürünün ayrı toplanması üretici tarafından organize edilir ve yönetilir. Bu teçhizatı imha etmek isteyen kullanıcı üretici ile iletişime geçmelidir ve ekipmanın kullanım ömrünün sonunda ayrı şekilde toplanmasına izin vermek için uygulanan sistemi takip etmelidir. Ürünün geri dönüşüm, işleme veya uygun şekilde imhası amacıyla gereken şekilde ayrıştırılması, çevre ve sağlık üzerindeki olumsuz etkileri önlemeye yardımcı olur ve teçhizatın oluşturduğu malzemelerin yeniden kullanımına ve/veya geri dönüşümüne katkıda bulunur. Ürünün kullanıcı tarafından yasalara aykırı şekilde imha edilmesi, yasalarca öngörülen ceza uygulamalarını beraberinde getirir.



Hvala, ker ste izbrali generator Campagnola by RATO.

Ta priročnik vsebuje informacije o njegovi uporabi. Pred uporabo ga skrbno preberite. Z varnim in pravilnim upravljanjem lahko dosežete najboljše rezultate.

Vse informacije v tej publikaciji temeljijo na najnovejših informacijah o izdelkih, ki so bile na razpolago v času tiskanja. Vsebina tega priročnika se lahko zaradi revizij in drugih sprememb razlikuje od dejanskih delov.

Pridržujemo si pravico, da kadar koli in brez predhodnega obvestila ter brez kakršnih koli obveznosti uvedemo spremembe. Nobenega dela te publikacije ni dovoljeno razmnoževati brez pisnega dovoljenja našega podjetja.

Ta priročnik je treba jemati kot trajni del generatorja in mora biti priložen generatorju v primeru nadaljnje prodaje.

VARNOSTNA OPOZORILA



OBVESTILO!

Osebna varnost ter varnost vašega premoženja in premoženja drugih sta zelo pomembni. Pozorno preberite vsa sporočila, pred katerimi je simbol.



NEVARNOST!

Če navodil ne upoštevate, obstaja tveganje SMRTI ali resnih POŠKODB.



OPOZORILO!

Če navodil ne upoštevate, obstaja nevarnost SMRTI ali resnih POŠKODB.



POZOR!

Če navodil ne upoštevate, obstaja nevarnost POŠKODB.

OBVESTILO!

Če navodil ne upoštevate, lahko poškodujete generator ali drugo premoženje.

VARNOSTNA OPOZORILA	137
1 VARNOSTNI NAPOTKI	139
2 KJE SE NAHAJAJO POMEMBNE ETIKETE	141
3 OPIS	142
3.1 Nadzorna plošča.....	142
4 PREVERJANJE FUNKCIJ	143
4.1 Ventil za gorivo.....	143
4.2 Zagonska ročica.....	143
4.3 Lučka za olje (rdeča).....	143
4.4 Lučka za preobremenitev (rdeča).....	144
4.5 Pilotna lučka AC (zelena).....	144
4.6 Zaščita DC.....	144
4.7 Stikalo generatorja.....	144
4.8 Pametno stikalo (C).....	145
4.9 Pokrovček rezervoarja za gorivo.....	145
4.10 Gumb za odzračevanje zraka na pokrovčku rezervoarja za gorivo.....	145
4.11 Ozemljitveni terminal.....	145
5 PRIPRAVA	146
5.1 Gorivo.....	146
5.2 Natakanje goriva.....	146
5.3 Motorno olje.....	146
5.4 PREVERJANJE PRED UPORABO.....	147
6 DELOVANJE	147
6.1 Zagon motorja.....	147
6.2 Zaustavitev motorja.....	148
6.3 Priključek za izmenični tok (AC).....	148
6.4 Področje uporabe.....	149
7 VZDRŽEVANJE	150
7.1 Preverjanje svečke.....	151
7.2 Regulacija uplinjača.....	151
7.3 Zamenjava motornega olja.....	151
7.4 Filter za zrak.....	151
7.5 Zaslona dušilca zvoka in zaščite pred iskrenjem.....	152
7.6 Filter rezervoarja za gorivo.....	152
8 SHRANJEVANJE	153
8.1 Odvajanje goriva.....	153
9 REŠEVANJE TEŽAV	153
10 TEHNIČNE ZNAČILNOSTI	154
11 UNIČENJE IN ODSTRANJEVANJE SESTAVNIH DELOV	154
11.1 Odstranjevanje obrabljenih materialov.....	154
11.2 Navodila za posebne odpadke.....	155

1 VARNOSTNI NAPOTKI

Pred zagonom generatorja preberite in razumite ta uporabniški priročnik. S poznavanjem postopkov za varno delovanje generatorja se boste izognili morebitnim nesrečam.

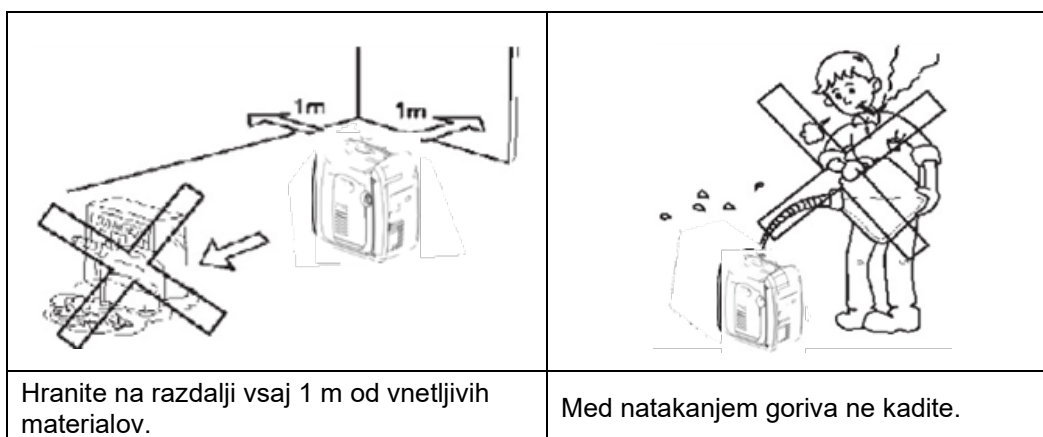
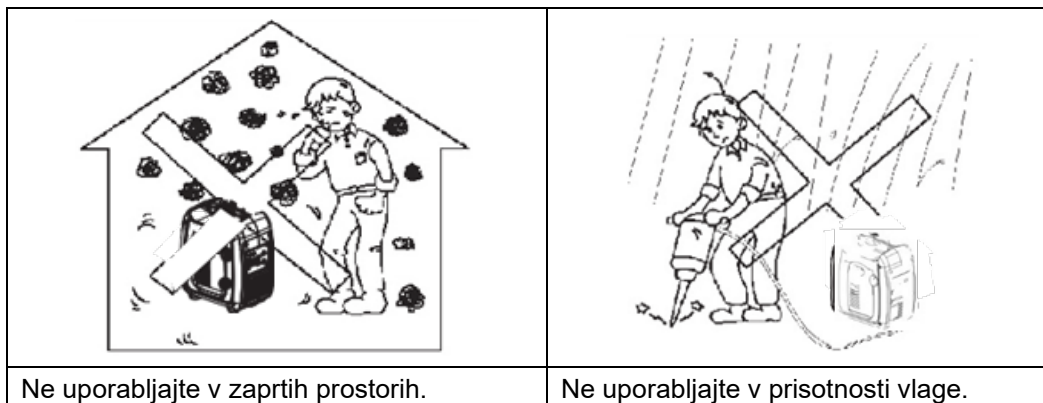

OBVESTILO!

Priklop na domače električno omrežje.

Če je treba generator priključiti na gospodinjstvo napajanje, mora povezavo izvesti poklicni električar ali druga oseba z ustreznim znanjem o elektriki.

Ko na generator priključite bremena, skrbno preverite, ali so električni priključki varni in zanesljivi. Nepravilen priklop lahko poškoduje generator ali privede do požara.

NEVARNOST!

Generator NI polnilnik baterij in ga sploh ni mogoče uporabiti za to, saj ni opremljen z nobenim sistemom za nadzor in zaščito proizvedenega toka.

Uporaba kot polnilec baterij NI DOVOLJENA IN PREPOVEDANA S STRANI PROIZVAJALCA, je nevarna in lahko poškoduje baterijo, generator, v primeru požara lahko povzroči hude telesne poškodbe.

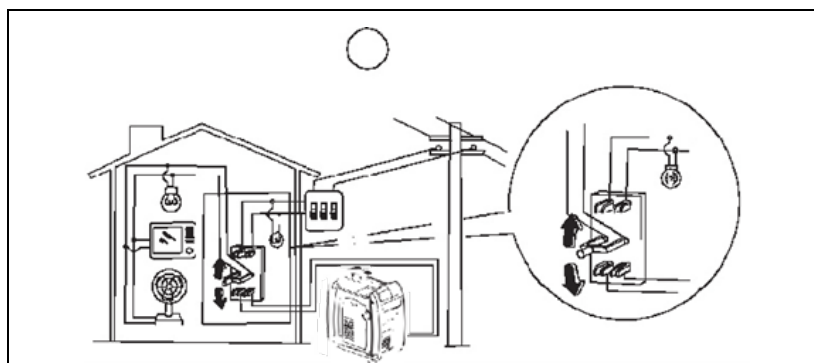
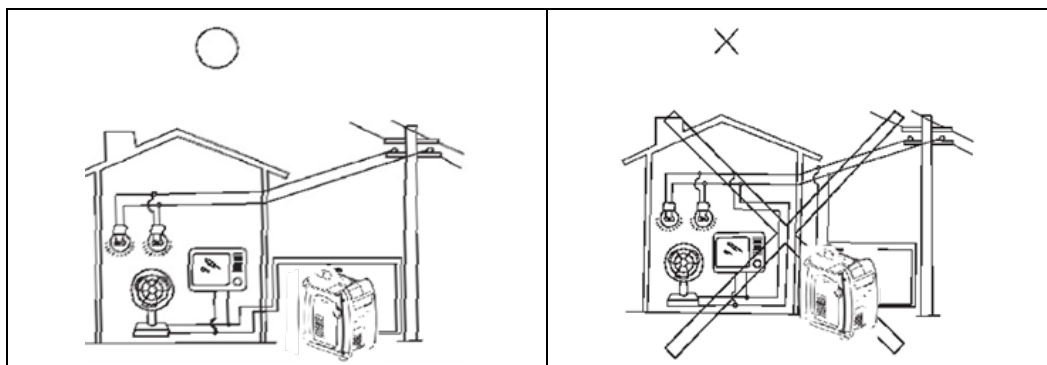

Ozemljitveni tokokrog generatorja

Da bi se izognili električnemu udaru zaradi slabe električne opreme ali nepravilne uporabe električne energije, mora biti generator ozemljen s kakovostnim izoliranim vodnikom.

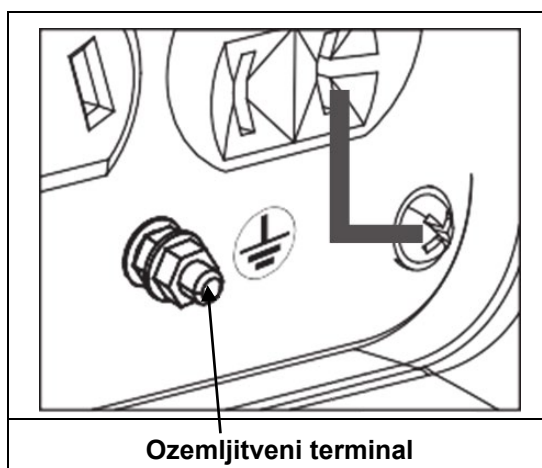

! OBVESTILO!

Prepričajte se, da se nadzorna plošča, dovod zraka in spodnja stran inverterja dobro hladijo in da na njih ni umazanije, blata ali vode. Zamašitev hladilnega zračnika lahko poškoduje motor, inverter ali alternator.

Pri premikanju, shranjevanju ali uporabi generatorja ne zalagajte z drugimi predmeti. To lahko poškoduje generator ali ogrozi varnost premoženja, če generator pušča.

2 KJE SE NAHAJAJO POMEMBNE ETIKETE





POZOR!

Pred uporabo tega stroja natančno preberite naslednje tabele.

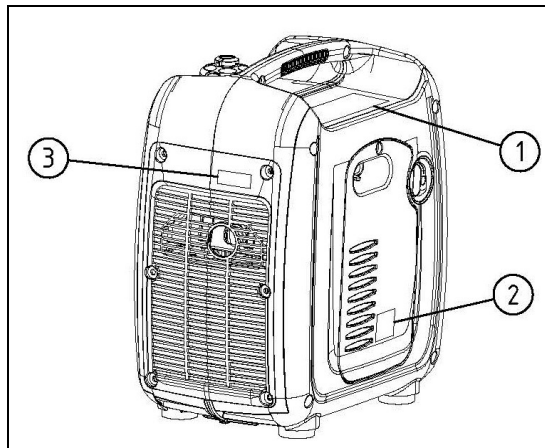
NASVET: Po potrebi vzdržujte ali zamenjajte etikete z navodili in varnostne etikete.



 WARNING	
1	<ul style="list-style-type: none">● Read the owner's manual and all labels before operating.● Only operate in well-ventilated areas. Exhaust gas contains poisonous carbon monoxide.● Check for spilled fuel or fuel leaks.● Stop engine before refueling.● Do not operate near flammable materials.● Electrocutation can occur if generator is used in rain, snow, or near water. Keep this unit dry at all times.● Electrocutation or property damage can occur. Do not connect this generator to any building's electrical system unless an isolation switch has been installed by a licensed electrician. Refer to the owner's manual.● When operating the generator:<ul style="list-style-type: none">Never place a partition or other barrier around the generator.Do not cover the generator with a box.Do not place any objects on the generator.● Turn the fuel tank cap air vent knob to "OFF" after the engine has completely cooled down.
2	
3	

3 OPIS

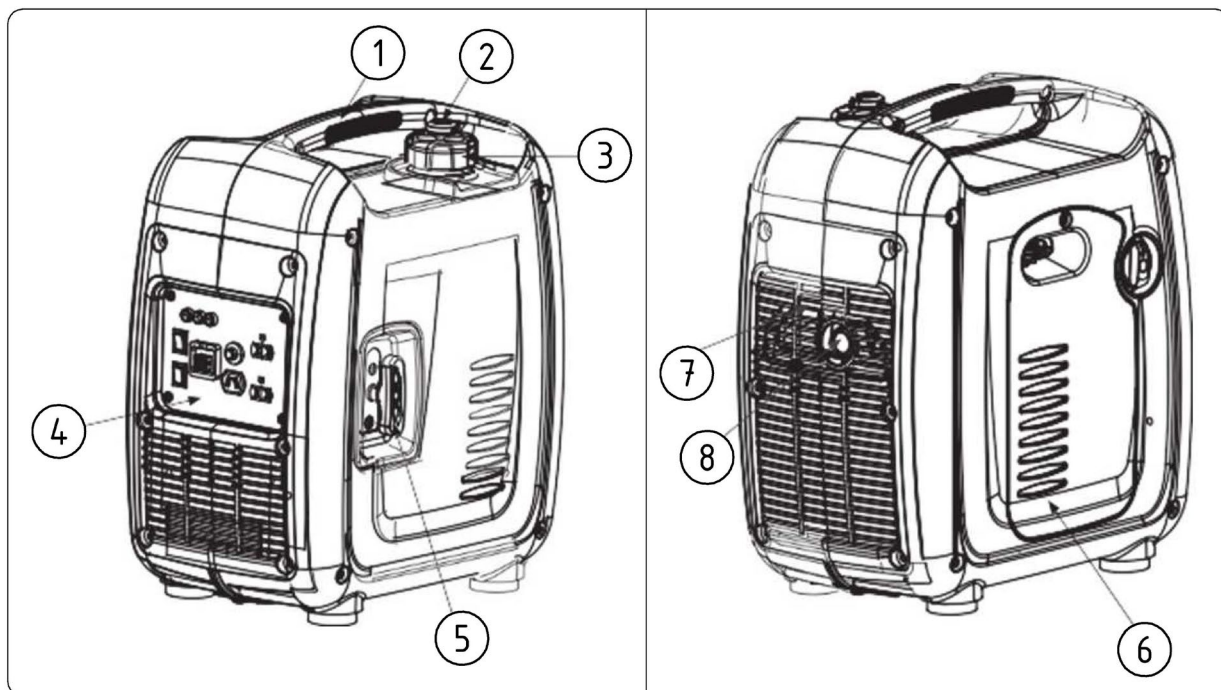

Pol.	Poimenovanje
1	Ročaj za prenašanje
2	Gumb za odzračevanje zraka na pokrovčku rezervoarja za gorivo
3	Pokrovček rezervoarja za gorivo
4	Nadzorna plošča
5	Zaganjač na poteg
6	Pokrovček za polnjenje olja
7	Vnos zraka
8	Dušilnik zvoka

3.1 Nadzorna plošča

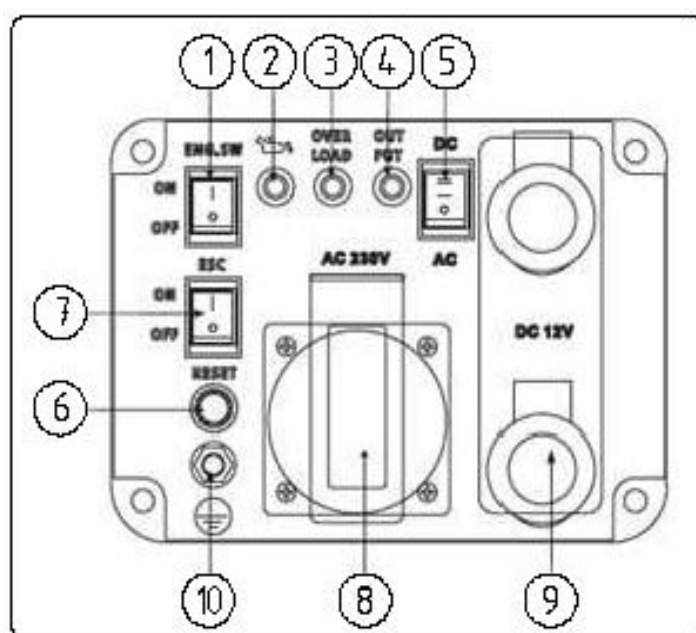

Pol.	Poimenovanje
1	Glavno stikalo
2	Lučka za olje
3	Lučka za preobremenitev
4	Pilotna lučka AC
5	Stikalo AC / DC (AC Izmenični tok, DC Enosmerni tok)
6	Ponastavitev AC
7	ESC (Inteligentno krmiljenje motorja)
8	Vtičnica AC
9	Priključki (+/-) DC
10	Ozemljitveni terminal

4 PREVERJANJE FUNKCIJ

4.1 Ventil za gorivo

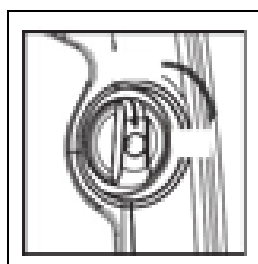

Ventil za gorivo uravnava pretok goriva iz rezervoarja v uplinjač. Po zaustavitvi motorja vrnite ročico v položaj "OFF".

4.2 Zagonska ročica

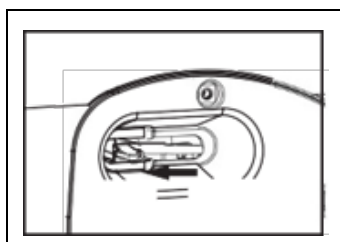

Zagonska ročica se uporablja za dovajanje obogatene mešanice goriva pri zagonu hladnega motorja. Po zagonu motorja zagonsko ročico počasi premaknite v položaj „ODPRTO“.

NASVET: Za zagon toplega motorja ročice za zagon ne potrebujete.

4.3 Lučka za olje (rdeča)



Ko raven olja pade pod minimum, se prižge signalna lučka ① in motor se avtomatsko ustavi. Če ne obnovite ravni olja, se motor ne bo ponovno zagnal.

NASVET: Če se motor ustavi ali ne zažene, nastavite stikalo motorja na „ON“ in potegnite zaganjač na poteg. Če lučka za olje nekaj sekund utripa, pomeni, da je motornega olja premalo. Dolijte olje in znova zaženite.

4.4 Lučka za preobremenitev (rdeča)

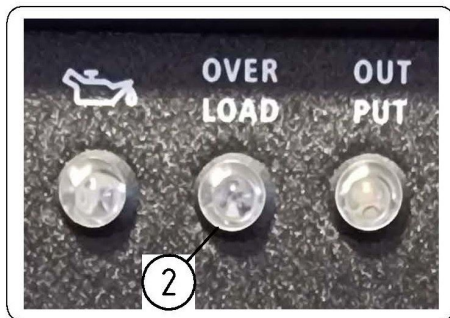

Indikator preobremenitve ① zasveti, ko je zaznana preobremenitev priključene električne naprave, ko se krmilnik inverterja pregreje ali ko se poveča izhodna izmenična napetost. Nato se sproži zaščita pred izmeničnim tokom, ki prekine proizvodnjo električne energije, za zaščito generatorja in morebitnih priključenih električnih naprav. Kontrolna lučka AC (zelena) bo ugasnila, lučka preobremenitve (rdeča) pa bo ostala prižgana, vendar se motor ne bo ustavil. Ko se prižge lučka za preobremenitev in se proizvodnja električne energije ustavi, ravnajte, kot sledi:

1. Izklopite vse priključene električne naprave in ustavite motor.
2. Zmanjšajte skupno moč priključenih električnih naprav na območje nazivne moči.
3. Preverite, ali ni ovir na dovodu hladilnega zraka in okoli krmilne enote. Če odkrijete blokade, jih odstranite.
4. Po preverjanju ponovno zaženite motor.

Nasvet: Pri uporabi električnih naprav, ki zahtevajo velik zagonski tok, kot sta kompresor ali potopna črpalka, lahko indikator preobremenitve sprva sveti nekaj sekund. Vendar to ni okvara.

4.5 Pilotna lučka AC (zelena)

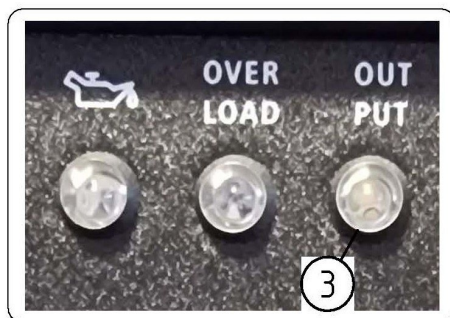

Pilotna lučka AC ③ se prižge, ko se motor zažene in proizvaja moč.

4.6 Zaščita DC

4.7 Stikalo generatorja

① - **On:** Zaženite generator

② - **Off:** Zaustavite generator

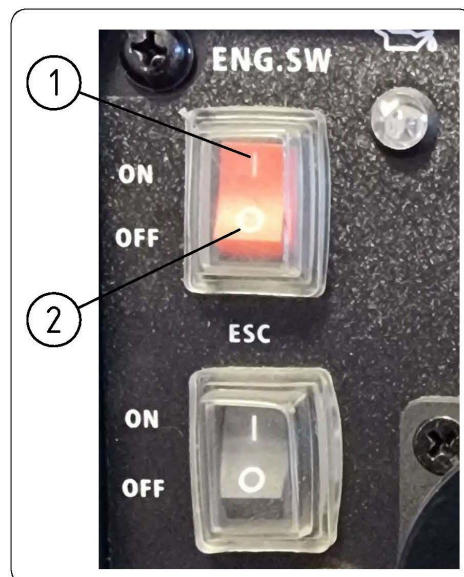

4.8 Pametno stikalo (C)

Pametna funkcija, ko je omogočena (stikalo je v položaju 1 „ON“), omogoča, da motor deluje v prostem teku z manjšo porabo goriva v pogojih brez obremenitve ali z majhno obremenitvijo; ko se obremenitev poveča, se poveča tudi število vrtljajev motorja, da se zagotovi večja moč.

Če je pametna funkcija onemogočena (stikalo je nastavljeno na 0 „OFF“), je motor vedno pri polni hitrosti, da takoj zagotovi največjo moč; ta funkcija je uporabna pri zagonu električnih orodij z visoko absorpcijo ob zagonu.

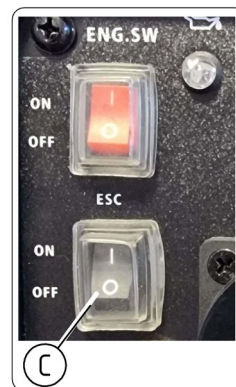

4.9 Pokrovček rezervoarja za gorivo

Odstranite pokrovček rezervoarja za gorivo tako, da ga obrnete v nasprotni smeri urinega kazalca.

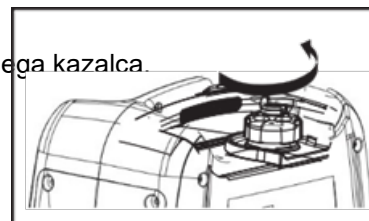

4.10 Gumb za odzračevanje zraka na pokrovčku rezervoarja za gorivo

Pokrovček rezervoarja za gorivo ② je opremljen z gumbom za odzračevanje ①, ki ustavi pretok goriva.

Gumb za zračenje mora biti nastavljen na „ON“. To bo omogočilo pretok goriva v uplinjač in delovanje motorja.

Ko motorja ne uporabljate, obrnite gumb za odzračevanje v položaj „OFF“, da ustavite pretok goriva.

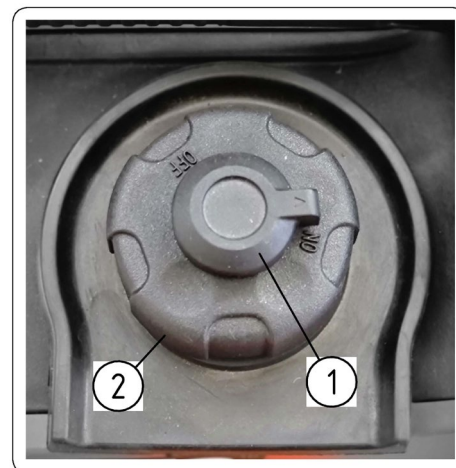

4.11 Ozemljitveni terminal

Ozemljitveni terminal ①



POZOR!

Priključite samo pri uporabi generatorja, priključenega na omrežje 220 V AC.



5 PRIPRAVA

5.1 Gorivo



POZOR!

Gorivo je zelo vnetljivo in strupeno. Pred polnjenjem natančno preberite „**VARNOSTNE INFORMACIJE**“.

- Rezervoarja za gorivo ne napolnite preveč, sicer se lahko pri segrevanju in širjenju goriva prelije.
- Ko napolnite rezervoar za gorivo, preverite, ali je pokrovček rezervoarja za gorivo dobro privit.



OBVESTILO!

- Razlito gorivo takoj obrišite z mehko, čisto in suho krpo, saj lahko gorivo poškoduje barvane površine ali plastične dele.
- Uporabljajte samo neosvinčeni bencin. Uporaba osvinčenega bencina povzroča hude poškodbe notranjih delov motorja.

5.2 Natakanje goriva



POZOR!

Gorivo je zelo vnetljivo in strupeno. Pred polnjenjem natančno preberite „**VARNOSTNE INFORMACIJE**“.

- Rezervoarja za gorivo ne napolnite preveč, sicer se lahko pri segrevanju in širjenju goriva prelije.
- Ko napolnite rezervoar za gorivo, preverite, ali je pokrovček rezervoarja za gorivo dobro privit



POZOR!

- Razlito gorivo takoj obrišite z mehko, čisto in suho krpo, saj lahko gorivo poškoduje barvane površine ali plastične dele.
- Uporabljajte samo neosvinčeni bencin. Uporaba osvinčenega bencina povzroča hude poškodbe notranjih delov motorja.



OBVESTILO!

Če želite natočiti gorivo, odstranite pokrovček rezervoarja za gorivo in napolnite rezervoar do rdeče ravni ①.

Priporočeno gorivo:

Neosvinčen bencin

Prostornina rezervoarja za gorivo:

Skupaj: 2,5 l

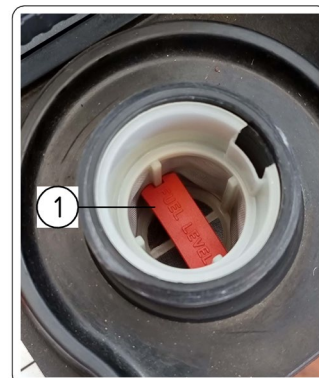

5.3 Motorno olje



POZOR!

Generator je dobavljen brez motornega olja. Motorja ne zaženite, dokler vanj ne natočite zadostne količine motornega olja.



- Generator postavite na ravno površino.

- Odstranite vijake ①, nato odstranite pokrov ②.
- Odstranite pokrovček za polnjenje olja ③.
- Natočite predpisano količino priporočenega motornega olja, nato ponovno namestite pokrovček za olje ③.
- Ponovno namestite pokrov ② in zategnite vijak ①.

Priporočeno motorno olje:	SAE SJ 15W-40
Priporočena stopnja motornega olja:	Tipa API Service SE ali višje kakovosti
Količina motornega olja:	0,31 l

5.4 PREVERJANJE PRED UPORABO



OBVESTILO!

- Pred zagonom generatorja preverite, ali so vsi njegovi deli nepoškodovani. Če je poškodovan, ga pred zagonom popravite; vitalne komponente lahko začnejo hitro in nepričakovano propadati, tudi če generatorja ne uporabljate.
- Za preverjanje stanja generatorja je odgovoren lastnik.
- Preverjanje pred uporabo je treba opraviti ob vsaki uporabi generatorja.
- Pred uporabo preverite raven **goriva** (glejte odst. 5.2) in ga po potrebi dolijte.
- Pred uporabo preverite raven **motornega olja** (glejte odst. 5.3) in ga po potrebi dolijte.
- Pred uporabo preverite, ali generator pušča olje.

V primeru nepravilnosti, ki niso opisane v tem priročniku, se obrnite na pooblaščen servisno delavnico.

6 DELOVANJE



POZOR!

Motorja nikoli ne zaganjajte v zaprtem prostoru, saj lahko emisije izpušnih plinov v kratkem času povzročijo izgubo zavesti in celo smrt. Motor upravljajte v dobro prezračevanem prostoru.

- Pred zagonom generatorja ne priklaplajte nobene električne naprave.
- Generator je dobavljen brez motornega olja, zato motorja ne zaženite, dokler vanj ne natočite navedene količine (glejte odst. 5.3).
- Med dolivanjem motornega olja generatorja ne nagibajte, saj lahko pride do prekomernega polnjenja in poškodbe motorja.
- Generator se lahko uporablja z nazivno izhodno obremenitvijo v standardnih atmosferskih pogojih:
 - Temperatura okolja: 25 °C
 - Barometrični tlak: 100 kPa
 - Relativna vlažnost: 30 %.
- Izhodna moč generatorja se spreminja glede na spremembo temperature, nadmorske višine (nižji zračni tlak na visoki nadmorski višini) in vlage.
- Moč generatorja se zmanjša, če so temperatura, vlažnost in nadmorska višina višji od standardnih atmosferskih pogojev.
- Pri uporabi v ozkih prostorih je treba zmanjšati obremenitev, saj to vpliva na hlajenje generatorja.

6.1 Zagon motorja

- 1- Gumb za odzračevanje nastavite na „On“ ①

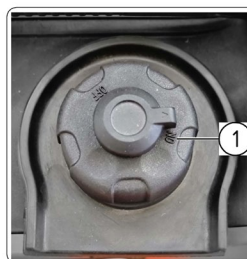

- 2- Obrnite pipo za gorivo ② v položaj **A**;
- 3- Ročico za zagon ③ premaknite v položaj **B**;

Generator je pripravljen za zagon.



OBVESTILO!

Če želite zagnati generator s toplim motorjem, mora ročica za zagon ostati v položaju „**OPEN**“.

- 4- Počasi povlecite ročaj ② zaganjalnika, dokler se ne zaskoči, nato ga hitro povlecite, da zaženete motor.



POZOR!

Trdno držite ročaj za prenašanje ①, da generator ne pade, ko vlečete zaganjalnik.

- 5- Po nekaj minutah delovanja motorja vrnite ročico za zagon v položaj **OPEN**.

6.2 Zaustavitev motorja

OBVESTILO!

- Pred zaustavitvijo motorja generatorja izklopite vse priključene električne naprave.
- Generatorsko stikalo obrnite v položaj „**OFF**“ (glejte odst. 4.7).
- Obrnite pipo za gorivo v položaj „**0**“ **CLOSE**.

Zagonski tokokrog je izklopljen, gorivo je zaprto.



- Ko se motor popolnoma ohladi, obrnite gumb za odzračevanje v položaj „**OFF**“ - 1.



6.3 Priključek za izmenični tok (AC)

POZOR!

- Prepričajte se, da so vse električne naprave izklopljene, preden jih priključite na generator.
- Pred priklopom na generator se prepričajte, da so vse električne naprave, vključno s kablji in vtiči, v dobrem stanju.
- Prepričajte se, da je skupna obremenitev v okviru nazivne moči generatorja.
- Prepričajte se, da je tok obremenitve vtičnice znotraj nazivnega toka vtičnice.

OPOMBA: če je generator priključen na omrežje 220 V AC, mora biti priključen tudi na ozemljitev prek ozemljitvenega terminala (glejte odst. 4.11).

**POZOR!**

Pri uporabi 12 V orodja mora biti pametno stikalo „ESC“ (glejte odst. 4.8) v položaju 1 „ON“.

6.4 Področje uporabe

**POZOR!**

Pri uporabi generatorja se prepričajte, da je skupna obremenitev v okviru nazivne moči generatorja. V nasprotnem primeru se lahko generator poškoduje.

AC				DC
Faktor moči	1	0,8- 0,95	0,4-0,75 (učinkovitost 0,85)	
lkW	<=1 000W	<=800W	<=400W	Nominalna napetost 12 V

**POZOR!**

- Moč uporabe kaže, kdaj se posamezna naprava uporablja samostojno.

PRIMER:

Nazivna izhodna moč generatorja		1.000 W
Frekvenca	Faktor moči	
AC	1,0	<= 1.000W
	0,8	<= 800W
DC	---	700 W(12 Vx58,3 A)

**POZOR!**

Indikator preobremenitve ② se prižge, ko skupna moč preseže podatke na tipski tablici (glejte pogl. 10).

**POZOR!**

- Ne preobremenjujte, skupna obremenitev vseh priključenih električnih naprav ne sme presežati podatkov na tablici z nazivnimi vrednostmi generatorja. Preobremenitev lahko poškoduje generator.
- Če napajate natančno opremo, elektronske krmilnike, osebne računalnike, mikroračunalniško opremo ali polnilnike akumulatorjev, bodite dovolj oddaljeni od generatorja, da se izognete električnim motnjam. Poskrbite tudi, da frekvence, ki jih oddaja generator, ne motijo drugih električnih in elektronskih naprav v bližini generatorja.
- Če je generator namenjen za napajanje medicinske opreme, se je treba najprej posvetovati s proizvajalcem ali medicinskim strokovnjakom.
- Določena električna oprema ali splošni elektromotorji imajo visoke zagonske tokove, zato jih ni mogoče uporabljati, tudi če spadajo v območja napajanja, navedena v zgornji tabeli. Za dodatne nasvete se obrnite na proizvajalca opreme.

7 VZDRŽEVANJE



POZOR!

- Preden izvajanjem kakršnega koli rednega vzdrževalnega posega, zaustavite generator.
- Vse vzdrževalne posege, ki niso opisani v tem priročniku, morajo biti opravljeni pri pooblaščenih serviserjih.



Redne vzdrževalne posege lahko opravljajo uporabniki.



POZOR!

- Motor je treba pravilno vzdrževati, da se zagotovi varno, varčno, brezhibno in okolju prijazno delovanje. Če želite, da bo vaš bencinski motor dobro deloval, ga morate redno vzdrževati. Natančno je treba upoštevati naslednji načrt vzdrževanja in rutinske postopke pregledov:

Komponenta	Frekvenca	Vsakič	Prvi mesec ali prvih 20 ur delovanja	Nato vsake 3 mesece ali vsakih 50 ur delovanja	Vsako leto ali vsakih 100 ur delovanja
Motorno olje	Preverjanje - dolivanje	✓			
	Zamenjava		✓	✓	
Zračni filter	Preverjanje	✓			
	Čiščenje		✓		
	Zamenjava			✓	
Vžigalna svečka	Preverjanje - nastavljanje				✓
	Zamenjava	Vsako leto ali vsakih 250 ur delovanja			
Zaščita pred iskrenjem	Čiščenje				
Delovanje v prostem teku (če je predvideno) *	Preverjanje - nastavljanje				✓
Rezervoar in filter za gorivo *	Čiščenje				✓
Cev za gorivo	Preverjanje	Vsaki 2 leti (po potrebi zamenjajte)			

* Te komponente mora vzdrževati in popravljati naš pooblaščen prodajalec.



POZOR!

Pred vzdrževanjem zaustavite motor. Motor postavite na ravno površino in odstranite pokrovček vžigalne svečke, da preprečite zagon motorja. Motorja ne uporabljajte v slabo prezračevanem prostoru ali v zaprtem območju. Poskrbite za dobro prezračevanje delovnega območja. Izpušni plini motorja lahko vsebujejo strupen CO, vdihavanje pa lahko povzroči šok, izgubo zavesti in celo smrt.



POZOR!

- Če bencinski motor pogosto deluje pri visokih temperaturah ali velikih obremenitvah, olje zamenjajte vsakih 25 ur.
- Če motor pogosto obratuje v prašnih ali drugih težkih razmerah, očistite element za filtriranje zraka vsakih 10 ur. Po potrebi vsakih 25 ur zamenjajte element za filtriranje zraka.
- Upoštevajte navedena obdobja vzdrževanja.
- Če predvideni rok za vzdrževanje motorja ni bil upoštevan, to storite čim prej.



POOBLAŠČENI SERVISER

Gre za delavnico, ki so jo navedli naši prodajalci in je pooblaščen za izvajanje popravil na izdelkih.

7.1 Preverjanje svečke



POZOR!

Vžigalna svečka je pomemben del motorja in jo je treba redno preverjati.

1. Snemite pokrov ①, odstranite pokrovček vžigalne sveče ②; s ključem, priloženim generatorju, odvijte vžigalno svečko z vrtenjem proti urnemu kazalcu.
2. Preverite, ali ni ostankov ogljika, in jih po potrebi odstranite z jekleno krtačo.
3. Preverite, ali vžigalna svečka ustreza prikazanemu modelu: standardna vžigalna svečka **A5RTC**

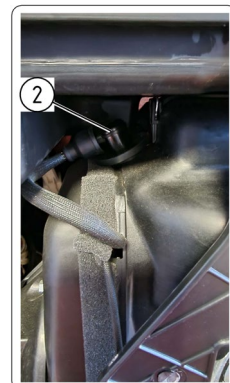

4. S kontrolnikom preverite razdaljo med elektrodama: 0,6-0,8 mm.
5. Ponovno namestite vžigalno svečko z navorom 12,5 Nm
6. Ponovno namestite pokrovček vžigalne svečke ② in pokrov ①.

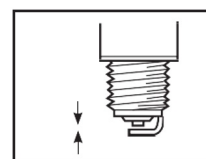

7.2 Regulacija uplinjača



POZOR!

Uplinjač je pomemben sestavni del motorja, njegovo vzdrževanje in nastavljanje mora opraviti pooblaščen servisni center.

7.3 Zamenjava motornega olja



POZOR!

- Motornega olja ne odvajajte takoj po zaustavitvi motorja. Olje je vroče, zato je treba z njim ravnati previdno, da ne pride do opeklin.
- Za zamenjavo olja glejte odstavek 5.3.



POZOR!

Med dolivanjem motornega olja generatorja ne nagibajte. To lahko privede do prekomernega polnjenja in poškodbe motorja.

7.4 Filter za zrak

- Generator postavite na ravno površino.
- Odstranite vijak ①, nato odstranite pokrov ②.
- Odstranite pokrov filtra ③.
- Odstranite filter ③.
- Gobico sperite z nevtralnimi detergentom in jo posušite.
- Namažite gobico in odstranite odvečno olje. Gobica mora biti navlažena, vendar ne sme kapljati.



POZOR!

Med tem postopkom ne ožemajte gobice. Lahko se strže.

- Vstavite gobast element v ohišje zračnega filtra in poskrbite, da se tesnilna površina gobastega elementa prilepi na zračni filter, da ne pride do uhajanja zraka.



POZOR!

Motorja nikoli ne smete zagnati brez gobastega elementa, saj lahko pride do prekomerne obrabe batov in valjev.

- Na prvotni položaj ponovno namestite pokrov ohišja filtra za zrak ③.
- Ponovno namestite pokrov ② in privijte vijak ①.

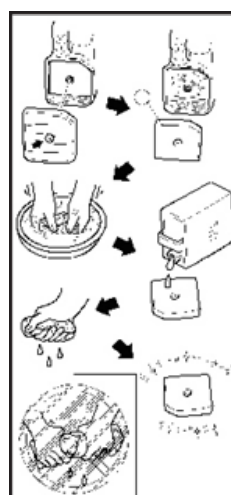

7.5 Zaslona dušilca zvoka in zaščite pred iskrenjem



POZOR!

Motor in dušilnik zvoka bosta po delovanju motorja zelo vroča. Med pregledom ali popravilom se s katerim koli delom telesa ali obleke ne dotikajte motorja in dušilnika zvoka, ko sta še vroča.

- Odstranite vijake ①, izvalcite pokrov ②.
- Odvijte sornik ③, odstranite kovinsko objemko dušilnika zvoka ④.
- Odstranite pokrovček dušilnika zvoka ⑤.
- S kovinsko krtačo očistite morebitne karbonske obloge na dušilniku zvoka.

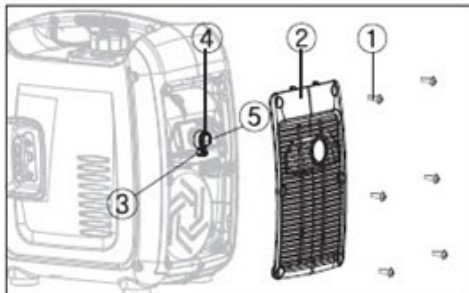

POZOR!

Pri čiščenju nežno uporabljajte kovinsko krtačo, da ne poškodujete dušilnika zvoka.

- Če je dušilnik zvoka poškodovan, ga zamenjajte.
- Ponovno namestite dušilnik zvoka ⑤, kovinsko objemko ④, pokrov ② in vijake ①.

7.6 Filter rezervoarja za gorivo



POZOR!

Nikoli ne uporabljajte bencina med kajenjem ali v bližini odprtega ognja.

- Odstranite pokrovček rezervoarja za gorivo in filter.
- Očistite filter z bencinom in ga ponovno namestite.
- Ponovno zaprite pokrov rezervoarja za gorivo.



POZOR!

Prepričajte se, da je pokrovček rezervoarja za gorivo dobro pritrjen.

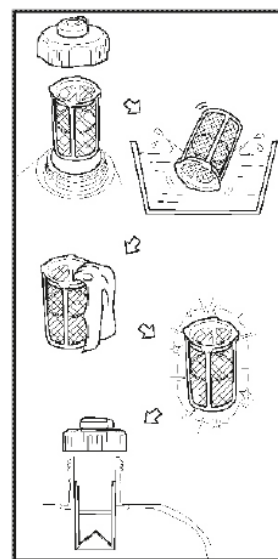

8 SHRANJEVANJE

OBVESTILO!

Če bo stroj dlje časa v mirovanju, bodo potrebni določeni preventivni postopki za zaščito stroja pred propadanjem.

8.1 Odvajanje goriva

- Obrnite pipo za gorivo v položaj „0“ **CLOSE**.
- Odstranite pokrovček rezervoarja za gorivo in filter. Odstranite gorivo iz rezervoarja in ga prelijte v odobreno posodo za bencin. Nato ponovno namestite pokrovček rezervoarja za gorivo.



POZOR!

Gorivo je izjemno gorljivo in strupeno. Razlito gorivo takoj obrišite z mehko, čisto in suho krpno, saj lahko gorivo poškoduje barvane površine ali plastične dele

OBVESTILO!

Zaženite motor in ga pustite delovati, dokler ne zmanjka preostalega goriva, ne priključite nobenih električnih naprav, to je treba storiti brez obremenitve. Trajanje delovanja brez obremenitve je odvisno od količine preostalega goriva v rezervoarju.

OBVESTILO!

Očistite zunanost generatorja in ga shranite na suhem, dobro prezračevanem in zaščitenem mestu.

9 REŠEVANJE TEŽAV

POZOR!

Vsa vzdrževalna dela mora opravljati mehanik-vzdrževalec.

TEŽAVA	VZROK	REŠITEV
Motor se ne zažene.	- V rezervoarju ni goriva. - V rezervoarju je gorivo.	- Napolnite rezervoar za gorivo. - Preverite položaj odzračevalnega ventila na pokrovu rezervoarja (glejte odst. 4.9) Preverite položaj pipe za gorivo (glejte odst. 4.1).
	Uplinjač je zamašen.	Generator odnesite na pooblaščen servis proizvajalca
Nizka raven motornega olja (prižge se opozorilna lučka)	Ni olja.	Dolijte olje v motor (glejte odst. 5.2).
Električno/mehansko nepravilno delovanje.	- Umazana ali mokra vžigalna svečka. - Okvarjen sistem vžiga.	- Očistite in posušite vžigalno svečko (glejte odst. 7.1). - Generator odnesite na pooblaščen servis proizvajalca.
Generator ne proizvaja energije.	- Varnostna naprava (zaščita pred enosmernim tokom) na „OFF“. - Pilotna lučka AC (zelena) se ugasne.	- Zaščito pred enosmernim tokom nastavite na "ON". - Ugasnite motor in ga ponovno zaženite.

10 TEHNIČNE ZNAČILNOSTI

Model		1 kW
Generator	Vrsta	Tihi inverter
	Nazivna frekvenca (Hz)	50/60
	Nazivna napetost (V)	110/120/220/230/240
	Nazivna izhodna moč (kW)	1,0
	Faktor moči	1
	Filter rezervoarja za gorivo (L)	2,5
	Kakovost izhoda AC	ISO8528 G2
	Napetost polnjenja (DC) (V)	12
	Tok polnjenja (DC) (A)	58,3
	Moč (DC) (W)	700
	Zaščita pred preobremenitvijo (DC)	Zaščita brez varovalk
Motor	Motor	R60-i
	Tip motorja	Enocilinderski, štiritačni, prisilno zračno hlajeni, OHV
	Prostornina (cc)	60
	Tip goriva	Neosvinčen bencin
	Čas neprekinjenega delovanja (pri nazivni moči) (h)	4
	Prostornina olja (L)	0,31
	Št. modela svečke	ASRTC
	Način zagona	Zagon s samodejnim navijanjem
Generator	Dolžina x širina x višina (mm)	380×240×420
	Neto teža (kg)	13

11 UNIČENJE IN ODSTRANJEVANJE SESTAVNIH DELOV

11.1 Odstranjevanje obrabljenih materialov

Naprava, potem ko je sestavljena in normalno deluje, ne onesnažuje okolja, sicer pa v celotnem času njene uporabe nastajajo določeni odpadni in iztrošeni materiali pod posebnimi pogoji (na primer mast za mazanje mehanskih delov).

Za uničenje teh materialov v vsaki državi obstajajo posebni okoljevarstveni predpisi. Kupec mora poznati veljavno zakonodajo svoje države in jo mora spoštovati v skladu z navodili, ki so podana na tehničnih listih uporabljenih izdelkov, katere lahko pridobi pri proizvajalcu.



POZOR!

Treba je spoštovati veljavno zakonodajo s področja odstranjevanja mineralnih olj in maziv za mazanje/vzdrževanje.



POZOR!

Dodatne informacije o načinu odstranjevanja olj in snovi najdete v varnostnih listih samih izdelkov.

Odstranjevanje strupenih odpadkov oz. zbiranje, prevoz, obdelava (mišljena kot predelava za ponovno uporabo), hramba in deponiranje na tla, sodijo pod dejavnosti javnega pomena, pri čemer je treba upoštevati naslednja splošna načela:

- a) Treba je preprečiti katerokoli škodo ali nevarnost za zdravje, neogroženost in varnost skupnosti in posameznikov.
- b) Treba je zagotoviti spoštovanje higiensko-zdravstvenih zahtev in preprečiti tveganja onesnaževanja voda, zraka, tal in podzemlja.

Treba je skrbeti, ob upoštevanju kriterijev gospodarnosti in učinkovitosti, za sistem zbiranja in recikliranja materialov in energije.

11.2 Navodila za posebne odpadke

Pod posebne odpadke sodijo odpadki, ki nastanejo pri industrijskih delih, in materiali, ki nastanejo pri razstavljanju obrabljenih ali starih naprav in strojev.

Za odstranjevanje posebnih odpadkov, tudi strupenih in škodljivih, so zadolženi proizvajalci samih odpadkov, neposredno ali posredno preko namenskih podjetij ali pooblaščenih ustanov ali tako, da jih predajo javnim komunalnim službam, s katerimi imajo sklenjen poseben dogovor.

Vsaka država/občina mora posredovati regionalnemu oddelku vse razpoložljive podatke o odstranjevanju odpadkov na tem ozemlju.



POZOR!

Nezakonito uničenje izdelka s strani uporabnika se kaznuje v skladu z veljavnimi predpisi.



POZOR!

Glede na Direktivo „OEE0“ 2012/19/EU, je treba, če je kupljena komponenta/izdelek označen z naslednjim simbolom prečrtanega zabojnika na kolesih, ta izdelek ob koncu njegove življenjske dobe ločiti od ostalih odpadkov.

Ločeno zbiranje te komponente/izdelka ob koncu življenjske dobe organizira in izvaja proizvajalec. Uporabnik, ki se želi znebiti te naprave, se mora obrniti na proizvajalca in upoštevati sistem, ki ga le-ta uporablja za omogočanje ločenega zbiranja naprave ob koncu njene življenjske dobe. Ustrezno ločeno zbiranje odpadkov za nadaljnjo okoljevarstveno reciklažo, obdelavo ali uničenje obrabljene naprave pomaga pri preprečevanju možnih negativnih vplivov na okolje in zdravje in omogoča ponovno uporabo in/ali recikliranje materialov, iz katerih je sestavljena naprava. Nezakonito uničenje izdelka s strani uporabnika se kaznuje v skladu z veljavnimi lokalnimi predpisi.



Hvala Vam što ste odabrali generator tvrtke Campagnola by RATO.

Ovaj priručnik sadrži informacije o tome kako ga koristiti. Pozorno ga pročitajte prije uporabe. Rad na siguran i ispravan način vam može pomoći u postizanju najboljih rezultata.

Sve informacije iz ove publikacije temelje se na najnovijim informacijama o proizvodima koje su dostupne u trenutku tiskanja. Sadržaj ovog priručnika se može razlikovati od stvarnih dijelova priručnika zbog revizija i drugih izmjena.

Naša tvrtka zadržava pravo izmjene u bilo kojem trenutku bez prethodne obavijesti i bez ikakvih obveza. Nijedan dio ove publikacije se ne smije umnožavati bez pisanog dopuštenja naše tvrtke.

Ovaj priručnik se mora smatrati stalnim dijelom Generatora i mora pratiti Generator u slučaju preprodaje.

UPOZORENJA O SIGURNOSTI

OBAVIJEST!

Osobna sigurnost i sigurnost Vaše i tuđe imovine je vrlo važna. Pozorno pročitajte poruke ispred kojih se nalazi simbol.

OPASNOST!

Prisutan je rizik od SMRTI ili teških OZLJEDA ako se ne poštuju upute.

UPOZORENJE!

Prisutna je opasnost od SMRTI ili teških OZLJEDA ako se ne poštuju upute.

POZOR!

Prisutna je opasnost od teških OZLJEDA ako se ne poštuju upute.





OBAVIJEST!

Generator ili druga imovina bi se mogli oštetiti ako se ne poštuju upute.

UPOZORENJA O SIGURNOSTI	156
1 SIGURNOSNE UPUTE	158
2 POLOŽAJ VAŽNIH ETIKETA	160
3 OPIS	161
3.1 Upravljačka ploča	161
4 NADZOR FUNKCIJA	162
4.1 Ventil za gorivo	162
4.2 Ručica za pokretanje	162
4.3 Kontrolna lampica za ulje (crvena)	162
4.4 Kontrolna lampica za preopterećenje (crvena)	163
4.5 Pilotna lampica AC (zelena)	163
4.6 Zaštita DC	163
4.7 Prekidač Generatora	163
4.8 Pametni prekidač (C)	164
4.9 Čep spremnika za gorivo	164
4.10 Ručica za ispuštanje zraka na čepu spremnika goriva	164
4.11 Stezaljka za uzemljenje	164
5 PRIPREMA	165
5.1 Gorivo	165
5.2 Opskrba gorivom	165
5.3 Motorno ulje	165
5.4 PROVJERA PRIJE UPORABE	166
6 RAD	166
6.1 Pokretanje motora	166
6.2 Zaustavljanje motora	167
6.3 Priključivanje u izmjeničnoj struji (AC)	167
6.4 Područje primjene	168
7 ODRŽAVANJE	169
7.1 Pregled svjećice	170
7.2 Prilagođavanje rasplinjača	170
7.3 Zamjena motornog ulja	170
7.4 Zračni filter	170
7.5 Zaklon prigušivača i odvodnika iskri	171
7.6 Filter spremnika za gorivo	171
8 ČUVANJE	172
8.1 Pražnjenje goriva	172
9 RJEŠAVANJE PROBLEMA	172
10 TEHNIČKE SPECIFIKACIJE	173
11 UNIŠTAVANJE I ZBRINJAVANJE KOMPONENTI	173
11.1 Zbrinjavanje istrošenih materijala	173
11.2 Smjernice za posebni otpad	174

1 SIGURNOSNE UPUTE

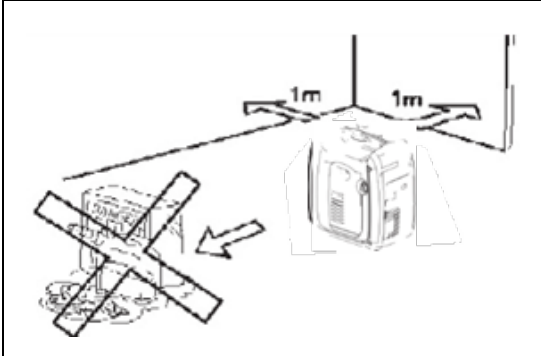
Morate pročitati i razumjeti ovaj priručnik za uporabu prije puštanja u rad generatora. Poznavanje sigurnih radnih postupaka generatora će Vam pomoći u izbjegavanju mogućih nezgoda.

	
Ne koristite u zatvorenom prostoru.	Ne koristite u prisutnosti vlage.
	
Čuvajte na udaljenosti od najmanje 1 m od zapaljivih materijala.	Nemojte pušiti za vrijeme punjenja gorivom.
	
Zaustavite motor prije punjenja gorivom.	

OBAVIJEST!

Priključivanje na opskrbu električnom energijom za kućanstvo.

Ako se generator treba priključiti na opskrbu električnom energijom za kućanstvo, priključak mora obaviti stručni električar ili neka druga osoba koja posjeduje prikladna znanja iz područja struje.

Kad su opterećenja priključena na generator, pažljivo provjerite jesu li električni priključci sigurni i pouzdani. Neprikladan priključak može uzrokovati oštećenja na Generatoru ili prouzročiti požar.

OPASNOST!

Generator **NIJE** punjač baterija i ne može se uopće koristiti za to, jer nije opremljen nikakvim sustavom kontrole i zaštite za isporučenu struju.

Korištenje kao punjač baterija **NIJE DOZVOLJENO I ZABRANJENO OD STRANE PROIZVOĐAČA**, opasno je i može oštetiti bateriju, generator, u slučaju požara može izazvati ozbiljne ozljede.

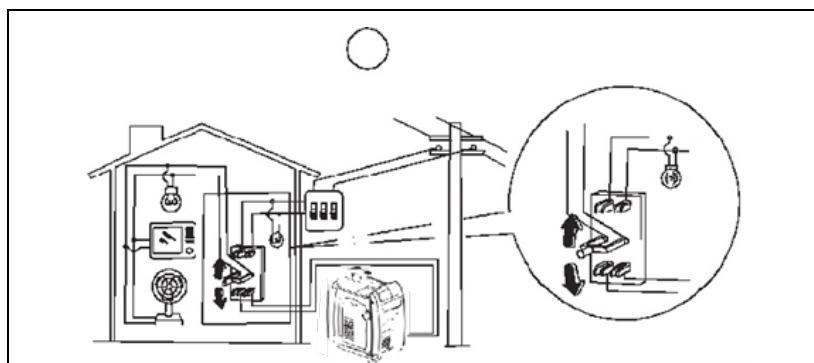
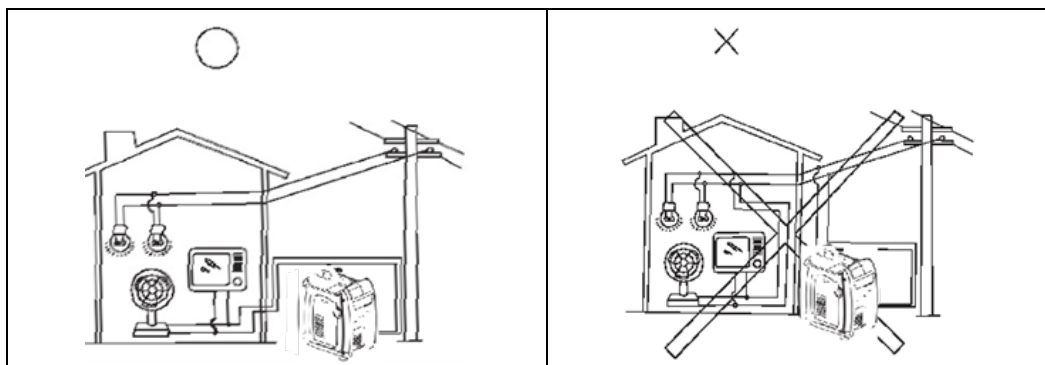

Sustav uzemljenja Generatora

Radi izbjegavanja strujnih udara prouzročenih lošim električnim uređajima ili nepravilnom uporabom struje, generator se mora povezati na uzemljenje pomoću kvalitetnog izoliranog vodiča.

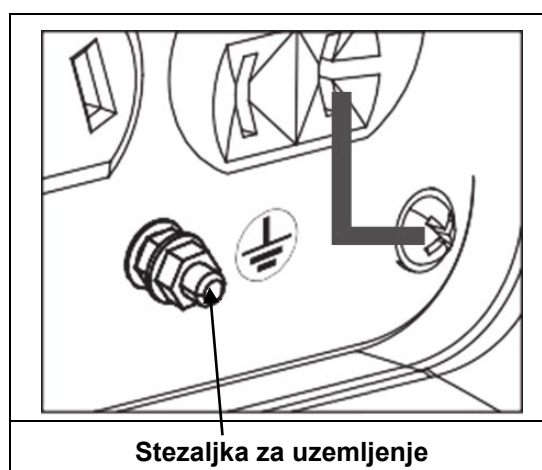

OBAVIJEST!

Uvjerite se da su se upravljačka ploča, dovod zraka i donja strana invertera dobro ohladili i da nisu prisutne nečistoće, blato i voda. Ako se odvod za hlađenje blokira, moglo bi doći do oštećenja motora, invertera ili alternatora.

Nemojte slagati generator s drugim predmetima u slučaju premještanja, stavljanja u stanje mirovanja ili rada jedinice. To bi moglo oštetiti Generator ili ugroziti sigurnost imovine ako se pojave ispuštanja na Generatoru.

2 POLOŽAJ VAŽNIH ETIKETA





POZOR!

Pažljivo pročitajte sljedeće tablice prije uporabe stroja.

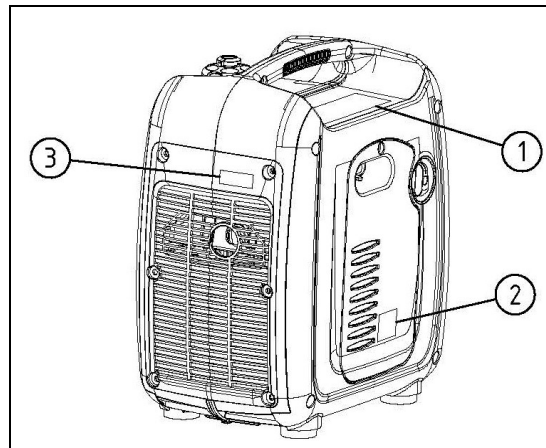
SAVJET: Ako je potrebno, održavajte ili zamijenite etikete s uputama i one koje se odnose na sigurnost.



 WARNING	
1	<ul style="list-style-type: none">● Read the owner's manual and all labels before operating.● Only operate in well-ventilated areas. Exhaust gas contains poisonous carbon monoxide.● Check for spilled fuel or fuel leaks.● Stop engine before refueling.● Do not operate near flammable materials.● Electrocutation can occur if generator is used in rain, snow, or near water. Keep this unit dry at all times.● Electrocutation or property damage can occur. Do not connect this generator to any building's electrical system unless an isolation switch has been installed by a licensed electrician. Refer to the owner's manual.● When operating the generator:<ul style="list-style-type: none">Never place a partition or other barrier around the generator.Do not cover the generator with a box.Do not place any objects on the generator.● Turn the fuel tank cap air vent knob to "OFF" after the engine has completely cooled down.
2	
3	

3 OPIS

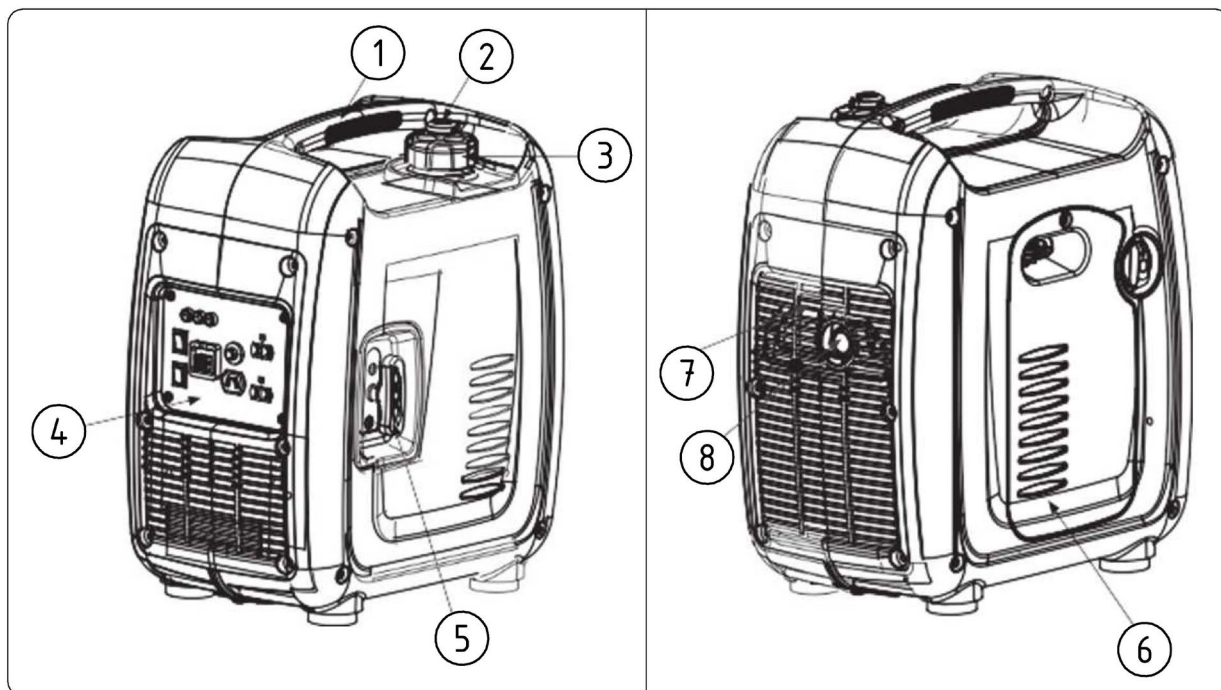

Pol.	Naziv
1	Ručka za prenošenje
2	Ručica za ispuštanje zraka na čepu spremnika goriva
3	Čep spremnika goriva
4	Upravljačka ploča
5	Trzajni pokretač
6	Čep za punjenje ulja
7	Dovod zraka
8	Prigušivač

3.1 Upravljačka ploča

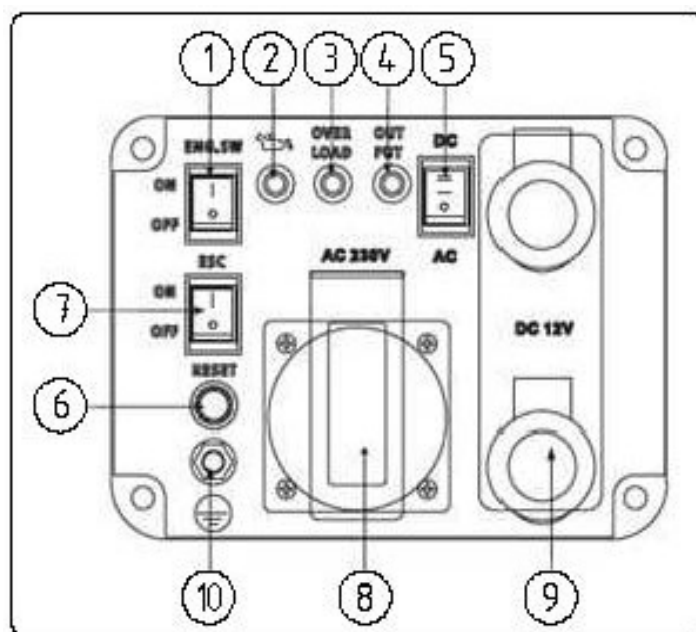

Pol.	Naziv
1	Glavni prekidač
2	Kontrolna lampica za ulje
3	Kontrolna lampica za preopterećenje
4	Pilotna kontrolna lampica AC
5	Prekidač AC/DC (AC Izmjenična struja, DC Istosmjerna struja)
6	AC Reset
7	ESC (Pametna kontrola motora)
8	Utičnica AC
9	Priključci (+/-) DC
10	Stezaljka za Uzemljenje

4 NADZOR FUNKCIJA

4.1 Ventil za gorivo

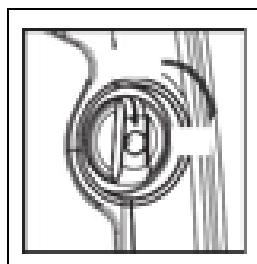

Ventil za gorivo nadzire protok goriva iz spremnika prema rasplinjaču. Uvjerite se da ste vratili ručicu na „OFF“ (isklj.) nakon zaustavljanja motora.

4.2 Ručica za pokretanje

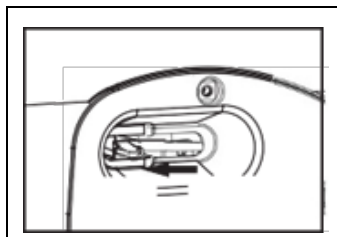

Ručica za pokretanje služi opskrbljivanju obogaćenom mješavinom goriva kada se pokreće hladan motor. Polako stavite ručicu za pokretanje u položaj „OTVORENO“ nakon što ste pokrenuli motor.

SAVJET: Pokretač nije potreban za pokretanje toplog motora.

4.3 Kontrolna lampica za ulje (crvena)



Kad se razina ulja spusti ispod minimuma, uključuje se kontrolna lampica ① i motor se automatski zaustavlja. Ako se ne oporavi razina ulja, motor se neće ponovno pokrenuti.

SAVJET: Ako se motor blokira i ako se ne pokreće, stavite prekidač motora na „ON“ (uklj.) i zatim povucite pokretač trzajem. Ako kontrolna lampica za ulje treperi nekoliko sekundi, znači da je ulje motora nedovoljno. Nadopunite uljem i ponovno pokrenite.

4.4 Kontrolna lampica za preopterećenje (crvena)

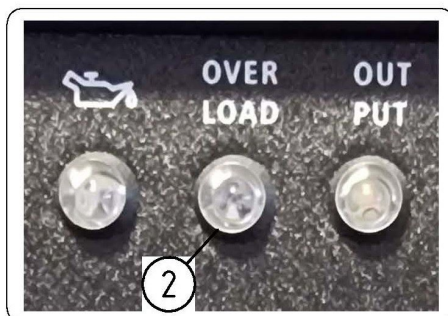

Kontrolna lampica za preopterećenje ② se uključuje kad se prepozna preopterećenje nekog priključenog električnog uređaja, kad se upravljačka jedinica invertera pregrije ili kad je izlazni AC napon povećan. Stoga će se uključiti AC zaštita i prekinuti će proizvodnju energije radi zaštite Generatora i eventualno priključenih električnih uređaja. Pilotna lampica AC za Izmjeničnu struju (zelena) se isključuje dok kontrolna lampica za preopterećenje (crvena) ostaje uključena, ali se motor ne zaustavlja.

Kad se uključi kontrolna lampica za preopterećenje i kad se proizvodnja električne energije zaustavi, obavite sljedeće:

1. Isključite sve priključene električne uređaje i zaustavite motor.
2. Smanjite sveukupnu snagu priključenih električnih uređaja unutar raspona nazivne snage.
3. Provjerite da nema prepreka na ulazu zraka za hlađenje i oko jedinice za nadzor; ako primijetite zapreke, uklonite ih.
4. Nakon obavljene kontrole, ponovno pokrenite motor.

Savjet: Kontrolna lampica za preopterećenje se može uključiti nekoliko sekundi na početku, kad se koriste električni uređaji koji zahtijevaju značajnu struju pokretanja, kao na primjer kompresor ili potopna pumpa. Unatoč tome, ne radi se o neispravnom radu.

4.5 Pilotna lampica AC (zelena)

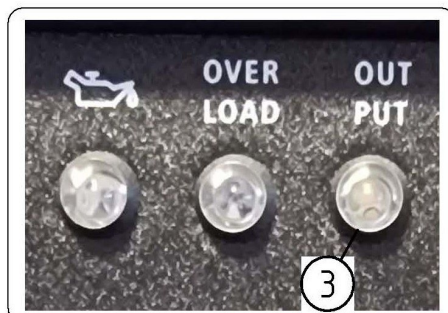

Pilotna lampica AC ① se uključuje kad se motor pokrene i kad proizvodi snagu.

4.6 Zaštita DC

4.7 Prekidač Generatora

① - On (Uklj.): Pokrenite Generator

② - Off (Isklj.): Zaustavite Generator

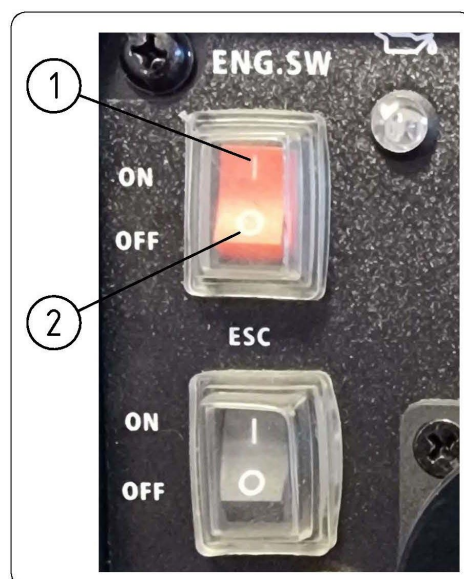

4.8 Pametni prekidač (C)

Pametna funkcija, ako je omogućena (prekidač **1** na „ON“/uklj.) omogućava okretanje motora na minimumu sa smanjenom potrošnjom goriva, u stanju bez ili s malim opterećenjem; pri povećanju opterećenja, povećavaju se također i okretaji motora radi pružanja veće snage.

S onemogućenom pametnom funkcijom (prekidač na **0** „OFF/isklj.“) motor je uvijek na maksimalnom broju okretaja kako bi odmah pružio maksimalnu snagu; ova je funkcija korisna kad se moraju pokrenuti električni uređaji s velikom početnom potrošnjom.

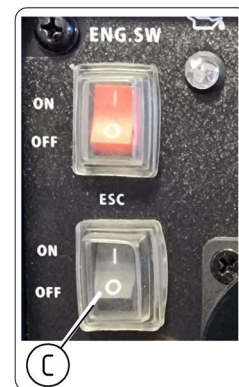

4.9 Čep spremnika za gorivo

Uklonite čep spremnika za gorivo okretanjem u smjeru suprotnom od kazaljke na satu.

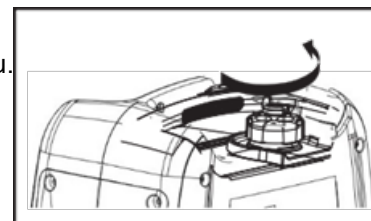

4.10 Ručica za ispuštanje zraka na čepu spremnika goriva

Čep spremnika za gorivo ② je opremljen ručicom za ispuštanje zraka radi ① zaustavljanja protoka goriva.

Ručica za ispuštanje zraka mora stajati na „ON (uklj.)“. Time će se omogućiti dotok goriva u rasplinjač i rad motora.

Kad motor nije u uporabi, okrenite ručicu za ispuštanje zraka na „OFF“ (isklj.) radi zaustavljanja protoka goriva.

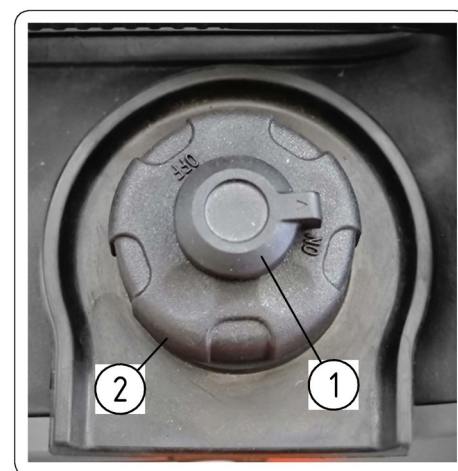

4.11 Stezaljka za uzemljenje

Stezaljka za uzemljenje ①



POZOR!
Povežite isključivo ako koristite Generator povezan na mrežu s izmjeničnom strujom od 220 V.



5 PRIPREMA

5.1 Gorivo



POZOR!

Gorivo je vrlo zapaljivo i otrovno. Pažljivo pročitajte „SIGURNOSNE INFORMACIJE“ prije punjenja.

- Nemojte pretjerano puniti spremnik za gorivo jer bi u suprotnom moglo doći do prelijevanja kad se gorivo zagrije i širi.
- Nakon punjenja spremnika gorivom, uvjerite se da je čep dotičnog spremnika dobro zavrnut.



OBAVIJEST!

- Odmah očistite proliveno gorivo mekom, čistom i suhom krpom jer bi gorivo moglo oštetiti lakirane površine ili plastične dijelove.
- Koristite samo bezolovni benzin. Uporaba benzina s olovom uzrokuje teška oštećenja na unutarnjim dijelovima motora.

5.2 Opskrba gorivom



POZOR!

Gorivo je vrlo zapaljivo i otrovno. Pažljivo pročitajte „SIGURNOSNE INFORMACIJE“ prije punjenja.

- Nemojte pretjerano puniti spremnik goriva jer bi u suprotnom moglo doći do prelijevanja kad se gorivo zagrije i širi.
- Nakon punjenja spremnika goriva, uvjerite se da je čep dotičnog spremnika dobro zavrnut



POZOR!

- Odmah očistite proliveno gorivo mekom, čistom i suhom krpom jer bi gorivo moglo oštetiti lakirane površine ili plastične dijelove.
- Koristite samo bezolovni benzin. Uporaba benzina s olovom uzrokuje teška oštećenja na unutarnjim dijelovima motora.



OBAVIJEST!

Za opskrbu gorivom, uklonite čep spremnika za gorivo i napunite spremnik do crvene razine ①.

Preporučeno gorivo:

Bezolovni benzin

Obujam spremnika za gorivo:

Sveukupni: 2.5L

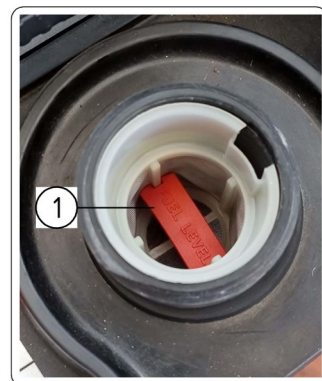

5.3 Motorno ulje



POZOR!

Generator se isporučuje bez motornog ulja. Nemojte pokretati motor sve dok ga ne napunite dovoljnom količinom motornog ulja.



- Postavite Generator na ravnu površinu.
- Uklonite vijke ①, zatim uklonite poklopac ②.
- Uklonite čep za punjenje ulja ③.
- Ulijte navedenu količinu preporučenog motornog ulja, zatim stavite i pritegnite čep za punjenje ulja ③.
- Ponovno montirajte čep ②, stegnite vijke ①.

Preporučeno motorno ulje:	SAE SJ 15W-40
Preporučena gradacija motornog ulja:	Tip API Service SE ili veća
Količina motornog ulja:	0.31 L

5.4 PROVJERA PRIJE UPORABE

OBAVIJEST!

- Prije pokretanja Generatora, uvjerite se da su svi njegovi dijelovi neoštećeni, ako su oštećeni, popravite ih prije puštanja u rad, vitalne komponente mogu početi brzo i neočekivano propadati, čak i ako se Generator ne koristi.
- Za provjeru stanja Generatora je zadužen vlasnik.
- Morate obaviti provjere prije uporabe prilikom svake nove uporabe Generatora.
- Prije uporabe provjerite razinu **Goriva** (pogledajte odl. 5.2) ako je potrebno, nadopunite gorivom.
- Prije uporabe provjerite razinu **Ulja u motoru** (pogledajte odl. 5.3; ako je potrebno, nadopunite gorivom).
- Prije uporabe, provjerite da iz Generatora ne curi ulje.

U slučaju nepravilnosti koje nisu opisane u ovom priručniku, obratite se ovlaštenoj radionici.

6 RAD

POZOR!

Nemojte nikada pokretati motor u zatvorenom prostoru, budući da bi emisije ispušnih plinova mogle uzrokovati gubitak svijesti, čak i smrt, u kratkom vremenu. Motor mora raditi na dobro prozračenom mjestu.

- Prije pokretanja Generatora, nemojte priključivati nijedan električni uređaj.
- Generator se isporučuje bez motornog ulja; nemojte pokretati motor sve dok niste napunili označenom količinom ulja (pogledajte odl. 5.3).
- Nemojte naginjati Generator dok nadopunjujete motornim uljem jer bi to moglo dovesti do pretjeranog punjenja i oštećenja motora.
- Generator se može koristiti s nazivnim izlaznim opterećenjem u standardnim atmosferskim uvjetima:
 - Temperatura okolnog zraka: 25°C
 - Barometarski tlak: 100kPa
 - Relativna vlažnost: 30%.
- Snaga Generatora se mijenja ovisno o temperaturi, nadmorskoj visini (niži tlak zraka na većoj nadmorskoj visini) i vlažnosti.
- Snaga Generatora se smanjuje kad su temperatura, vlažnost i nadmorska visina viši od standardnih atmosferskih uvjeta.
- Opterećenje se mora smanjiti kada se koristi u skućenim prostorima, jer to utječe na hlađenje Generatora.

6.1 Pokretanje motora

- 1- Stavite ručicu za ispuštanje zraka na „On (Uklj.)” ①

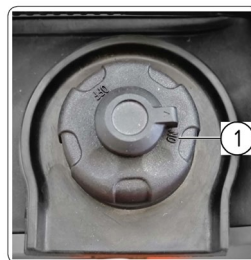

- 2- Okrenite slavinu za gorivo ② u položaj A;
- 3- Pomaknite upravljačku ručicu Pokretača ③ u položaj B;

Generator je spreman za pokretanje.



OBAVIJEST!

Za pokretanje Generatora s toplim motorom, upravljačka ručica pokretača mora ostati u otvorenom položaju „**OPEN**“.

- 4- Polako povucite samonamotavajuću ručicu ② za pokretanje sve dok se ne aktivira, i potom je brzo povucite kako biste pokrenuli motor.



POZOR!

Čvrsto uhvatite ručku za prenošenje ① kako biste izbjegli da Generator padne kad povučete samonamotavajuću napravu za pokretanje.

- 5- Nakon nekoliko minuta rada motora, vratite upravljačku ručicu pokretača u otvoreni položaj **OPEN**.

6.2 Zaustavljanje motora

OBAVIJEST!

- Prije zaustavljanja motora Generatora, isključite sve priključene električne uređaje.
- Stavite prekidač Generatora u položaj „**OFF (isklj.)**“ (pogledajte odl. 4.7).
- Okrenite slavinu za gorivo u položaj „**0**“ **CLOSE (zatvoreno)**.

Sustav za uključivanje je isključen, gorivo je zatvoreno.



- Nakon što se motor potpuno ohladio, okrenite ručicu za ispuštanje zraka na „**OFF**“ (isklj.) - 1.



6.3 Priključivanje u izmjeničnoj struji (AC)

POZOR!

- Uvjerite se da su svi električni uređaji isključeni prije njihovog priključivanja na Generator.
- Uvjerite se da su svi električni uređaji, uključujući kabele i utične konektore, u dobrom stanju prije priključivanja na Generator.
- Provjerite je li ukupno opterećenje unutar nazivne snage Generatora.
- Provjerite je li struja opterećenja utičnice unutar nazivne struje utičnice.

NAPOMENA: ako je Generator spojen na 220 V AC mrežu, Generator također mora biti spojen na uzemljenje preko stezaljke za uzemljenje (pogledajte odl. 4.11).



**POZOR!**

Kad se koriste alati od 12 V, pametni prekidač „ESC“ (pogledajte odl. 4.8) mora obavezno biti u položaju 1 („ON (UKLJ.)“).

6.4 Područje primjene

**POZOR!**

Kada koristite Generator, provjerite je li ukupno opterećenje unutar nazivne snage Generatora. U suprotnom se mogu pojaviti oštećenja na Generatoru.

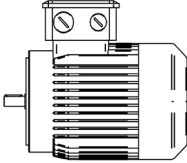
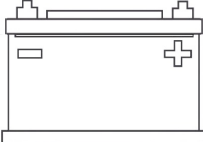
AC				
Faktor snage	1	0.8- 0.95	0.4-0.75 (Učinkovitost 0,85)	DC
IkW	<=1 000W	<=800W	<=400W	Nazivni napon 12V

**POZOR!**

- Snaga primjene označava kada se svaki uređaj koristi sam.

PRIMJER:

Izlazna nazivna snaga Generatora		1.000 w
Frekvencija	Faktor snage	
AC	1,0	<= 1.000W
	0,8	<= 800W
DC	---	700W(12Vx58.3A)

**POZOR!**

Kontrolna lampica za preopterećenje ② se uključuje kad sveukupna snaga prekorači podatke s pločice (pogledajte pogl. 10).

**POZOR!**

- Nemojte preopteretiti, ukupno opterećenje svih priključenih električnih uređaja ne smije premašiti podatke na pločici Generatora. Preopterećenje oštećuje Generator.
- Kad se napaja oprema za točnost, elektronski kontrolni uređaji, osobna računala, elektronska računala, uređaji koji se temelje na mikro računalima ili punjači baterija, držite Generator na dovoljnoj udaljenosti kako bi se izbjegle električne smetnje. Također provjerite da frekvencije koje emitira Generator ne ometaju druge električne i elektroničke uređaje koji se nalaze u njegovoj blizini.
- Ako Generator mora napajati medicinske uređaje, morate se prije toga za savjet obratiti proizvođaču ili medicinskom stručnjaku.
- Neki električni uređaji ili električni motori opće namjene imaju velike početne struje i stoga se ne mogu koristiti, čak i ako su unutar raspona napajanja navedenim u gornjoj tablici. Obratite se proizvođaču uređaja za dodatne savjete.

7 ODRŽAVANJE



POZOR!

- Prije izvođenja bilo koje operacije redovnog održavanja, zaustavite Generator.
- Sve radnje održavanja koje nisu obuhvaćene ovim priručnikom moraju se obavljati u ovlaštenim servisnim centrima.



Operacije redovnog održavanja mogu izvoditi rukovatelji.



POZOR!

- Motor se mora prikladno održavati kako bi se osigurao siguran, ekonomičan i rad bez problema, koji je ujedno i ekološki prihvatljiv.

Kako bi očuvali benzinski motor u dobrom radnom stanju, morate obavljati redovno održavanje. Morate se pažljivo pridržavati sljedećeg programa održavanja i postupaka rutinske kontrole:

Komponenta	Učestalost	Svaki put	Tijekom prvog mjeseca ili prvih 20 sati rada	Kasnije, svaka 3 mjeseca ili svakih 50 sati rada	Svake godine ili svakih 100 sati rada
Motorno ulje	Provjera - Nadopuna	✓			
	Zamjena		✓	✓	
Zračni filter	Provjera	✓			
	Čišćenje		✓		
	Zamjena			✓	
Svjećica za paljenje	Provjera-prilagođavanje				✓
	Zamjena	Svake godine ili svakih 250 sati rada			
Odvodnik iskri	Čišćenje				
Rad na minimumu (ako je dio opreme) *	Provjera-prilagođavanje				✓
Spremnik i filter goriva *	Čišćenje				✓
Cijev za gorivo	Provjera	Svake 2 godine (promijeniti ako je potrebno)			



POZOR!

Zaustavite motor prije obavljanja održavanja. Stavite motor na ravnu površinu i uklonite kapicu svjećice kako bi spriječili pokretanje motora.

Nemojte uključivati motor u prostoru s lošom ventilacijom ili na zatvorenom. Uvjerite se da se u radnom području održava dobra ventilacija. Ispušni sustav motora može sadržavati otrovni CO plin čije udisanje može izazvati šok, gubitak svijesti pa čak i smrt



POZOR!

- Ako benzinski motor radi često na visokim temperaturama ili s teškim opterećenjima, zamijenite ulje svakih 25 sati.
- Ako motor radi često u prašnjavim uvjetima ili u drugih teškim okolnostima, očistite filtrirajući element za zrak svakih 10 sati. Ako je potrebno, zamijenite filtrirajući element za zrak svakih 25 sati.
- Poštujte navedena razdoblja održavanja.
- Ako se niste pridržavali predviđenog roka za održavanje motora, pobrinite se za njegovo održavanje što prije.



OVLAŠTENA RADIONICA

To je radionica koju su naveli naši prodavatelji, ovlaštena za popravljanje proizvoda.

7.1 Pregled svjeće



POZOR!

Svjećica je važna komponenta motora, koju bi trebalo povremeno pregledavati.

1. Uklonite poklopac ①, uklonite čep svjećice ②; pomoću ključa koji je dio opreme Generatora, odvijte svjećicu okretanjem u smjeru suprotnom od kazaljke na satu.
2. Provjerite da nema ostataka ugljika i eventualno ih uklonite pomoću čelične četke.
3. Provjerite da svjećica odgovara navedenom modelu: standarda svjećica **A5RTC**

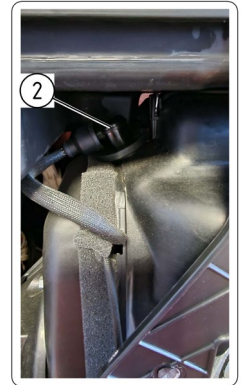

4. Pomoću mjernog listića, provjerite udaljenost između elektroda: 0,6-0,8 mm.
5. Ponovno montirajte svjećicu momentom pritezanja od 12,5 Nm
6. Ponovno montirajte čep svjećice ② i poklopac ①.

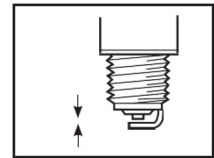

7.2 Prilagođavanje rasplinjača



POZOR!

Rasplinjač je važna komponenta motora; njegovo održavanje i prilagođavanje mora obavljati ovlaštenu servisnu agenciju.

7.3 Zamjena motornog ulja



POZOR!

- Izbjegavajte prazniti motorno ulje odmah nakon zaustavljanja motora. Ulje je toplo i njime se mora rukovati pažljivo kako bi se izbjegle opekline.
- Za zamjenu ulja pogledajte odlomak 5.3.



POZOR!

Nemojte naginjati generator kad dodajete motorno ulje. To bi moglo uzrokovati pretjerano punjenje i oštećenje motora.

7.4 Zračni filter

- Postavite Generator na ravnu površinu.
- Uklonite vijak ①, zatim uklonite poklopac ②.
- Uklonite poklopac filtra ③.
- Uklonite filter ③.
- Operite spužvasti element neutralnim sredstvom za pranje i osušite ga.
- Nauljite spužvasti element i uklonite višak ulja. Spužvasti element se mora navlažiti ali ne smije kapati.



POZOR!

Tijekom ove operacije nemojte stiskati spužvasti element kako biste ga iscijedili. Mogao bi se potrgati.

- Unesite spužvasti element u tijelo zračnog filtra i uvjerite se da nepropusna površina spužvastog elementa osigurava prijanjanje zračnog filtra tako da nema propuštanja zraka.



POZOR!

Motor ne smije nikada raditi bez spužvastog elementa; to bi moglo dovesti do pretjeranog habanja klipa i cilindra.

- Ponovno montirajte poklopac tijela filtra za zrak ③ u izvorni položaj.
- Ponovno montirajte poklopac ② i pritegnite vijak ①.

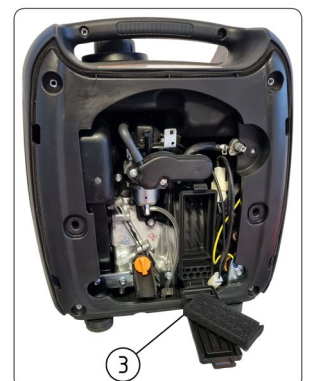
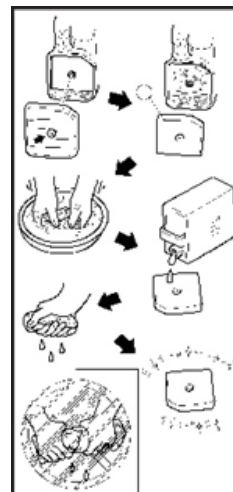

7.5 Zaklon prigušivača i odvodnika iskri



POZOR!

Motor i prigušivač će biti vrlo topli nakon rada motora. Izbjegavajte dirati motor i prigušivač dok su topli bilo kojim dijelom tijela ili odjećom, za vrijeme pregleda ili popravaka.

- Uklonite vijke ①, izvucite poklopac ②.
- Otpustite svornjak ③, uklonite metalnu obujmicu prigušivača ④.
- Uklonite kapicu prigušivača ⑤.
- Metalnom četkom očistite eventualne naslage ugljika koje se nalaze na prigušivaču.

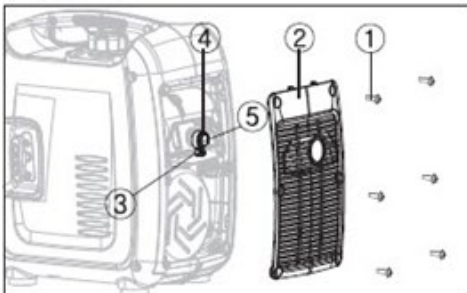

POZOR!

Tijekom čišćenja, nježno koristite metalnu četku kako bi izbjegli oštećenja prigušivača.

- Ako je prigušivač oštećen, zamijenite ga.
- Ponovno montirajte prigušivač ⑤, metalnu obujmicu ④, poklopac ② i vijke ①.

7.6 Filtar spremnika za gorivo



POZOR!

Nemojte nikada koristiti benzin ako pušite ili ako se nalazite u blizini otvorenog plamena.

- Uklonite čep spremnika za gorivo i filter.
- Očistite filter benzinom i ponovno ga montirajte.
- Zatvorite ponovno čep spremnika za gorivo.



POZOR!

Uvjerite se da je čep spremnika za gorivo dobro pritegnut.

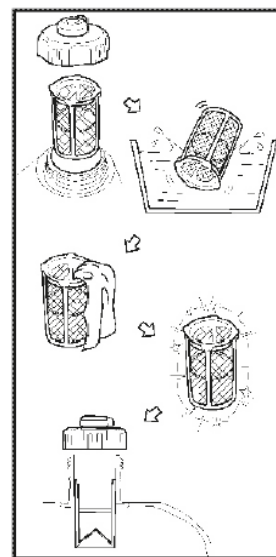

8 ČUVANJE

OBAVIJEST!

Ako se stroj stavi u mirovanje na dulje vrijeme, bit će potrebni neki preventivni postupci kako bi se zaštitio od propadanja.

8.1 Pražnjenje goriva

- Okrenite slavinu za gorivo u položaj „0“ **CLOSE (zatvoreno)**.
- Uklonite čep spremnika za gorivo i filter. Izvadite gorivo iz spremnika tako da ga ulijete u odobreni spremnik za benzin. Zatim ponovno montirajte čep spremnika za gorivo.



POZOR!

Gorivo je vrlo zapaljivo i opasno. Odmah očistite proliveno gorivo mekom, čistom i suhom krpom jer bi gorivo moglo oštetiti lakirane površine ili plastične dijelove

OBAVIJEST!

Pokrenite motor i ostavite ga da radi sve dok se ne potroši preostalo gorivo; nemojte priključivati električne uređaje; taj se postupak mora obavljati na prazno. Trajanje rada na prazno ovisi o preostaloj količini goriva u spremniku.

OBAVIJEST!

Očistite vanjske dijelove Generatora; čuvajte ga na suhom mjestu koje je dobro prozračeno i zaštićeno.

9 RJEŠAVANJE PROBLEMA

POZOR!

Sve izvanredne zahvate održavanja mora izvoditi radnik zadužen za mehaničko održavanje.

POTEŠKOĆA	UZROK	RJEŠENJE
Motor se ne pokreće.	- Nema goriva u spremniku. - Ima goriva u spremniku.	- Napunite spremnik gorivom. - Provjerite položaj ventila za ispuštanje na čepu spremnika (pogledajte odl. 4.9) Provjerite položaj slavine za gorivo (pogledajte odl. 4.1).
	Rasplinjač je začepljen.	Odnosite Generator u Proizvođačev ovlašteni centar za potporu.
Razina motornog ulja niska (uključuje se kontrolna lampica)	Nedostaje ulje.	Nadopunite ulje u motor (pogledajte odl. 5.2).
Električni/mehanički neispravan rad.	- Svjećica je prljava ili mokra. - Sustav za uključivanje nije ispravan.	- Očistite i osušite svjećicu (pogledajte odl. 7.1). - Odnosite Generator u Proizvođačev ovlašteni centar za potporu.
Generator ne proizvodi energiju.	- Sigurnosni uređaj (zaštita DC) na „OFF“ (isklj). - Pilotna lampica AC (zelena) se isključuje.	- Stavite zaštitu DC na „ON“ (uklj). - Isključite motor, i zatim ga ponovno pokrenite.

10 TEHNIČKE SPECIFIKACIJE

Model		1kW
Generator	Tip	Prigušeni inverter
	Nazivna frekvencija (Hz)	50/60
	Nazivni napon (V)	110/120/220/230/240
	Nazivna izlazna snaga (kW)	1,0
	Faktor snage	1
	Obujam spremnika za gorivo (L)	2,5
	Kvaliteta izlaza AC	ISO8528 G2
	Napon punjenja (DC) (V)	12
	Struja punjenja (DC) (A)	58.3
	Snaga (DC) (W)	700
	Zaštita od preopterećenja (DC)	Zaštita bez osigurača
Motor	Motor	R60-i
	Tip motora	Četverotaktni, jednocilindrični motor, prisilno hlađenje zrakom, OHV
	Obujam (cc)	60
	Tip goriva	Bezolovni benzin
	Vrijeme neprestanog rada (na nazivnoj snazi) (h)	4
	Kapacitet ulja (L)	0,31
	Br. modela svjeće	ASRTC
	Način pokretanja	Samonamotavajuća naprava za pokretanje
Generator	Duljina x širina x visina (mm)	380×240×420
	Neto težina (kg)	13

11 UNIŠTAVANJE I ZBRINJAVANJE KOMPONENTI

11.1 Zbrinjavanje istrošenih materijala

Stroj, nakon ugradnje i u svom normalnom radu, ne izaziva onečišćenje okoliša, ali tijekom cijelog razdoblja uporabe nastaju neke vrste otpada ili istrošenih materijala u određenim uvjetima (npr. mast za podmazivanje mehaničkih dijelova).

Za zbrinjavanje ovih materijala u svakoj državi postoje specifični propisi očuvanja okoliša. Klijent je obvezan poznavati važeće zakone u vlastitoj zemlji i raditi tako da se pridržava dotičnog zakonodavstva sukladno smjernicama navedenim na tehničkim listovima proizvoda u uporabi koje može zatražiti od Proizvođača.



POZOR!

Podsjećamo vas da se pridržavate važećih zakona u vezi zbrinjavanja mineralnih ulja ili masti koje se koriste za podmazivanje/održavanje.



POZOR!

Više informacija o načinima zbrinjavanja ulja i drugih tvari, možete pronaći na sigurnosnom listu samih tvari.

Zbrinjavanje toksičnog otpada tijekom faza prikupljanja, prijevoza, obrade (u smislu operacije prerade potrebne za uporabu), te odlaganja i ispuštanja predstavljaju radnje od javnog interesa i podliježu poštivanju sljedećih općih načela:

- a) Mora se izbjegavati bilo koja šteta ili opasnost u pogledu zdravlja i sigurnosti zajednice i pojedinaca.
- b) Mora se jamčiti usklađenost s higijenskim i zdravstvenim zahtjevima te se mora izbjeći svaki rizik od onečišćenja zraka, vode, tla i podzemlja.

Moraju se promicati sustavi uporabe i recikliranja materijala i energije, uz poštivanje ekonomskih kriterija i onih učinkovitosti.

11.2 Smjernice za posebni otpad

Ostaci industrijskih procesa i materijali nastali uništavanjem dotrajale i zastarjele opreme i strojeva su poseban otpad.

Za zbrinjavanje posebnog otpada, čak i štetnog i otrovnog, zaduženi su proizvođači samog otpada, izravno ili preko tvrtki ili ovlaštenih tijela te se isti moraju uručiti subjektima koji upravljaju javnom uslugom s kojima je sklopljen posebni sporazum.

Svako država/općina dužna je regiji dostaviti sve dostupne informacije o odlaganju otpada na svom teritoriju.



POZOR!

Nezakonito zbrinjavanje proizvoda od strane vlasnika dovodi do primjene administrativnih kazni predviđenih važećim zakonom.



POZOR!

Sukladno Direktivi „OEE0“ 2012/19/EU, ako je kupljena komponenta/proizvod označena/označen sljedećim znakom prekrížene kante za otpatke s kotačima, znači da se proizvod na završetku svojeg korisnog vijeka mora zbrinuti odvojeno od ostalog otpada.

Odvojenim zbrinjavanjem otpada ove komponente/proizvoda na kraju svog korisnog vijeka upravlja Proizvođač. Korisnik koji se želi riješiti ove opreme će se stoga morati obratiti proizvođaču i slijediti sustav koji je proizvođač odabrao za omogućavanje odvojenog zbrinjavanja uređaja na kraju korisnog vijeka. Odgovarajuće odvojeno zbrinjavanje otpada za daljnje slanje odloženog uređaja na recikliranje, obradu i ekološki održivo zbrinjavanje, pridonosi izbjegavanju mogućih negativnih posljedica na okolinu i zdravlje te pospješuje uporabu i/ili recikliranje materijala koji sačinjavaju opremu. Nezakonito zbrinjavanje proizvoda od strane korisnika dovodi do primjene kazni predviđenih lokalnim važećim zakonima.



Chongqing Rato Technology Co.,Ltd.

Indirizzo di fabbrica: Zona B, Shuang fu Industry Park, Jiangjin District, Chongqing, Cina
Tel: +86 23 85553441 Fax: +86 23 85553450
E- mail: ratoservice @ rato.cc (servizio di consulenza) CAP: 402247 Web: www.rato.cc
Made in China

CAMPAGNOLA S.r.l.

Via Lazio, 21-23 • 40069 Zola Predosa – Bologna – Italy
Tel. + 39/051753500 – Fax + 39/051752551
Internet: www.campagnola.it – e-mail: star@campagnola.it